**NOTE: WHERE THERE IS MORE THAN ONE JUMP WITHIN A BRANCHPOINT BOX,
THE JUMPS ARE TO BE APPLIED IN ORDER FROM THE TOP.**

**NOTE: IN DATE OR OTHER NUMERICAL COMPARISONS (e.g., FOR LAST JUMP AT J501
BRANCHPOINT), RESPONSES OF DK, RF, OR EMPTY (WHEN THE QUESTION WAS NOT
ASKED) EVALUATE AS 0/ZERO. THEREFORE, A DATE FOR WHICH NO YEAR WAS GIVEN
WILL ALWAYS BE LESS THAN ONE FOR WHICH A YEAR WAS GIVEN.**

NOTE ABOUT COLORS:

ALL QUESTION TEXT IN BLACK IS FOR THE CORE INTERVIEW.

ALL QUESTION TEXT IN FUCHSIA IS FOR THE EXIT INTERVIEW. ALSO IN FUCHSIA IS
ALL OTHER TEXT THAT IS SPECIFIC TO THE EXIT INTERVIEW BUT NOT TO THE
CORE.

OTHERWISE, BLACK TEXT FOR CODEFRAMES, INTERVIEWER INSTRUCTIONS, JUMPS AND
BRANCHPOINTS, ETC. CAN APPLY TO BOTH THE CORE AND THE EXIT INTERVIEW
UNLESS SPECIFIED OTHERWISE OR THERE IS AN EXIT ALTERNATIVE.

ON A BLACK-AND-WHITE HARD COPY OF THE DOCUMENT, THE FUCHSIA TEXT WILL APPEAR
SOMEWHAT LIGHTER THAN THE ORIGINAL BLACK.

NOTE ABOUT EXIT INTERVIEW Rs:

ANY NEW SPOUSE/PARTNER THAT AN EXIT INTERVIEW R ACQUIRED SINCE HIS/HER LAST
INTERVIEW IS IGNORED FOR THE PURPOSES OF THIS INTERVIEW.

MAJOR FLOW CONTROL, CONDITION AND FILL VARIABLES *

THIS IS A REINTERVIEW R (Z076=1);

THIS IS A NEW SPOUSE/PARTNER OF A REINTERVIEW R (Z076=0);

THIS IS A NEVER INTERVIEWED R or NEW INTERVIEW R (Z076=5)

THIS IS A SELF INTERVIEW (A009=1);

THIS IS A PROXY INTERVIEW (A009={2 or 3}) or (A009 NOT 1);

PROXY REPORTER IS SURVIVING SPOUSE (A009=2);

PROXY REPORTER IS NON-SPOUSE (A009=3)

R IS MARRIED (X065=1);

R IS PARTNERED (X065=3);

R IS SINGLE (X065=6)

HRS 2012 — SECTION J: EMPLOYMENT — PAGE 2

FINAL VERSION — 11/05/2012

R HAS **SAME SPOUSE/PARTNER** AS R's LAST IW (A020=1);
R's FORMER **PARTNER IS NOW HIS/HER SPOUSE** (A020=3);
R's FORMER **SPOUSE IS NOW HIS/HER PARTNER** (A020=4)

R CURRENTLY LIVES IN A **NURSING HOME** (A028=1)

R HAS **NO OTHER RESIDENCE** OUTSIDE NURSING HOME (A070=5)

R's **LAST IW MONTH** (per Z092), **YEAR** (per Z093) = R's **LAST IW DATE**

R's **AGE** (per A019)

R WAS **WORKING FOR SOMEONE ELSE AT R's LAST IW** (Z136=1);
R WAS **SELF-EMPLOYED AT R's LAST IW** (Z136=2)

R's **LAST IW EMPLOYER NAME** (per A508)
Job Status is PW JOB (Z503=1) and Employer Name not empty (Z141 NOT Empty)

R's **LAST IW TITLE** (per Z128)

R WAS **INCLUDED IN PENSION PLAN ON JOB AT LAST IW** (Z133=1)

R WAS **DISABLED AT R's LAST IW** (Z122=1);
R WAS **WORKING FOR PAY AT R's LAST IW** (Z123=1);
R WAS **RETIRED AT R's LAST IW** (Z124=1)

R WAS **COMPLETELY RETIRED AT R's LAST IW** (Z134=1);
R WAS **PARTLY RETIRED AT R's LAST IW** (Z134=3);
R WAS **NOT RETIRED AT R's LAST IW** (Z134=5)

R's **PAST PENSION TYPE**: TYPE A: Z140=1; TYPE B: Z140=2;
BOTH TYPES, ASK A ONLY: Z140=3; BOTH TYPES, ASK B ONLY: Z140=4

ALTERNATE WAVE VARIABLE IS SET TO ASK QUESTIONS EVERY 3RD WAVE (J731_3Wave=0):
{J731 = (A504_CurrWaveNdx - 7) MOD 3} = 0};
I.e., When subtracting the Indices (per A504) for Beginning Wave (Index 7 for YrXXXX) from Current Wave (Index 7 for 2004), and the result is divided by the Wave Interval of 3, the Integer Result leaves No Remainder

ALTERNATE WAVE VARIABLE IS NOT SET TO ASK QUESTIONS (J731>0):
{J731 = {(A504_CurrWaveNdx - XX) MOD 3} > 0};
I.e., Integer Result yields a Remainder

**** IN 2012 THIS ALTERNATE WAVE FLAG IS NOT SET TO ASK QUESTIONS ****

ALTERNATE WAVE VARIABLE IS SET TO ASK QUESTIONS EVERY 4TH WAVE (J732_4Wave=0):
{J732 = (A504_CurrWaveNdx - 5) MOD 4} = 0};
I.e., When subtracting the Indices (per A504) for Beginning Wave (Index 5 for YrXXXX) from Current Wave (WaveIndex/WaveNdx 5 for 2000), and the result is divided by the Wave Interval of 4, the Integer Result leaves No Remainder

ALTERNATE WAVE VARIABLE IS NOT SET TO ASK QUESTIONS (J732>0):
{J732 = {(A504_CurrWaveNdx - XX) MOD 4} > 0};
I.e., Integer Result yields a Remainder

** IN 2012 THIS ALTERNATE WAVE FLAG IS NOT SET TO ASK QUESTIONS **

SUMMARY VARIABLES: COMPONENTS

J703: MARGINAL EMPLOYMENT IN THE CURRENT AND 2006 WAVES

- (a) IN CURRENT IW R REPORTED THAT WORKED FOR {{10 HOURS OR LESS} (J172={0-10) and {20 WEEKS OR LESS} (J179={0-20}}); and
- (b) Z206=1, WHICH IS THE FOLLOWING: IN R'S 2006 IW {R REPORTED {NOT WORKING (J020/Z123=5) or {WORKED {{10 HOURS OR LESS} (2006-J172={0-10}) and {20 WEEKS OR LESS} (2006-J179={0-20}})}}.

J703=1 MEANS THAT THE VARIABLE CONDITIONS ARE TRUE; J703=0 or J703 NOT 1 MEANS NOT TRUE.

J705: NOT WORKING CURRENTLY AND IN PAST 2 WAVES

- (a) R REPORTED IN CURRENT IW THAT {IS NOT WORKING (J020=5) and IS NOT {UNEMPLOYED or TEMPORARILY LAID OFF or ON LEAVE} (J005 {NOT 2 and NOT 3 and NOT 8})}; and
- (b) Z211=1, WHICH IS THE FOLLOWING: R REPORTED BOTH {IN 2004 and IN 2006} THAT DID NOT WORK FOR PAY (J020=5).

J705=1 MEANS THAT THE VARIABLE CONDITIONS ARE TRUE; J705 NOT 1 MEANS NOT TRUE.

* A variable fieldname and code reference is shown at its first occurrence in the questionnaire, but in some cases, especially when it is common, is not shown after that.

MONTHLIST NOTE: ELIGIBLE YEARS ARE 2011 AND 2010, THE YEARS IN WHICH THERE COULD BE IWs FOR THIS HRS WAVE, AND 2009 & 2008, THE YEARS IN WHICH THERE WERE IWs FOR Rs IN THE PREVIOUS HRS WAVE. INDIVIDUAL Rs WILL BE ASKED QUESTIONS THAT APPLY ONLY TO THE YEARS THAT SPAN THE RANGE FOR THAT R'S TWO INTERVIEWS, BEGINNING WITH THE MOST RECENT YEAR AND ENDING WITH THE YEAR OF THE PRIOR IW, OR 2008 IF THE R WAS NOT INTERVIEWED IN THE PREVIOUS HRS WAVE.

*----- Current Work Status-----

J005 BRANCHPOINT: IF THIS IS AN EXIT INTERVIEW, GO TO J023 BRANCHPOINT

J005

Now I'm going to ask you some questions about your current employment situation.

Are you working now, temporarily laid off, unemployed and looking for work, disabled and unable to work, retired, a homemaker, or what?

[IWER: DO NOT PROBE BUT CHOOSE ALL THAT APPLY]

HRS 2012 — SECTION J: EMPLOYMENT — PAGE 4

FINAL VERSION — 11/05/2012

1. WORKING NOW	2. UNEMPLOYED AND LOOKING FOR WORK	3. TEMPORARILY LAID OFF, ON SICK OR OTHER LEAVE	
4. DISABLED	5. RETIRED	6. HOMEMAKER	
7. OTHER (SPECIFY) _____	8. (VOL:) ON SICK OR OTHER LEAVE	98. DK	99. RF

J006

J007 BRANCHPOINT: IF R DID NOT REPORT THAT IS UNEMPLOYED (J005 NOT 2), GO TO J010 BRANCHPOINT

J007

In what month and year did you become unemployed?

[IWER: MONTH ENTERED MUST BE BEFORE OR IN *CURRENT IW MONTH, YEAR*]

J007

MONTH:

1. JAN	2. FEB	3. MAR	4. APR	5. MAY	6. JUN	7. JUL
8. AUG	9. SEP	10. OCT	11. NOV	12. DEC	98. DK	99. RF

DK	RF
----	----

J008

YEAR

J010 BRANCHPOINT: IF R DID NOT REPORT THAT IS {TEMPORARILY LAID OFF, ON SICK OR OTHER LEAVE} (J005 NOT 3 *and* NOT 8), GO TO J014 BRANCHPOINT

J010

Do you expect to go back to this job?

1. YES	5. NO	8. DK	9. RF
--------	-------	-------	-------

GO TO J014 BRANCHPOINT

J011

In what month and year did you last work on this job?

[IWER: MONTH ENTERED MUST BE BEFORE OR IN *CURRENT IW MONTH, YEAR*]

HRS 2012 — SECTION J: EMPLOYMENT — PAGE 5

FINAL VERSION — 11/05/2012

J011

MONTH:

1. JAN	2. FEB	3. MAR	4. APR	5. MAY	6. JUN	7. JUL
8. AUG	9. SEP	10. OCT	11. NOV	12. DEC	98. DK	99. RF

DK	RF
----	----

J012

YEAR

J014 BRANCHPOINT: IF R DID NOT REPORT THAT IS CURRENTLY DISABLED (J005 NOT 4) or IF R WAS DISABLED AT R's LAST IW (Z122=1), GO TO J017 BRANCHPOINT

J014

In what month and year did you become disabled?

[IWER: MONTH ENTERED MUST BE BEFORE OR IN *CURRENT IW MONTH, YEAR*]

J014

MONTH:

1. JAN	2. FEB	3. MAR	4. APR	5. MAY	6. JUN	7. JUL
8. AUG	9. SEP	10. OCT	11. NOV	12. DEC	98. DK	99. RF

DK	RF
----	----

J015

YEAR

J017 BRANCHPOINT: IF R DID NOT REPORT THAT IS CURRENTLY RETIRED (J005 NOT 5) or IF R WAS RETIRED AT R's LAST IW (Z124=1), GO TO J020 BRANCHPOINT

J017

In what month and year did you retire?

J017

MONTH:

1. JAN	2. FEB	3. MAR	4. APR	5. MAY	6. JUN	7. JUL
8. AUG	9. SEP	10. OCT	11. NOV	12. DEC	98. DK	99. RF

J018

YEAR

DK

RF

J020 BRANCHPOINT: IF R IS WORKING NOW (J005=1) *or* IS {TEMPORARILY LAID OFF AND EXPECTS TO GO BACK TO WORK (J010=1)}, ASSIGN 1 TO J020 AND GO TO J021

IF R CURRENTLY LIVES IN A NURSING HOME (A028=1) *and* HAS NO OTHER RESIDENCE OUTSIDE NURSING HOME (A070=5) *and* DID NOT REPORT WORKING IN R'S LAST IW (Z123 NOT 1), ASSIGN 5 TO J020 AND GO TO J023 BRANCHPOINT

J020

Are you doing any work for pay at the present time?

1. YES

5. NO

8. DK

9. RF

GO TO J023 BRANCHPOINT

J021

[On the job you plan to go back to/On your current (main) job], do you work for someone else, are you self-employed, or what?

[IWER: IF R SAYS, 'I RUN MY OWN BUSINESS' CHOOSE 'SELF-EMPLOYED']

1. SOMEONE ELSE

2. SELF-EMPLOYED

8. DK

9. RF

J023 BRANCHPOINT: IF THIS IS AN EXIT INTERVIEW *and* R WAS NOT WORKING AT R'S LAST IW (Z123 NOT 1), GO TO SECTION N

IF THIS IS AN EXIT INTERVIEW *and* R WAS NOT SELF-EMPLOYED AT LAST IW (Z136 NOT 2), GO TO J063

IF R IS CURRENTLY WORKING FOR SOMEONE ELSE (J021=1) *and* WAS WORKING FOR SOMEONE ELSE AT R'S LAST IW (Z136=1), GO TO J045

IF R DID NOT REPORT THAT IS CURRENTLY WORKING FOR SOMEONE ELSE ({J020 *and* J021} NOT 1) *and* WAS WORKING FOR SOMEONE ELSE AT R'S LAST IW (Z136=1), GO TO J063

IF R WAS SELF-EMPLOYED AT R'S LAST IW (Z136=2) *and* DID NOT REPORT THAT IS CURRENTLY SELF-EMPLOYED (J021 NOT 2), CONTINUE ON TO J023

OTHERWISE, IF EXIT IW, GO TO SECTION N

OTHERWISE, GO TO JW158_2 BRANCHPOINT

J023

According to our records, in R's LAST IW MONTH (per Z092), YEAR (per Z093) you were self-employed.

In what month and year did you stop working for yourself?

Now I have some questions about R's FIRST NAME's (X058) employment before [he/she] died. According to our records, in R's LAST IW MONTH, YEAR [he/she] was self-employed.

In what month and year did [he/she] stop working for [himself/herself]?

[IWER: MONTH ENTERED MUST BE BETWEEN R's LAST IW MONTH, YEAR AND R's DATE OF DEATH — MONTH, YEAR.]

[IWER: MONTH ENTERED MUST BE BETWEEN R's LAST IW MONTH, YEAR AND CURRENT IW MONTH, YEAR.]

J023

MONTH:

1. JAN	2. FEB	3. MAR	4. APR	5. MAY	6. JUN
--------	--------	--------	--------	--------	--------

7. JUL	8. AUG	9. SEP	10. OCT	11. NOV	12. DEC
--------	--------	--------	---------	---------	---------

94. STILL WORKING FOR SELF (AS PRIMARY JOB)
EXIT: DOES NOT DISPLAY

96. STILL WORKING FOR SELF AS SECOND JOB
EXIT: WORKED THERE UNTIL DEATH

GO BACK TO J021 AND CHANGE RESPONSE TO SELF-EMPLOYED (J021=2)

GO TO J028

97. DENIES BEING SELF-EMPLOYED AT PREVIOUS IW

98. DK

99. RF

GO TO JW158_2 BRANCHPOINT
EXIT: GO TO SECTION N

DK

RF

J024

YEAR

J028 BRANCHPOINT: IF THIS IS AN EXIT INTERVIEW, GO TO J031

IF R DID NOT REPORT THAT IS STILL WORKING FOR SELF (AS
SECOND JOB) (J023 NOT 96), GO TO J031

J028

Were there any months since [R's LAST IW MONTH, YEAR/MONTH, YEAR 2 YEARS
AGO] when you were not working for pay?

1. YES	5. NO	8. DK	9. RF
GO TO JW158_2 BRANCHPOINT			

HRS 2012 — SECTION J: EMPLOYMENT — PAGE 9

FINAL VERSION — 11/05/2012

BEGINNING OF JW777_1 LOOP: QUESTIONS JW777_1 AND JW778_1 ARE REPEATED FOR UP TO FOUR ELIGIBLE YEARS.

NOTE: ELIGIBLE YEARS ARE 2013 AND 2012, THE YEARS IN WHICH THERE COULD BE IWs FOR THIS HRS WAVE, AND 2011 & 2010, THE YEARS IN WHICH THERE WERE IWs FOR Rs IN THE PREVIOUS HRS WAVE. INDIVIDUAL Rs WILL BE ASKED QUESTIONS THAT APPLY ONLY TO THE YEARS THAT SPAN THE RANGE FOR THAT R's TWO INTERVIEWS, BEGINNING WITH THE MOST RECENT YEAR AND ENDING WITH THE YEAR OF THE PRIOR IW, OR 2010 IF THE R WAS NOT INTERVIEWED IN THE PREVIOUS HRS WAVE.

JW777_1

Were there any months in ELIGIBLE YEAR when you were not working for pay?

1. YES	5. NO	8. DK	9. RF
GO TO END OF JW777_1 LOOP			

JW778_1 BRANCHPOINT: IF THERE IS ONLY ONE ELIGIBLE MONTH ON MONTHLIST, ASSIGN THAT MONTH TO JW778_1 AND GO TO THE END OF JW777_1 LOOP

JW778_1

Which months in ELIGIBLE YEAR were those (when you were not working for pay)?

[IWER: CHOOSE ALL THAT APPLY]

[IWER: ONLY ELIGIBLE MONTHS WILL APPEAR ON THE LIST]

[IWER: YOU MUST ENTER MONTH(S) FOR THIS QUESTION. IF YOU HAVE GOTTEN THIS QUESTION IN ERROR, BACK UP AND CHANGE ANSWER TO PREVIOUS QUESTION TO 'NO']

1. JAN	2. FEB	3. MAR	4. APR	5. MAY	6. JUN	7. JUL
8. AUG	9. SEP	10. OCT	11. NOV	12. DEC	13. ALL	
14. ALL MONTHS DISPLAYED	15. ALL MONTHS DISPLAYED	98. DK	99. RF			

NOTE: THE ONLY MONTHS AND YEARS PRESENTED TO THE IWER ARE THOSE BETWEEN R's LAST IW UNTIL THE CURRENT IW DATE. CODES 13, 14, AND 15 ARE NOT SHOWN IN THE DATA AND SHOULD NOT BE USED FOR ANALYSIS PURPOSES. THEY WILL ONLY SHOW IN THE CODEFRAME AS A CONVENIENCE FOR INTERVIEWERS WHEN APPROPRIATE.

***END OF JW777_1 LOOP: QUESTIONS JW777_1 AND JW778_1 ARE REPEATED FOR UP TO FOUR ELIGIBLE YEARS. OTHERWISE, CONTINUE ON TO JW786_1 BRANCHPOINT ***

JW786_1 BRANCHPOINT: IF R's LAST IW OCCURRED IN THE PREVIOUS HRS WAVE, GO TO JW158_2 BRANCHPOINT

JW786_1

Were there any months between [R's LAST IW MONTH, YEAR/MONTH, YEAR 2 YEARS AGO] and January [FIRST YEAR OF PREVIOUS HRS WAVE DATA COLLECTION] when you were not working for pay?

1. YES	5. NO	8. DK	9. RF
--------	-------	-------	-------

J031 BRANCHPOINT: GO TO JW158_2 BRANCHPOINT

J031

Were you paid a regular salary or wages?

Was [she/he] paid a regular salary or wages?

1. YES	5. NO	8. DK	9. RF
GO TO J038			

J032

How much were you paid before taxes and other deductions?

How much was she/he paid before taxes and other deductions?

[IWER: DO NOT PROBE DK/RF]

[IWER: IF AMOUNT PER HOUR, ENTER BOTH DOLLARS AND CENTS]

AMOUNT	0	DK	RF
GO TO J036	GO TO J038		

J033-J035 Unfolding Sequence

Question text: {CORE AND EXIT} Did it amount to a total of less than \$___ per month, more than \$___ per month, or what?

PROCEDURES: 2Up1Down, 1Up2Down

BREAKPOINTS: \$625, \$1,500, \$3,000, \$6,500

RANDOM ENTRY POINTS: \$1,500, \$3,000

ENTRY POINT ASSIGNMENT: 1 OR {NOT 1} AT X510

ORDER OF ENTRY POINT ASSIGNMENTS AND PROCEDURES CORRESPOND

J036 BRANCHPOINT: GO TO J038

J036

{CORE AND EXIT} [IWER: PROBE IF NECESSARY]

Was that per hour, week, month, or year?

PER:

1. HOUR 2. WEEK 3. EVERY TWO WEEKS/BI-WEEKLY 4. MONTH 5. TWICE A MONTH

6. YEAR 7. OTHER (SPECIFY) 8. DK 9. RF

J037

J038

Did you receive some or all of the net earnings or profits?

Did [she/he] receive some or all of the net earnings or profits?

DEFINITION: NET EARNING OR PROFIT IS TOTAL BUSINESS INCOMES LESS TOTAL BUSINESS EXPENSES.

1. YES 5. NO 8. DK 9. RF

J039 BRANCHPOINT: IF R IS/WAS PAID A REGULAR SALARY (J031=1) and R DID NOT RECEIVE NET EARNINGS OR PROFITS (J038 NOT 1), GO TO J073 BRANCHPOINT

J039

IF R NOT PAID REGULAR SALARY and DID NOT RECEIVE NET EARNINGS OR PROFITS (J031 and J038 NOT 1):

What did you earn the last year you worked?

OTHERWISE:

(In addition to your regular salary,) How much did you receive from net earnings or profits?

[IWER: IF R HAS TROUBLE GIVING DOLLAR FIGURE, ASK:]

What did you earn the last year you worked?

IF R NOT PAID REGULAR SALARY and DID NOT RECEIVE NET EARNINGS OR PROFITS (J031 and J038 NOT 1):

What did [she/he] earn the last year [she/he] worked?

OTHERWISE:

(In addition to [her/his] regular salary,) How much did [she/he] receive from net earnings or profits?

[IWER: IF PROXY HAS TROUBLE GIVING DOLLAR FIGURE, ASK:]

What did [she/he] earn the last year [she/he] worked?

DEFINITION: NET EARNING OR PROFIT IS TOTAL BUSINESS INCOMES LESS TOTAL BUSINESS EXPENSES.

[IWER: DO NOT PROBE DK/RF]

[IWER: AMOUNT PER HOUR, ENTER BOTH DOLLARS AND CENTS]

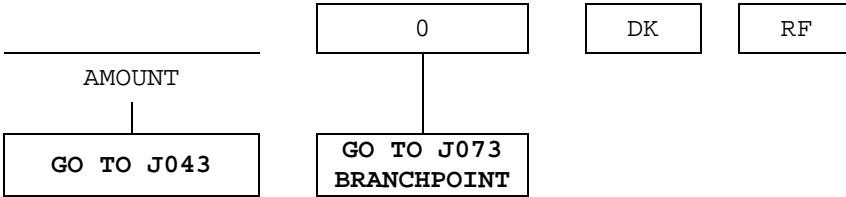

J040-J042 Unfolding Sequence {CORE AND EXIT}

Question text: Did it amount to a total of less than \$____ per year, more than \$____ per year, or what?

PROCEDURES: 2Up1Down, 1Up2Down

BREAKPOINTS: \$3,300, \$10,000, \$30,000, \$75,000

RANDOM ENTRY POINTS: \$10,000, \$30,000

ENTRY POINT ASSIGNMENT: 1 OR {NOT 1} AT X501

ORDER OF ENTRY POINT ASSIGNMENTS AND PROCEDURES CORRESPOND

J043 BRANCHPOINT: GO TO J073 BRANCHPOINT

J043

{CORE AND EXIT} [IWER: PROBE IF NECESSARY]

Was that per hour, week, month, or year?

PER:

1. HOUR	2. WEEK	3. EVERY TWO WEEKS/BI-WEEKLY	4. MONTH	5. TWICE A MONTH
6. YEAR	7. OTHER (SPECIFY) _____ J044	8. DK	9. RF	

J045 BRANCHPOINT: GO TO J073 BRANCHPOINT

J045

According to our records, in R's LAST IW MONTH, YEAR you were [working for R's LAST IW EMPLOYER NAME (per A508)/also working for someone else].

Are you still working [there/for that same employer]?

[IWER: IF NO PREVIOUS WAVE EMPLOYER NAME APPEARS AND R HAD MORE THAN ONE JOB, WE ARE INTERESTED IN RS MAIN JOB.]

[IWER: IF THERE HAS BEEN MERGER AND ACQUISITION USE CODE 3 OR 4]

1. YES	3. YES, BUT OWNERSHIP HAS CHANGED (VOL)	4. NO, OWNERSHIP (VOL)	5. NO
--------	---	------------------------	-------

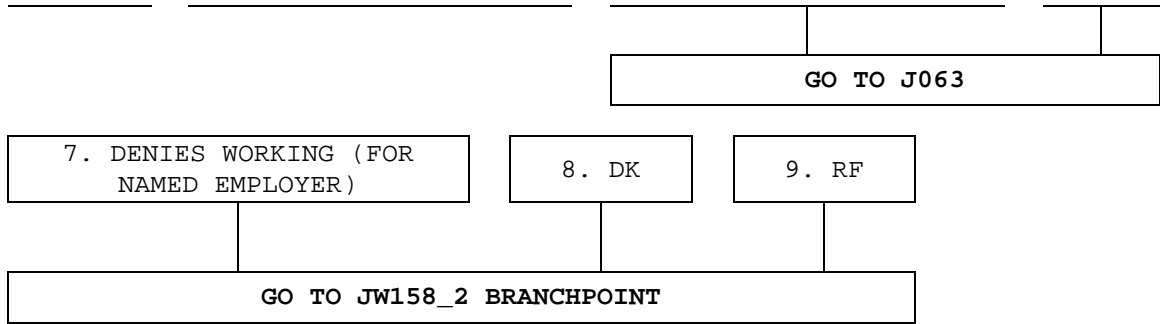

*-----BEGINNING OF EMPLOYER INFORMATION BLOCK-1: PAST EMPLOYER-----
 (JW168_1 — JW165_1)

THE FOLLOWING SERIES OF EMPLOYER NAME AND ADDRESS QUESTIONS (JW168_1 THROUGH JW165_1) IS REPLICATED FURTHER ON IN SECTION J (JW158_2 - JW165_2) AND ALSO IN SECTION K (KW158_3 - KW165_3) AND SECTION L (LW158_4 - LW165_4) AND IS KNOWN AS THE SECTION J EMPLOYER NAME BLOCK. QUESTION NUMBERS WITHIN THE EMPLOYER NAME BLOCK ARE W158 - W165, PRECEDED BY THE SECTION NAME, J, AND FOLLOWED BY "_1" WHICH INDICATES THAT THIS IS THE FIRST TIME THE EMPLOYER NAME BLOCK HAS OCCURRED WITHIN THE QUESTIONNAIRE. QUESTION JW168 OCCURS ONLY IN THIS FIRST OCCURRENCE OF THE EMPLOYER INFORMATION BLOCK, BELOW.

JW168_1 BRANCHPOINT: IF WE DO NOT KNOW EMPLOYER NAME FROM R'S LAST IW (A508=EMPTY), GO TO JW158_1

JW168_1

Is the correct name of your employer R'S LAST IW EMPLOYER NAME?

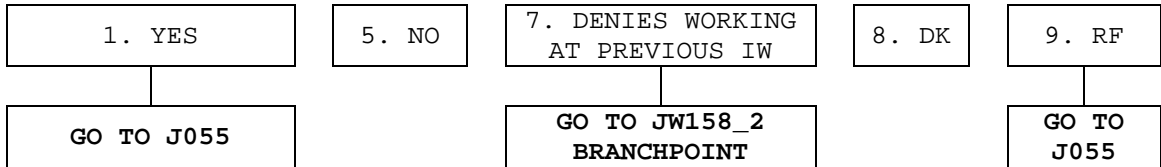

JW158_1

IWER: READ TO ALL RESPONDENTS:

We would like to obtain complete information about fringe benefits for employees like you. In order to do this, we need the full name and address of your employer.

For whom do you work [now/on your main job]?
 What is the (company's/organization's) name?

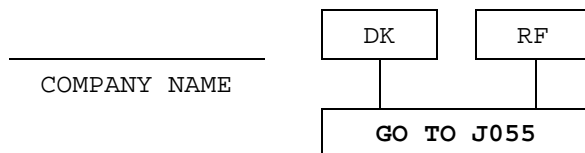

HRS 2012 — SECTION J: EMPLOYMENT — PAGE 14

FINAL VERSION — 11/05/2012

JW159_1

IF R WORKS FOR SAME EMPLOYER AS R'S LAST IW (J045={1 or 3}) and WE KNOW EMPLOYER NAME FROM LAST IW (A508 NOT EMPTY):

We would like to obtain complete information about fringe benefits for employees like you. In order to do this, we need the full address of your employer.

ASK ALL Rs:

What is the address of the place where you work?

[IWER: PROBE IF NECESSARY]

I will need the mailing address, city, state, and zip code.

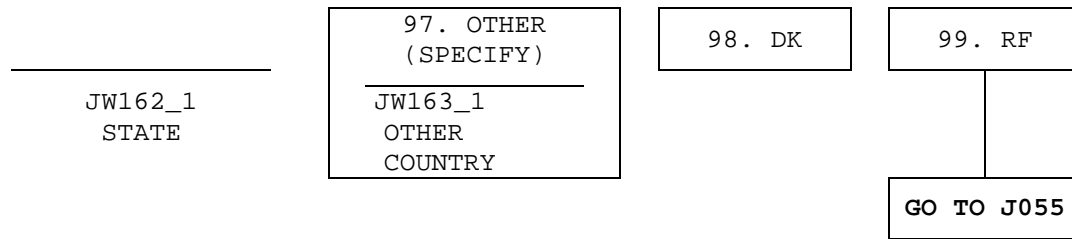
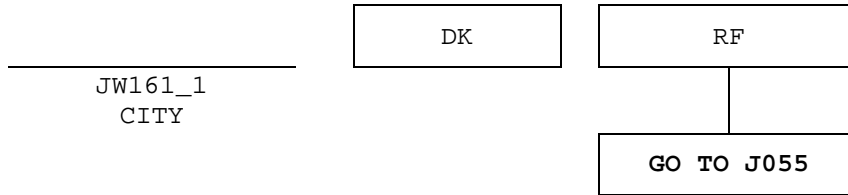
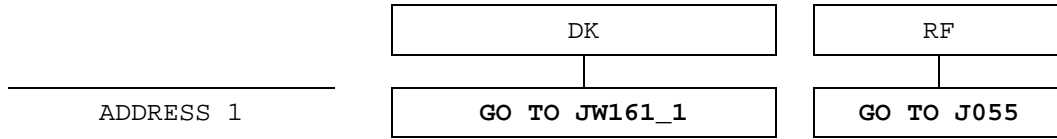

NOTE: THE IWER TYPES THE FIRST LETTER IN, THEN SELECTS FROM A MENU OF STATE NAMES, INCLUDING WASHINGTON, D.C., AND PUERTO RICO.

JW778_2 BRANCHPOINT: IF THERE IS ONLY ONE ELIGIBLE MONTH ON MONTHLIST, ASSIGN THAT MONTH TO JW778_2 AND GO TO THE END OF JW777_2 LOOP

JW778_2

Which months in ELIGIBLE YEAR were those (when you did not work for [R's LAST IW EMPLOYER NAME (per A508)/R's CURRENT EMPLOYER NAME (per J045 or JW158_1)/that employer])?

[IWER: CHOOSE ALL THAT APPLY]

[IWER: ONLY ELIGIBLE MONTHS WILL APPEAR ON THE LIST]

[IWER: YOU MUST ENTER MONTH(S) FOR THIS QUESTION. IF YOU HAVE GOTTEN THIS QUESTION IN ERROR, BACK UP AND CHANGE ANSWER TO PREVIOUS QUESTION TO 'NO']

1. JAN	2. FEB	3. MAR	4. APR	5. MAY	6. JUN	7. JUL
8. AUG	9. SEP	10. OCT	11. NOV	12. DEC	13. ALL	
14. ALL MONTHS DISPLAYED		15. ALL MONTHS DISPLAYED		98. DK	99. RF	

NOTE: THE ONLY MONTHS AND YEARS PRESENTED TO THE IWER ARE THOSE BETWEEN R's LAST IW UNTIL THE CURRENT IW DATE. CODES 13, 14, AND 15 ARE NOT SHOWN IN THE DATA AND SHOULD NOT BE USED FOR ANALYSIS PURPOSES. THEY WILL ONLY SHOW IN THE CODEFRAME AS A CONVENIENCE FOR INTERVIEWERS WHEN APPROPRIATE.

***END OF JW777_2 LOOP: QUESTIONS JW777_2 AND JW778_2 ARE REPEATED FOR UP TO FOUR ELIGIBLE YEARS. OTHERWISE, CONTINUE ON TO JW786_2 BRANCHPOINT ***

JW786_2 BRANCHPOINT: IF R's LAST IW OCCURRED IN THE PREVIOUS HRS WAVE, GO TO J058

JW786_2

Were there any months between [R's LAST IW MONTH, YEAR/MONTH, YEAR 2 YEARS AGO] and January [FIRST YEAR OF PREVIOUS HRS WAVE DATA COLLECTION] when you did not work for [R's LAST IW EMPLOYER NAME (per A508)/R's CURRENT EMPLOYER NAME (per J045 or JW158_1)/that employer]?

J058

IF WE DO NOT HAVE JOB TITLE FROM R's LAST IW (Z128=EMPTY):
Is your job title still the same as it was in R's LAST IW MONTH, YEAR?

OTHERWISE:

HRS 2012 — SECTION J: EMPLOYMENT — PAGE 17

FINAL VERSION — 11/05/2012

In *R's LAST IW MONTH, YEAR* our records indicate that your job title was *R's LAST IW TITLE (per Z128)*.

Is this still the case?

[IWER: IF JOB TITLE IS SLIGHTLY INACCURATE BUT DESCRIBES R's CURRENT JOB, ANSWER 'YES' HERE AND NOTE CORRECTIONS AS A COMMENT.]

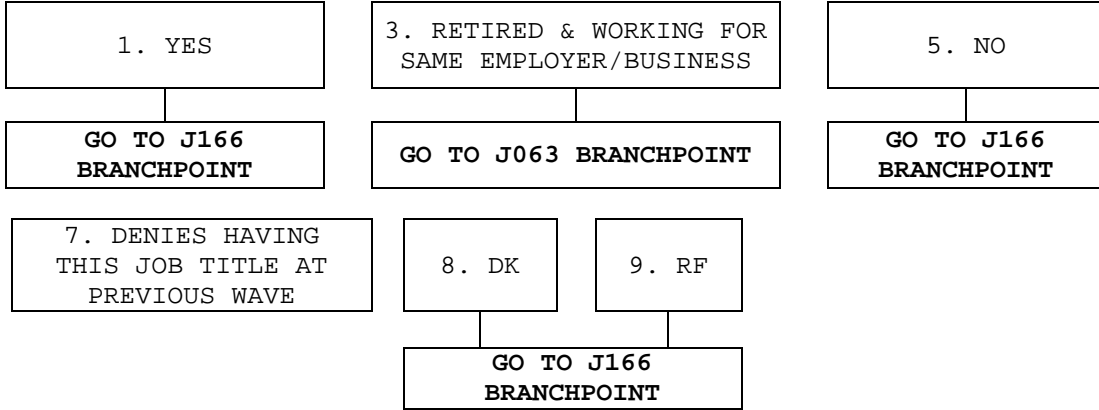

J059

What was your job title in [*R's LAST IW MONTH, YEAR*]?

[IWER: PROBE:]

The title that your employer used?

TITLE

DK RF

J060

What sort of work did you do?

[IWER: PROBE:]

Tell me a little more about what you did.

_____ DK RF

J061

What is your job title now?

[IWER: PROBE:]

The title that your employer uses?

_____ DK RF
TITLE

J062

What sort of work do you do now?

[IWER: PROBE:]

Tell me a little more about what you do.

_____ DK RF

J063 BRANCHPOINT: IF R DENIES HAVING PREVIOUSLY LISTED JOB TITLE AT R's LAST IW (J058=7), GO TO J169

IF R REPORTED {IS RETIRED AND WORKING FOR SAME EMPLOYER} (J058=3) and GAVE YEAR S/HE RETIRED AT J018, GO TO J067 BRANCHPOINT

J063

IF R {WAS WORKING IN LAST IW AND NOW IS {RETIRED AND WORKING FOR SAME EMPLOYER/BUSINESS}} (J058=3) and YEAR RETIRED WAS NOT REPORTED (J018 NOT ASKED):

In what month and year did you retire?

IF R IS NO LONGER WORKING FOR R's LAST IW EMPLOYER (J045={4 or 5}):

In what month and year did you stop working [for R's LAST IW EMPLOYER NAME /there]?

IF NAME OF R's LAST IW EMPLOYER IS KNOWN (A508 NOT EMPTY):

According to our records, you were working for R's LAST IW EMPLOYER NAME (per A508) in R's LAST IW MONTH, YEAR.

In what month and year did you stop working there?

OTHERWISE:

According to our records, you were working for someone else when we last talked to you in R's LAST IW MONTH, YEAR.

In what month and year did you stop working for that employer?

[IWER: MONTH ENTERED MUST BE BETWEEN R's LAST IW MONTH, YEAR AND CURRENT IW MONTH, YEAR]

Now I have some questions about R's FIRST NAME's employment before [he/she] died.

IF R'S LAST IW EMPLOYER IS KNOWN (A508 NOT EMPTY):

According to our records, [he/she] was working for R's LAST IW EMPLOYER NAME (per A508) in R's LAST IW MONTH, YEAR.

In what month and year did [he/she] stop working there, or was [he/she] still working there when [he/she] died?

OTHERWISE:

According to our records, [he/she] was working for someone else when we last talked to [him/her] in R's LAST IW MONTH, YEAR.

In what month and year did [he/she] stop working for that employer?

[IWER: MONTH ENTERED MUST BE BETWEEN R's LAST IW MONTH, YEAR AND R's DATE OF DEATH, MONTH, YEAR.]

J063

MONTH:

- | | | | | | |
|--------|--------|--------|---------|---------|---------|
| 1. JAN | 2. FEB | 3. MAR | 4. APR | 5. MAY | 6. JUN |
| 7. JUL | 8. AUG | 9. SEP | 10. OCT | 11. NOV | 12. DEC |

92. DENY WORKING FOR SELF
 EXIT: DOES NOT DISPLAY

93. STILL WORKING FOR SELF AS SECOND JOB
 EXIT: DOES NOT DISPLAY

94. STILL WORKING FOR SELF (AS PRIMARY JOB)
 EXIT: DOES NOT DISPLAY

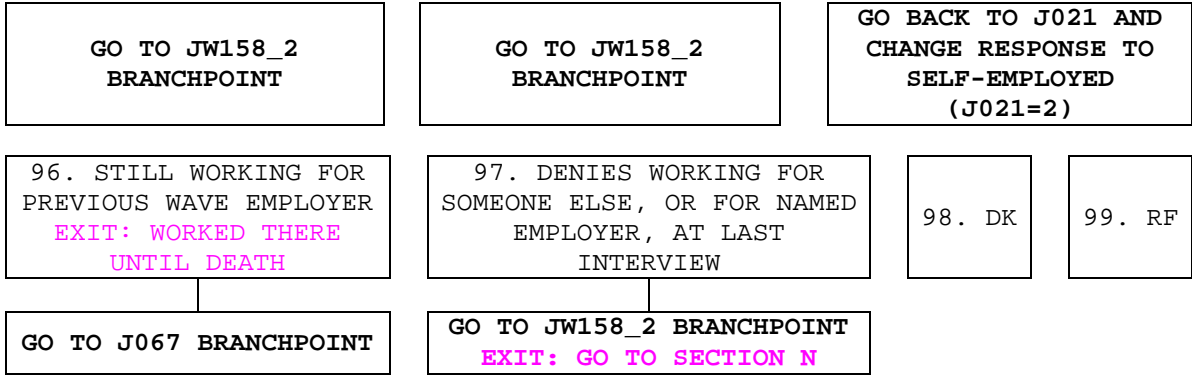

NOTE: WHEN R REPORTED EARLIER THAT WAS RETIRED AND WORKING FOR THE SAME EMPLOYER (J058=3), CODE "96. STILL WORKING FOR PREVIOUS WAVE EMPLOYER" DOES NOT APPEAR IN THIS CODEFRAME.

J064

YEAR

DK	RF
----	----

J067 BRANCHPOINT: IF R IS SELF-EMPLOYED (J021=2) and SAID THAT IS STILL WORKING FOR PREVIOUS WAVE EMPLOYER (J063=96), GO BACK TO J021 AND CHANGE RESPONSE TO SOMEONE ELSE (J021=1)

IF R IS SELF-EMPLOYED (J021=2) and SAID THAT IS STILL WORKING FOR SELF AS PRIMARY JOB (J063=94), GO TO J166 BRANCHPOINT

IF R SAID STILL WORKING FOR LAST IW EMPLOYER (J063=96) and DID NOT REPORT THAT IS {RETIRED AND WORKING FOR SAME EMPLOYER/BUSINESS} (J058 NOT 3) and R WAS ASKED J045 (J045 NOT EMPTY), GO BACK TO J045 AND CHANGE RESPONSE TO YES (J045=1)

J067

IF R WAS WORKING IN LAST IW (Z123=1) and NOW IS {RETIRED AND WORKING FOR SAME EMPLOYER/BUSINESS (J058=3)}:

What were you earning, before deductions, when you retired?

OTHERWISE:

What were you earning, before deductions, when you left that employer?

What was [he/she] earning, before deductions, [when [he/she] left that employer/at the time of [his/her] death]?

[IWER: IF AMOUNT PER HOUR, ENTER BOTH DOLLARS AND CENTS]

[IWER: DO NOT PROBE DK/RF]

0	DK	RF
---	----	----

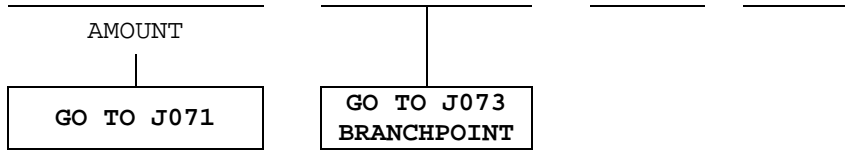

J068-J070 Unfolding Sequence {CORE AND EXIT}

Question text: Did it amount to a total of less than \$____ per month, more than \$____ per month, or what?

PROCEDURES: 2Up1Down, 1Up2Down
 BREAKPOINTS: \$200, \$800, \$1,500, \$3,000
 RANDOM ENTRY POINTS: \$800, \$1,500
 ENTRY POINT ASSIGNMENT: 1 OR {NOT 1} AT X502
 ORDER OF ENTRY POINT ASSIGNMENTS AND PROCEDURES CORRESPOND

J071 BRANCHPOINT: GO TO J073 BRANCHPOINT

J071
 {CORE AND EXIT} [IWER: PROBE IF NECESSARY]
 Was that per hour, week, month, or year?
 PER:

- | | | | | |
|---------|-----------------------------|------------------------------|----------|------------------|
| 1. HOUR | 2. WEEK | 3. EVERY TWO WEEKS/BI-WEEKLY | 4. MONTH | 5. TWICE A MONTH |
| 6. YEAR | 7. OTHER (SPECIFY)
_____ | | 8. DK | 9. RF |

J073 BRANCHPOINT: IF R IS {RETIRED AND WORKING FOR SAME EMPLOYER/BUSINESS} (J058=3), GO TO JW158_2 BRANCHPOINT

 IF THIS IS AN EXIT INTERVIEW, GO TO J084 BRANCHPOINT

J073
 IF NOT SELF-EMPLOYED AT LAST IW (Z136=1):
 Why did you leave that employer?

(Did the business close, were you laid off or let go, did you have poor health or a disability, did you leave to take care of family members, did you quit, did you retire, did ownership of your employment change, did your pension rules change, or what?)

IF SELF-EMPLOYED AT LAST IW (Z136=2):
 Why did you stop working at that business?

[IWER: DO NOT PROBE BUT CHOOSE ALL THAT APPLY]

- | | | | | |
|--------------------|--------------------|-------------------------|----------------|---------------|
| 1. BUSINESS CLOSED | 2. LAID OFF/LET GO | 3. POOR HEALTH/DISABLED | 4. FAMILY CARE | 5. BETTER JOB |
|--------------------|--------------------|-------------------------|----------------|---------------|

HRS 2012 — SECTION J: EMPLOYMENT — PAGE 22

FINAL VERSION — 11/05/2012

GO TO J080
BRANCHPOINT

GO TO J079

6. QUIT

7. RETIRED

9. OWNERSHIP
CHANGED

10. PENSION RULES CHANGED

97. OTHER (SPECIFY)

J074

98. DK

99. RF

J075 BRANCHPOINT: IF R WAS SELF-EMPLOYED AT R'S LAST IW (Z136=2), GO TO J080
BRANCHPOINT

J075

Did your employment situation change in some way that encouraged you to leave?

1. YES

5. NO

8. DK

9. RF

GO TO J078

J076

How did it change?

[IWER: CHOOSE ALL THAT APPLY]

1. SUPERVISOR
ENCOURAGED
DEPARTURE

2. COWORKER
ENCOURAGED
DEPARTURE

3. WAGES
REDUCED (OR
ABOUT TO BE
REDUCED)

4. HOURS REDUCED
(OR ABOUT TO BE
REDUCED)

GO TO J079

5. WOULD HAVE
BEEN LAID OFF

6. NEW JOB
DUTIES

7. NEW JOB
LOCATION

8. BECAME ELIGIBLE
FOR PENSION

9. EMPLOYER CHANGED HEALTH
INSURANCE

10. SPECIAL EARLY RETIREMENT
INCENTIVE OFFER

97. OTHER (SPECIFY)

J077

98. DK

99. RF

J078

If your employer had allowed you to work fewer hours with correspondingly less pay, would you have continued working there?

1. YES	5. NO	8. DK	9. RF
--------	-------	-------	-------

J079

Did your employer experience a permanent reduction in employment between [R's LAST IW MONTH, YEAR/YEAR 2 YEARS AGO] and the time you were leaving?

[IWER: PERMANENT EMPLOYMENT REDUCTIONS ARE SOMETIMES CALLED 'DOWNSIZING'; 'LAYOFFS' CAN BE PERMANENT OR TEMPORARY.]

1. YES	5. NO	8. DK	9. RF
--------	-------	-------	-------

J080 BRANCHPOINT: IF R STOPPED WORKING FOR {LAST IW EMPLOYER or SELF} {ONE MONTH OR LESS} AFTER R's LAST IW (per {J063&J064 or J023&J024 or J017&J018}) or R DID NOT SAY WHEN S/HE STOPPED WORKING FOR {LAST IW EMPLOYER or SELF} ({J063 or J064}={DK or RF} or {{J023 or J024} or {J017 or J018}}={DK or RF}), GO TO J084 BRANCHPOINT

NOTE: If date R stopped working for PW Employer is known (per J063&J064 or J023&J024 or J017&J018) and date is at least 2 months after R's last iw, continue on to J080

J080

Were there any months between R's LAST IW MONTH, YEAR and MONTH, YEAR R [STOPPED WORKING FOR [EMPLOYER (per J063&J064)/SELF (per J023&J024)] /RETIRED {per J017&J018}] when you did not work [for R's LAST IW EMPLOYER NAME (per A508)/ at this business/for this employer]?

1. YES	5. NO	8. DK	9. RF
GO TO JW158_2 BRANCHPOINT			

BEGINNING OF JW777_3 LOOP: QUESTIONS JW777_3 AND JW778_3 ARE REPEATED FOR UP TO FOUR ELIGIBLE YEARS.

NOTE: ELIGIBLE YEARS ARE 2013 AND 2012, THE YEARS IN WHICH THERE COULD BE IWS FOR THIS HRS WAVE, AND 2011 & 2010, THE YEARS IN WHICH THERE WERE IWS FOR Rs IN THE PREVIOUS HRS WAVE. INDIVIDUAL Rs WILL BE ASKED QUESTIONS THAT APPLY ONLY TO THE YEARS THAT SPAN THE RANGE FOR THAT R's TWO INTERVIEWS, BEGINNING WITH THE MOST RECENT YEAR AND ENDING WITH THE YEAR OF THE PRIOR IW, OR 2010 IF THE R WAS NOT INTERVIEWED IN THE PREVIOUS HRS WAVE.

JW777_3 BRANCHPOINT: IF WE DON'T KNOW YEAR R [STOPPED WORKING FOR EMPLOYER/SELF/RETIRED] (J064 or J024 and J018= DK or RF), GO TO JW158_2 BRANCHPOINT

IF R's LAST IW YEAR (Z093) and YEAR R [STOPPED WORKING FOR EMPLOYER/SELF/RETIRED] (per J064/J024) ARE NOT IN ELIGIBLE YEAR RANGE (per J064/J024/J018), GO TO JW158_2 BRANCHPOINT

IF R's LAST IW YEAR (Z093) and YEAR R [STOPPED WORKING FOR EMPLOYER/SELF/RETIRED] (per J064/J024/J018) ARE THE SAME, GO TO JW778_3

JW777_3

Were there any months in *ELIGIBLE YEAR* when you did not work [at this business/for this employer]?

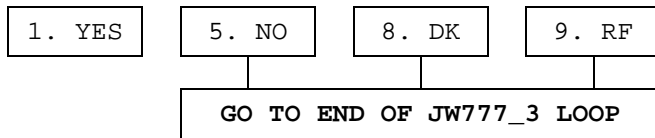

JW778_3 BRANCHPOINT: IF THERE IS ONLY ONE ELIGIBLE MONTH ON MONTHLIST, ASSIGN THAT MONTH TO JW778_3 AND GO TO THE END OF JW777_3 LOOP

JW778_3

Which months in *ELIGIBLE YEAR* were those (when you did not work [at this business/for this employer])?

[IWER: CHOOSE ALL THAT APPLY]

[IWER: ONLY ELIGIBLE MONTHS WILL APPEAR ON THE LIST]

[IWER: YOU MUST ENTER MONTH(S) FOR THIS QUESTION. IF YOU HAVE GOTTEN THIS QUESTION IN ERROR, BACK UP AND CHANGE ANSWER TO PREVIOUS QUESTION TO 'NO']

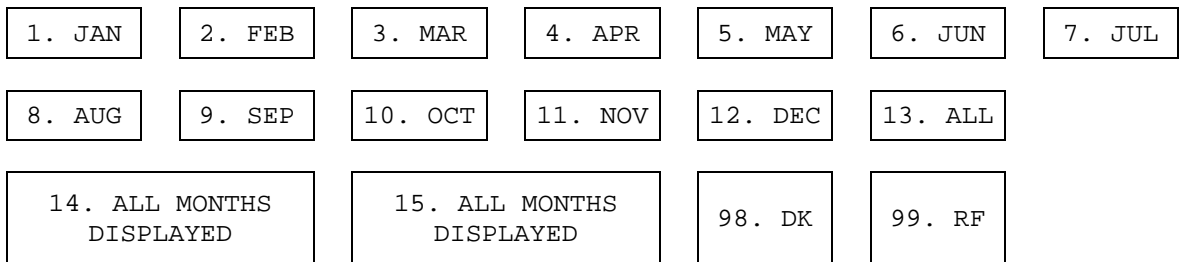

NOTE: THE ONLY MONTHS AND YEARS PRESENTED TO THE IWER ARE THOSE FROM R'S LAST IW UNTIL THE DATE R STOPPED WORKING FOR THAT EMPLOYER/BUSINESS. CODES 13, 14, AND 15 ARE NOT SHOWN IN THE DATA AND SHOULD NOT BE USED FOR ANALYSIS PURPOSES. THEY WILL ONLY SHOW IN THE CODEFRAME AS A CONVENIENCE FOR INTERVIEWERS WHEN APPROPRIATE.

***END OF JW777_3 LOOP: QUESTIONS JW777_3 AND JW778_3 ARE REPEATED FOR UP TO FOUR ELIGIBLE YEARS. OTHERWISE, CONTINUE ON TO JW786_3 BRANCHPOINT ***

JW786_3 BRANCHPOINT: IF THIS IS A NEW R or R's LAST IW OCCURRED IN THE PREVIOUS HRS WAVE, GO TO JW158_2 BRANCHPOINT

JW786_3

Were there any months between R's LAST IW MONTH, YEAR and January [FIRST YEAR OF PREVIOUS HRS WAVE DATA COLLECTION] when you did not work [at this business/for this employer]?

- 1. YES
- 5. NO
- 8. DK
- 9. RF

JW158_2 BRANCHPOINT: IF R IS {RETIRED AND WORKING FOR SAME EMPLOYER/BUSINESS} (J058=3), GO TO J166 BRANCHPOINT

IF R IS IN NURSING HOME (A028=1) and HAS NO OTHER RESIDENCE OUTSIDE NURSING HOME (A070=5) and DID NOT REPORT THAT IS CURRENTLY WORKING (J020 NOT 1), GO TO J478

IF R DID NOT REPORT THAT IS CURRENTLY WORKING (J020 NOT 1), GO TO J478

IF IS CURRENTLY SELF-EMPLOYED (J021=2), GO TO J166 BRANCHPOINT

*-----Currently Employed-----

*-----BEGINNING OF EMPLOYER INFORMATION BLOCK-2: CURRENT EMPLOYER-----
(JW158_2 — JW165_2)

NOTE: THE FOLLOWING SERIES OF EMPLOYER NAME AND ADDRESS QUESTIONS (JW158_2 THROUGH J165_2) IS A REPLICATE OF AN EARLIER SERIES IN SECTION J (JW158_1 -J053) AND IS KNOWN AS THE SECTION J EMPLOYER NAME BLOCK.

JW158_2

IWER: READ TO ALL RESPONDENTS:

We would like to obtain complete information about fringe benefits for employees like you. In order to do this, we need the full name and address of your employer.

For whom do you work [now/on your main job]?

What is the (company's/organization's) name?

COMPANY

DK

RF

GO TO J166
BRANCHPOINT

JW159_2

What is the address of the place where you work?

[IWER: PROBE IF NECESSARY]

I will need the mailing address, city, state, and zip code.

	DK	RF
ADDRESS 1	GO TO J161_2	GO TO J166 BRANCHPOINT
	DK	RF
JW160_2 ADDRESS		
	DK	RF
JW161_2 CITY		GO TO J166 BRANCHPOINT
	97. OTHER (SPECIFY) JW163_2 OTHER COUNTRY	98. DK
JW162_2 STATE		99. RF
		GO TO J166 BRANCHPOINT

NOTE: THE IWER TYPES THE FIRST LETTER IN, THEN SELECTS FROM A MENU OF STATE NAMES, INCLUDING WASHINGTON, D.C., AND PUERTO RICO.

	DK	RF
JW164_2 ZIP		

[IWER: DO NOT USE DASH IN PHONE NUMBER]

[IWER: ENTER 999 FOR UNKNOWN AREA CODE OR NUMBER]

	DK	RF
JW165_2 PHONE NUMBER		

-----END OF EMPLOYER INFORMATION BLOCK-2-----
(JW158_2 — JW165_2)

J166 BRANCHPOINT: IF R DID NOT REPORT THAT HAS SAME EMPLOYER AS AT LAST IW
(J045 NOT {1 or 3}), CONTINUE ON TO J166

IF THE ALTERNATE WAVE FLAG IS NOT SET TO ASK QUESTIONS
(J732>0), GO TO J167 BRANCHPOINT

*-----Current Employment Details-----
(J166-J247)

NOTE: QUESTIONS J166 THROUGH J170 ARE ALWAYS ASKED OF NEW INTERVIEW Rs. ANY REINTERVIEW R WHO CHANGED HIS/HER EMPLOYER SINCE R's LAST IW, OR FOR WHOM IT IS UNCERTAIN, (J045 NOT {1 or 3}) IS ASKED THIS SERIES, WHILE ONE WHO CHANGED A JOB TITLE, OR IT IS UNCERTAIN, (J058 {NOT 1 or NOT 3}) IS ASKED ALL BUT J166.

IN ADDITION, ALL OTHER REINTERVIEW Rs WHO WORK FOR THE SAME EMPLOYER AS AT R's LAST IW WERE LAST ASKED THIS SERIES IN 2008, AND WILL BE ASKED THIS SERIES EVERY 4TH WAVE THEREAFTER (E.G., IN 2016). THESE Rs WILL NOT BE ASKED IN 2012.

J166

IF NOT SELF-EMPLOYED (J021 NOT 2):

What kind of business or industry do you work in — that is, what do they make or do at the place where you work?

IF SELF-EMPLOYED (J021=2):

Now I have a few questions about your current business.

What industry do you work in? That is, what does your company do or make?

(What industry do you typically work in?)

DK

RF

INDUSTRY

J167 BRANCHPOINT: IF R IS CURRENTLY SELF-EMPLOYED (J021=2), GO TO J168

IF R {DID NOT REPORT THAT HAS SAME JOB TITLE *and* DID NOT REPORT THAT IS RETIRED AND WORKING FOR SAME EMPLOYER} AS AT LAST IW (J058={NOT 1 *and* NOT 3}), CONTINUE ON TO J167

IF THE ALTERNATE WAVE FLAG IS NOT SET TO ASK QUESTIONS
(J732>0), GO TO J172

J167

What is the official title of your job?

(The title that your employer uses.)

_____ DK RF

TITLE

J168

What sort of work do you do?

(Tell me a little more about what you do.)

_____ DK RF

TYPE OF WORK

J169

In what month and year did you start doing this kind of work. Please include work for previous employers?

[IWER: MONTH ENTERED MUST BE BEFORE OR IN *CURRENT IW MONTH, YEAR*]

J169

MONTH:

1. JAN	2. FEB	3. MAR	4. APR	5. MAY	6. JUN	7. JUL
8. AUG	9. SEP	10. OCT	11. NOV	12. DEC	98. DK	99. RF

_____ DK RF

J170

YEAR

J172

How many hours a week do you usually work [on this job/in this business]?

_____ DK RF

HOURS

GO TO J176

J173 BRANCHPOINT: IF R IS CURRENTLY SELF-EMPLOYED (J021=2), GO TO J179

J173

Do you work [the same/this] number of hours nearly every week, or do the hours you work vary a lot from week to week?

IF VARIATION IS DUE TO NOT WORKING AT ALL IN SOME WEEKS, PROBE:
These questions are about times when you are working.

1. SAME EACH WEEK/THIS NUMBER	2. VARY A LOT	8. DK	9. RF
GO TO J176		GO TO J176	

J174

How many hours would you work in a week with relatively long hours?

HOURS

DK	RF
----	----

J175

How many hours in a relatively short week?

HOURS

DK	RF
----	----

J176

How many weeks of paid vacation do you get each year?

[IWER: ENTER 996 IF R MENTIONS THAT SICK AND VACATION TIME ARE COMBINED]

AMOUNT	0	996	DK	RF
GO TO J177	ASSIGN 6 TO J177 AND GO TO J179		GO TO J179	

J951

(How many weeks of paid time off do you get each year?)

	0	DK	RF
AMOUNT			
	ASSIGN 6 TO J952 AND GO TO J179	GO TO J179	

J952

PER TIME UNIT:

1. DAYS	2. WEEKS	4. MONTHS	6. NONE
7. OTHER (SPECIFY) _____		8. DK	9. RF
J953			

J177 BRANCHPOINT: GO TO J179

J177

PER TIME UNIT:

1. DAYS	2. WEEKS	4. MONTHS	6. NONE
7. OTHER (SPECIFY) _____		8. DK	9. RF
J178			

J179

READ SLOWLY:

IF R {HAD ZERO WEEKS OF VACATION and WAS ASKED} (J167={0 and NOT EMPTY):
How many weeks a year do you usually work on this job?

OTHERWISE:

Counting paid vacations as weeks of work, how many weeks a year do you usually work on this job?

[IWER: COUNT PAID SICK TIME AS WORK TIME]

[IWER: THIS REFERS TO USUAL WEEKS OF WORK ON R'S CURRENT MAIN JOB]

	DK	RF
WEEKS		

J180 BRANCHPOINT: IF R {REPORTED IN CURRENT IW THAT HAS MARGINAL EMPLOYMENT and REPORTED IN LAST IW THAT HAD {MARGINAL EMPLOYMENT OR NONE}} (J703=1), GO TO J183 BRANCHPOINT

NOTE: J703, MARGINAL EMPLOYMENT IN THE CURRENT AND 2006 WAVES, IS A SUMMARY VARIABLE COMPOSED OF THE FOLLOWING CONDITIONS:

- (a) IN CURRENT IW R REPORTED THAT WORKED FOR {{10 HOURS OR LESS} (J172={0-10}) and {20 WEEKS OR LESS} (J179={0-20})}; and
- (b) Z206=1, WHICH IS THE FOLLOWING: IN R'S 2006 IW {R REPORTED {NOT WORKING (J020/Z123=5) or {WORKED {{10 HOURS OR LESS} (2006-J172={0-10}) and {20 WEEKS OR LESS} (2006-J179={0-20})}}}}.

J703=1 MEANS THAT THE VARIABLE CONDITIONS ARE TRUE.

J180

In the last 12 months, did you miss any days from work because of your health?

1. YES	5. NO	8. DK	9. RF
GO TO J183 BRANCHPOINT			

J181

About how many days did you miss?

DK	RF
----	----

DAYS

J183 BRANCHPOINT: IF R IS CURRENTLY SELF-EMPLOYED (J021=2), GO TO J187

IF R {REPORTED IN CURRENT IW THAT HAS MARGINAL EMPLOYMENT and REPORTED IN LAST IW THAT HAD {MARGINAL EMPLOYMENT OR NONE}} (J703=1), GO TO J205

IF SICK AND VACATION TIME ARE COMBINED (J176=996), GO TO J184

IF R DID NOT REPORT THAT HAS SAME EMPLOYER AS AT LAST IW (J045 NOT {1 or 3}) or R {DID NOT REPORT THAT HAS SAME JOB TITLE and DID NOT REPORT THAT IS RETIRED AND WORKING FOR SAME EMPLOYER} AS AT LAST IW (J058={NOT 1 and NOT 3}), CONTINUE ON TO J183

IF THE ALTERNATE WAVE FLAG IS NOT SET TO ASK QUESTIONS (J732>0), GO TO J205

NOTE: QUESTIONS J183 THROUGH J186 ARE ALWAYS ASKED OF NEW INTERVIEW Rs. ANY REINTERVIEW R WHO CHANGED HIS/HER EMPLOYER OR JOB TITLE SINCE R'S LAST IW, OR FOR WHOM IT IS UNCERTAIN, ({J045 NOT {1 or 3}) or {J058 {NOT 1 and NOT 3}}) IS ALSO ASKED THIS SERIES.

IN ADDITION, ALL OTHER REINTERVIEW Rs WHO WORK FOR THE SAME EMPLOYER AS AT R'S LAST IW WERE LAST ASKED THIS SERIES IN 2008, AND WILL BE ASKED THIS SERIES EVERY 4TH WAVE THEREAFTER (E.G., IN 2016). THESE Rs WILL NOT BE ASKED IN 2012.

J183

How many days of paid sick leave at full pay do you earn each year?

[IWER: IF R SAYS SICK LEAVE IS ACCRUED IN HOURS, PROBE: HOW MANY DAYS PER YEAR WOULD THAT BE? IF LESS THAN 1 DAY PER YEAR, ENTER '0']

_____ 995 NO SET NUMBER DK RF

DAYS

J184

Does your employer provide coverage for long-term disability on this job?

1. YES 5. NO 8. DK 9. RF

J185

On your job, do you make decisions about the pay and promotion of others?

1. YES 5. NO 8. DK 9. RF

GO TO J205

J186

For how many people do you make pay and promotion decisions?

_____ DK RF

NUMBER OF PEOPLE

GO TO J205

J187

Are you paid a regular salary or wages?

1. YES 5. NO 8. DK 9. RF

GO TO J194

J188

How much are you paid before taxes and other deductions?

[IWER: DO NOT PROBE DK/RF]

[IWER: IF AMOUNT PER HOUR, ENTER BOTH DOLLARS AND CENTS]

[IWER: USE ZERO FOR NONE]

	0	DK	RF
AMOUNT			
GO TO J192	GO TO J194		

J189-J191 Unfolding Sequence

Question text: Does it amount to less than \$____ per year, more than \$____ per year, or what?

PROCEDURES: 2Up1Down, 1Up2Down

BREAKPOINTS: \$5,000, \$15,000, \$30,000, \$75,000

RANDOM ENTRY POINTS: \$15,000, \$30,000

ENTRY POINT ASSIGNMENT: 1 OR {NOT 1} AT X508

ORDER OF ENTRY POINT ASSIGNMENTS AND PROCEDURES CORRESPOND

J192 BRANCHPOINT: GO TO J194

J192

PER:

1. HOUR	2. WEEK	3. EVERY TWO WEEKS/BI-WEEKLY	4. MONTH	5. TWICE A MONTH
6. YEAR	7. OTHER (SPECIFY) _____ J193		8. DK	9. RF

J194

Do you receive some or all of the net earnings or profits?

DEFINITION: NET EARNING OR PROFIT IS TOTAL BUSINESS INCOMES LESS TOTAL BUSINESS EXPENSES.

1. YES	5. NO	8. DK	9. RF
--------	-------	-------	-------

J195 BRANCHPOINT: IF R IS PAID A REGULAR SALARY (J187=1) and R DID NOT RECEIVE NET EARNINGS OR PROFITS (J194 NOT 1), GO TO J201

J195

IF R NOT PAID REGULAR SALARY *and* DID NOT RECEIVE NET EARNINGS OR PROFITS (J187 *and* J194 NOT 1):

What did you earn last year?

IF R IS PAID REGULAR {SALARY OR WAGES} (J187=1):

In addition to your regular salary, how much do you receive from net earnings or profits?

OTHERWISE:

How much do you receive from net earnings or profits?

[IWER: IF R HAS TROUBLE GIVING DOLLAR FIGURE, ASK:]

What did you earn the last year you worked?

DEFINITION: NET EARNING OR PROFIT IS TOTAL BUSINESS INCOMES LESS TOTAL BUSINESS EXPENSES.

[IWER: DO NOT PROBE DK/RF]

[IWER: IF AMOUNT PER HOUR, ENTER BOTH DOLLARS AND CENTS]

[IWER: USE ZERO FOR NONE]

<hr style="width: 150px; margin: 0 auto;"/> <p>AMOUNT</p>	0	DK	RF
GO TO J199	GO TO J201		

J196-J198 Unfolding Sequence

Question text: Does it amount to less than \$____ per year, more than \$____ per year, or what?

PROCEDURES: 2Up1Down, 1Up2Down

BREAKPOINTS: \$3,000, \$10,000, \$25,000, \$65,000

RANDOM ENTRY POINTS: \$10,000, \$25,000

ENTRY POINT ASSIGNMENT: 1 OR {NOT 1} AT X509

ORDER OF ENTRY POINT ASSIGNMENTS AND PROCEDURES CORRESPOND

J199 BRANCHPOINT: GO TO J201

J199

PER:

1. HOUR	2. WEEK	3. EVERY TWO WEEKS/BI-WEEKLY	4. MONTH	5. TWICE A MONTH
6. YEAR	7. OTHER (SPECIFY) _____ J200		8. DK	9. RF

J201

Including yourself, how many people work in this business?

NUMBER OF PEOPLE

DK

RF

**GO TO J202
BRANCHPOINT**

J957

Is it fewer than 5, 5 to 14, 15 to 24, 25 to 49, 50 to 99, 100 to 499, or 500 or more?

1. FEWER THAN 5	2. 5 TO 14	3. 15 TO 24	4. 25 TO 49
5. 50 TO 99	6. 100 TO 499	7. 500 OR MORE	8. DK
			9. RF

J202 BRANCHPOINT: IF {{R HAS SAME SPOUSE/PARTNER AS R'S LAST IW (A020=1) or R'S FORMER PARTNER IS NOW HIS/HER SPOUSE (A020=3)} and R WAS SELF-EMPLOYED AT R'S LAST IW (Z136=2)} or R IS NOT MARRIED/PARTNERED (X065 {NOT 1 and NOT 3) or ONLY ONE PERSON WORKS IN THE BUSINESS (J201=1), GO TO J248

J202

Does your [husband/wife/partner] do any work for the business?

1. YES	5. NO	8. DK	9. RF
<p>GO TO J248</p>			

J203

How many hours a week does [he/she] usually work for the business?

NUMBER OF HOURS

DK

RF

J204

Is [he/she] paid a regular salary?

1. YES	5. NO	8. DK	9. RF
<p>GO TO J248</p>			

J205

Are you salaried on this job, paid by the hour, or what?

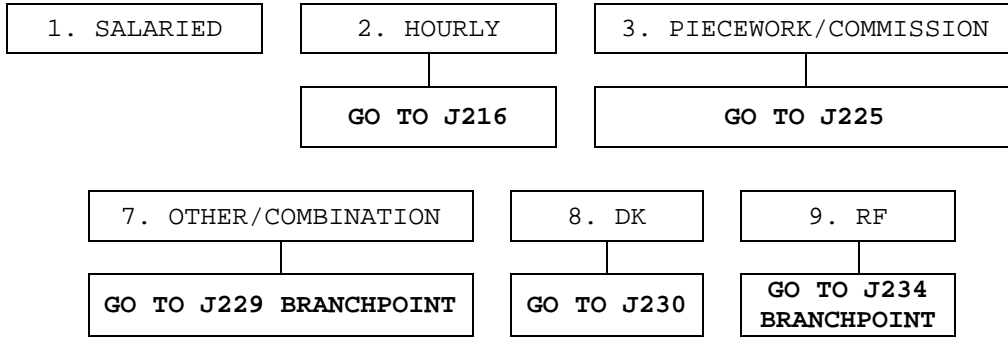

J206

How much is your salary, before taxes and other deductions?

[IWER: DO NOT PROBE DK/RF]

[IWER: IF RESPONDENT IS A TEACHER, RECORD ANNUAL SALARY]

[IWER: IF AMOUNT PER HOUR, ENTER BOTH DOLLARS AND CENTS]

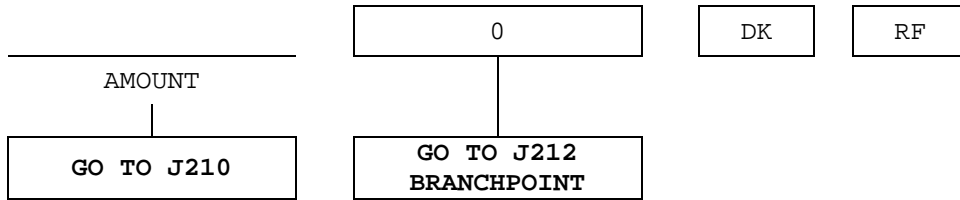

J207-J209 Unfolding Sequence

Question text: Does it amount to less than \$____ per year, more than \$____ per year, or what?

PROCEDURES: 2Up1Down, 1Up2Down

BREAKPOINTS: \$10,000, \$25,000, \$50,000, \$100,000

RANDOM ENTRY POINTS: \$25,000, \$50,000

ENTRY POINT ASSIGNMENT: 1 OR {NOT 1} AT X510

ORDER OF ENTRY POINT ASSIGNMENTS AND PROCEDURES CORRESPOND

J210 BRANCHPOINT: GO TO J212 BRANCHPOINT

J210

[IWER: PROBE IF NECESSARY]

Is that per hour, week, month, or year?

PER:

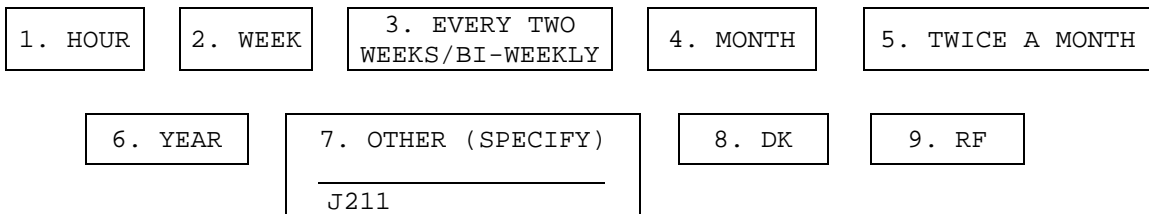

J212 BRANCHPOINT: IF R {REPORTED IN CURRENT IW THAT HAS MARGINAL EMPLOYMENT
and REPORTED IN LAST IW THAT HAD {MARGINAL EMPLOYMENT OR
NONE}} (J703=1), GO TO J244 BRANCHPOINT

J212

If you were to work more hours than usual during some weeks, would you get paid for those extra hours, get time off later, or get no compensation for the extra hours?

[IWER: IF TWO DIFFERENT RATES ARE GIVEN (E.G., DEPENDING ON DAY OF WEEK) PROBE FOR MOST FREQUENTLY USED RATE]

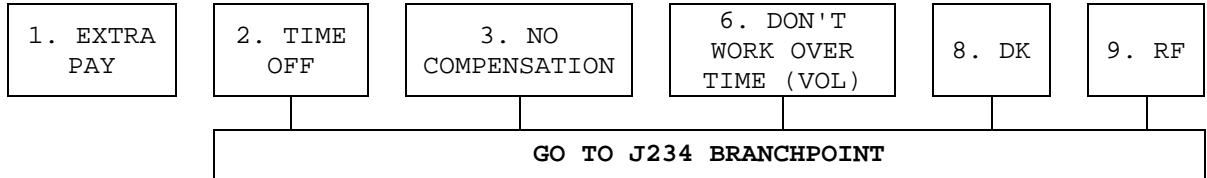

J213

About how much would you make per hour for those extra hours?

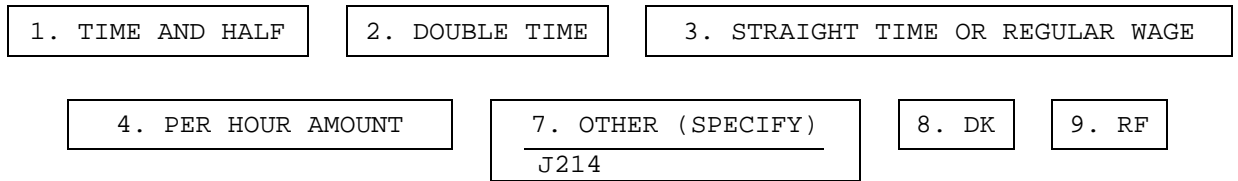

J215 BRANCHPOINT: IF R's OVERTIME RATE WAS NOT A PER HOUR AMOUNT (J213 NOT 4), GO TO J234 BRANCHPOINT

J215

[IWER: PROBE IF NECESSARY]

How much would you make per hour for each extra hour?

[IWER: BE SURE TO ENTER .00 FOR CENTS IF THERE ARE NONE]

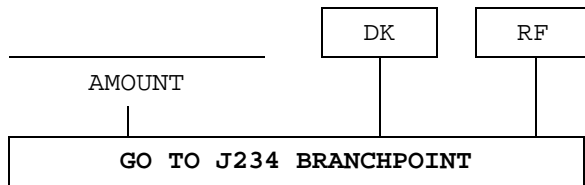

J216

What is your hourly wage rate for regular work time?

[IWER: DO NOT PROBE DK/RF]

[IWER: IF AMOUNT PER HOUR, ENTER BOTH DOLLARS AND CENTS]

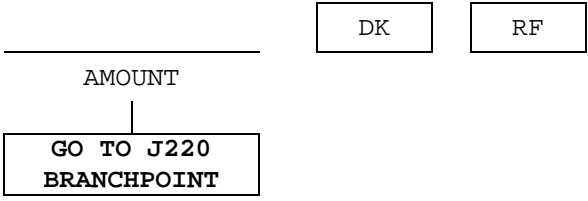

J217-J219 Unfolding Sequence

Question text: Does it amount to less than \$____ per hour, more than \$____ per hour, or what?

PROCEDURES: 2Up1Down, 1Up2Down

BREAKPOINTS: \$7.00, \$11.00, \$16.00, \$26.00

RANDOM ENTRY POINTS: \$11.00, \$16.00

ENTRY POINT ASSIGNMENT: 1 OR {NOT 1} AT X501

ORDER OF ENTRY POINT ASSIGNMENTS AND PROCEDURES CORRESPOND

J220 BRANCHPOINT: IF R {REPORTED IN CURRENT IW THAT HAS MARGINAL EMPLOYMENT and REPORTED IN LAST IW THAT HAD {MARGINAL EMPLOYMENT OR NONE}} (J703=1), GO TO J244 BRANCHPOINT

IF R DID NOT REPORT HOURLY WAGE RATE (J216 ={DK or RF}), GO TO J223

J220

What is your hourly wage rate for overtime?

[IWER: IF TWO DIFFERENT RATES ARE GIVEN (E.G., DEPENDING ON DAY OF WEEK) PROBE FOR MOST FREQUENTLY USED RATE]

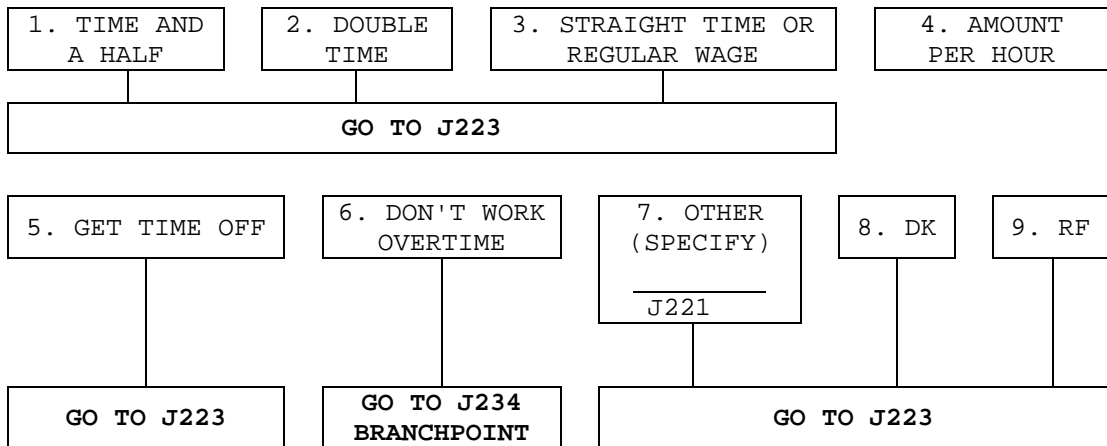

J222

(What is your hourly wage rate for overtime?)

[IWER: BE SURE TO ADD .00 FOR CENTS IF THERE ARE NONE]

0	DK	RF
---	----	----

AMOUNT PER HOUR

J223

During the last year, in how many weeks did you work some overtime?

0	DK	RF
---	----	----

WEEKS

GO TO J234 BRANCHPOINT

J224

Are you required to work overtime, or is it pretty much up to you?

1. REQUIRED	2. SOMETIMES REQUIRED	3. UP TO R	8. DK	9. RF
-------------	--------------------------	------------	-------	-------

GO TO J234 BRANCHPOINT

J225

What does that amount to, before taxes and other deductions, in an average week or month?

0	DK	RF
---	----	----

AMOUNT

GO TO J234 BRANCHPOINT

J226

[IWER: PROBE IF NECESSARY]

Is that per week or month?

PER:

1. HOUR	2. WEEK	3. EVERY TWO WEEKS/BI-WEEKLY	4. MONTH	5. TWICE A MONTH
---------	---------	---------------------------------	----------	------------------

6. YEAR	7. OTHER (SPECIFY) _____	8. DK	9. RF
---------	-----------------------------	-------	-------

J227

J228 BRANCHPOINT: IF R {REPORTED IN CURRENT IW THAT HAS MARGINAL EMPLOYMENT and REPORTED IN LAST IW THAT HAD {MARGINAL EMPLOYMENT OR NONE}} (J703=1), GO TO J244 BRANCHPOINT

J228

If you worked an extra hour, how much would you earn for that?

[IWER: BE SURE TO ADD .00 FOR CENTS IF THERE ARE NONE]

	0 NO EXTRA PAY OR TIME OFF	999,995 GET TIME OFF INSTEAD	DK	RF
AMOUNT				

J229 BRANCHPOINT: IF "OTHER/COMBINATION" WAS NOT SELECTED FOR HOW R WAS PAID (J205 NOT 7), GO TO J234 BRANCHPOINT

J229

How are you paid?

	DK	RF
HOW PAID		

J230

How much are you paid before taxes and other deductions?

[IWER: IF AMOUNT PER HOUR, ENTER BOTH DOLLARS AND CENTS]

	0	DK	RF
AMOUNT	GO TO J234 BRANCHPOINT		

J231

[IWER: PROBE IF NECESSARY]

Was that per hour, week, month, or year?

PER:

1. HOUR	2. WEEK	3. EVERY TWO WEEKS/BI-WEEKLY	4. MONTH	5. TWICE A MONTH
6. YEAR	7. OTHER (SPECIFY) _____ J232	8. DK	9. RF	

J233 BRANCHPOINT: IF R {REPORTED IN CURRENT IW THAT HAS MARGINAL EMPLOYMENT and REPORTED IN LAST IW THAT HAD {MARGINAL EMPLOYMENT OR NONE}} (J703=1), GO TO J244 BRANCHPOINT

J233

If you worked an extra hour, how much would you earn for that hour?

[IWER: IF AMOUNT PER HOUR, ENTER BOTH DOLLARS AND CENTS]

	0 NO EXTRA PAY OR TIME OFF	99,995 GET TIME OFF INSTEAD	DK	RF
AMOUNT				

J234 BRANCHPOINT: IF R {REPORTED IN CURRENT IW THAT HAS MARGINAL EMPLOYMENT and REPORTED IN LAST IW THAT HAD {MARGINAL EMPLOYMENT OR NONE}} (J703=1), GO TO J244 BRANCHPOINT

J234

[Not counting overtime hours, could/Could] you reduce the number of paid hours in your regular work schedule?

1. YES	5. NO	8. DK	9. RF
--------	-------	-------	-------

J235 BRANCHPOINT: IF R IS ABLE TO REDUCE WORK HOURS (J234=1) and R WORKS {30 OR MORE} HOURS PER WEEK (J172 ≥ 30), GO TO J940

IF R IS ABLE TO REDUCE WORK HOURS (J234=1) and R DID NOT REPORT WORKING AT LEAST 30 HOURS PER WEEK (J172 {<30 or = {DK or RF}}), GO TO J241

J235

Would you like to do so even if your earnings were reduced in the same proportion?

1. YES	5. NO	8. DK	9. RF
GO TO J241			

J236

How many hours would you like to work each week?

NUMBER OF HOURS	DK	RF
GO TO J241		

J940

If you wanted to work half time on this job, would your employer allow you to do that?

1. YES	3. ONLY TEMPORARILY	5. NO	8. DK	9. RF
GO TO J241				

J941

If you reduced to half time, would your pay be cut in proportion to your reduction in hours, would it be cut more than that, or would it be cut less than that?

1. CUT IN PROPORTION	2. CUT MORE	3. CUT LESS	8. DK	9. RF
-------------------------	----------------	----------------	-------	-------

J942

If you reduced to half time, would your health insurance benefits be reduced, eliminated, or kept the same?

1. REDUCED	2. ELIMINATED	3. KEPT THE SAME
6. DOESN'T HAVE HEALTH INSURANCE BENEFITS	8. DK	9. RF

J943

(If you reduced to half time,) would your eligibility for pension benefits be affected?

1. YES	5. NO	6. DOESN'T HAVE PENSION BENEFITS	8. DK	9. RF
--------	-------	-------------------------------------	-------	-------

J241

Could you increase the number of paid hours in your regular work schedule?

1. YES	5. NO	8. DK	9. RF
--------	-------	-------	-------

GO TO J244
BRANCHPOINT

J242

Would you like to do so if your earnings were increased in the same proportion?

1. YES	5. NO	8. DK	9. RF
--------	-------	-------	-------

GO TO J244 BRANCHPOINT

J243

How many hours would you like to work each week?

NUMBER OF HOURS

DK	RF
----	----

J244 BRANCHPOINT: IF R DID NOT REPORT THAT HAS SAME EMPLOYER AS AT LAST IW (J045 NOT {1 or 3}), CONTINUE ON TO J244

IF THE ALTERNATE WAVE FLAG IS NOT SET TO ASK QUESTIONS (J732>0), GO TO J263 BRANCHPOINT

NOTE: QUESTIONS J244 THROUGH J256 ARE ALWAYS ASKED OF NEW INTERVIEW Rs. ANY REINTERVIEW R WHO CHANGED HIS/HER EMPLOYER, OR FOR WHOM IT IS UNCERTAIN, SINCE R'S LAST IW (J045 NOT {1 or 3}) IS ASKED THIS SERIES.

IN ADDITION, ALL OTHER REINTERVIEW Rs WHO WORK FOR THE SAME EMPLOYER AS AT R'S LAST IW WERE LAST ASKED THIS SERIES IN 2008, AND WILL BE ASKED THIS SERIES EVERY 4TH WAVE THEREAFTER (E.G., IN 2016). **THESE Rs WILL NOT BE ASKED IN 2012.**

J244

About how many employees work for this company or organization **at the location where you work?**

[IWER: DO NOT PROBE DK/RF]

NUMBER OF EMPLOYEES

DK	RF
----	----

GO TO J246

J245

Is it fewer than 5, 5 to 14, 15 to 24, 25 to 49, 50 to 99, 100 to 499, or 500 or more?

1. FEWER THAN 5	2. 5 TO 14	3. 15 TO 24	4. 25 TO 49	
5. 50 TO 99	6. 100 TO 499	7. 500 OR MORE	8. DK	9. RF

J246

About how many employees work for this company or organization **at all locations?**

[IWER: DO NOT PROBE DK/RF]

[IWER: ENTER '-2' IF ONLY ONE LOCATION]

[IWER: IF R ASKS, EMPLOYEES WORKING AT HOME SHOULD BE INCLUDED.]

_____	DK	RF
NUMBER OF EMPLOYEES		
GO TO J248		

J247 BRANCHPOINT: IF AT LEAST 500 EMPLOYEES WORK AT R'S LOCATION (J244≥500 or J245=6), GO TO J248

J247

Is it fewer than 5, 5 to 14, 15 to 24, 25 to 49, 50 to 99, 100 to 499, or 500 or more?

1. FEWER THAN 5	2. 5 TO 14	3. 15 TO 24	4. 25 TO 49	
5. 50 TO 99	6. 100 TO 499	7. 500 OR MORE	8. DK	9. RF

J248

In what month and year did you start working for [this business/this employer]?

IF THIS IS A REINTERVIEW R (Z076=1):

[IWER: IF DATE GIVEN IS BEFORE R'S LAST IW MONTH, YEAR, PLEASE VERIFY WITH R]

IF R IS NOT SELF-EMPLOYED (J021 NOT 2):

[IWER: IF R WORKED MORE THAN ONCE FOR THIS EMPLOYER, ASK ABOUT FIRST HIRE]

J248

MONTH:

1. JAN	2. FEB	3. MAR	4. APR	5. MAY	6. JUN	7. JUL
8. AUG	9. SEP	10. OCT	11. NOV	12. DEC	98. DK	99. RF

DK	RF
----	----

J249
YEAR

J252 BRANCHPOINT: IF THIS IS NOT A REINTERVIEW R (Z076 NOT 1), GO TO J257 BRANCHPOINT

IF WE DON'T KNOW YEAR WHEN R {STOPPED LAST JOB or STARTED CURRENT JOB} ({J064 or J249}={DK or RF or EMPTY}), GO TO J257 BRANCHPOINT

IF YEAR R STOPPED WORKING FOR PREVIOUS EMPLOYER WAS {SAME OR BEFORE} YEAR R STARTED WORKING FOR CURRENT EMPLOYER (J064 ≤ J249), GO TO J257 BRANCHPOINT

J252

You told us that you started working for your current [business/employer] in YEAR BEGIN CURRENT EMPLOYER (per J249) and left your previous job in YEAR LEAVE PREVIOUS EMPLOYER per {J064 or J024}.

Is that correct?

1. YES	5. NO	8. DK	9. RF
--------	-------	-------	-------

GO TO J257 BRANCHPOINT

J253

Did you leave your previous employer in *YEAR LEAVE PREVIOUS EMPLOYER* per {J064 or J024}.

1. YES	5. NO	8. DK	9. RF
GO TO J255		GO TO J255	

J254

In what year did you stop working at your previous job?

_____ YEAR

9998. DK	9999. RF
----------	----------

J255

Did you start your current job in *YEAR BEGIN CURRENT EMPLOYER* (per J249)?

1. YES	5. NO	8. DK	9. RF
GO TO J257 BRANCHPOINT		GO TO J257 BRANCHPOINT	

J256

In what year did you start working at your current job?

_____ YEAR

9998. DK	9999. RF
----------	----------

J257 BRANCHPOINT: IF THIS IS REINTERVIEW R (Z076=1), GO TO J260 BRANCHPOINT

J257

What was your starting pay, before taxes and other deductions?

AMOUNT	0	DK	RF
	GO TO J260 BRANCHPOINT		

J258

[IWER: PROBE IF NECESSARY]

Was that per hour, week, month or year?

PER:

1. HOUR	2. WEEK	3. EVERY TWO WEEKS/BI-WEEKLY	4. MONTH	5. TWICE A MONTH
6. YEAR	7. OTHER (SPECIFY) _____ J259	8. DK	9. RF	

J260 BRANCHPOINT: IF R {REPORTED IN CURRENT IW THAT HAS MARGINAL EMPLOYMENT *and* REPORTED IN LAST IW THAT HAD {MARGINAL EMPLOYMENT OR NONE}} (J703=1), GO TO J478 (AFTER J266)

IF R WORKS FOR SAME EMPLOYER AS R'S LAST IW (J045={1 or 3}), GO TO J263 BRANCHPOINT

IF R IS NOT REINTERVIEW R, GO TO J263 BRANCHPOINT

IF R STARTED WORKING FOR CURRENT EMPLOYER LESS THAN 2 MONTHS FROM {MONTH *and* YEAR} OF CURRENT IW (per J248&J256 or J248&J249) or WE DON'T KNOW (MONTH or YEAR) WHEN R STARTED CURRENT JOB ({J248 or J249}={DK or RF or EMPTY}), GO TO J263 BRANCHPOINT

J260

Were there any months since [[MONTH, YEAR R STARTED CURRENT JOB (per J248&J256 or J248&J249)/R's LAST IW MONTH, YEAR/in the last two years] when you did not work for this [business/employer]?

1. YES	5. NO	8. DK	9. RF
GO TO J263 BRANCHPOINT			

BEGINNING OF JW777_4 LOOP: QUESTIONS JW777_4 AND JW778_4 ARE REPEATED FOR UP TO FOUR ELIGIBLE YEARS.

NOTE: ELIGIBLE YEARS ARE 2013 AND 2012, THE YEARS IN WHICH THERE COULD BE IWs FOR THIS HRS WAVE, AND 2011 & 2010, THE YEARS IN WHICH THERE WERE IWs FOR Rs IN THE PREVIOUS HRS WAVE. INDIVIDUAL Rs WILL BE ASKED QUESTIONS THAT APPLY ONLY TO THE YEARS THAT SPAN THE RANGE FOR THAT R's TWO INTERVIEWS, BEGINNING WITH THE MOST RECENT YEAR AND ENDING WITH THE YEAR OF THE PRIOR IW, OR 2010 IF THE R WAS NOT INTERVIEWED IN THE PREVIOUS HRS WAVE.

JW777_4 BRANCHPOINT: IF {YEAR R STARTED CURRENT JOB} (per J256/J249) or {R's LAST IW YEAR} and {CURRENT YEAR} ARE THE SAME, GO TO JW778_4

JW777_4

Were there any months in ELIGIBLE YEAR when you did not work for this [business/employer]?

1. YES	5. NO	8. DK	9. RF
GO TO END OF JW777_4 LOOP			

JW778_4 BRANCHPOINT: IF THERE IS ONLY ONE ELIGIBLE MONTH ON MONTHLIST, ASSIGN THAT MONTH TO JW778_4 AND GO TO THE END OF JW777_4 LOOP

JW778_4

Which months in ELIGIBLE YEAR were those (when you did not work for this [business/employer])?

[IWER: CHOOSE ALL THAT APPLY]

[IWER: ONLY ELIGIBLE MONTHS WILL APPEAR ON THE LIST]

[IWER: YOU MUST ENTER MONTH(S) FOR THIS QUESTION. IF YOU HAVE GOTTEN THIS QUESTION IN ERROR, BACK UP AND CHANGE ANSWER TO PREVIOUS QUESTION TO 'NO']

1. JAN	2. FEB	3. MAR	4. APR	5. MAY	6. JUN	7. JUL
--------	--------	--------	--------	--------	--------	--------

8. AUG	9. SEP	10. OCT	11. NOV	12. DEC	13. ALL
14. ALL MONTHS DISPLAYED		15. ALL MONTHS DISPLAYED		98. DK	99. RF

NOTE: THE ONLY MONTHS AND YEARS PRESENTED TO THE IWER ARE THOSE FROM R'S LAST IW UNTIL THE DATE R STOPPED WORKING FOR THAT EMPLOYER/BUSINESS. CODES 13, 14, AND 15 ARE NOT SHOWN IN THE DATA AND SHOULD NOT BE USED FOR ANALYSIS PURPOSES. THEY WILL ONLY SHOW IN THE CODEFRAME AS A CONVENIENCE FOR INTERVIEWERS WHEN APPROPRIATE.

END OF JW777_4 LOOP: QUESTIONS JW777_4 AND JW778_4 ARE REPEATED FOR UP TO FOUR ELIGIBLE YEARS. OTHERWISE, CONTINUE

JW786_4 BRANCHPOINT: IF {YEAR R STARTED CURRENT JOB} (per J256/J249) IS THE SAME or AFTER THE PREVIOUS HRS WAVE, GO TO J263 BRANCHPOINT

JW786_4

Were there any months between [MONTH, YEAR R STARTED CURRENT JOB (per J248&J256 or J248&J249)/R's LAST IW MONTH, YEAR/in the last two years] and January [FIRST YEAR OF PREVIOUS HRS WAVE DATA COLLECTION] when you did not work for this [business/employer]?

1. YES	5. NO	8. DK	9. RF
--------	-------	-------	-------

J263 BRANCHPOINT: IF R {REPORTED IN CURRENT IW THAT HAS MARGINAL EMPLOYMENT and REPORTED IN LAST IW THAT HAD {MARGINAL EMPLOYMENT OR NONE}} (J703=1), GO TO J478 (AFTER J266)

IF R IS CURRENTLY SELF-EMPLOYED (J021=2), GO TO J478 (AFTER J266)

J263

Has your employer experienced a permanent reduction in employment since [MONTH, YEAR R STARTED CURRENT JOB (per J248&J256 or J248&J249)/R's LAST IW MONTH, YEAR/YEAR 2 YEARS AGO]?

[IWER: CODE 'DOWNSIZING' AND PERMANENT LAYOFFS AS YES; CODE TEMPORARY LAYOFFS AS NO]

1. YES	5. NO	8. DK	9. RF
GO TO J720 BRANCHPOINT			

J264

Has this downsizing affected workers whose jobs are similar to yours?

1. YES	5. NO	8. DK	9. RF
--------	-------	-------	-------

J720 BRANCHPOINT: IF R DID NOT REPORT THAT HAS SAME EMPLOYER AS AT LAST IW (J045 NOT {1 or 3}), CONTINUE ON TO J720

IF THE ALTERNATE WAVE FLAG IS NOT SET TO ASK QUESTIONS (J731>0), GO TO J266 BRANCHPOINT

NOTE: QUESTIONS J720 AND J721 ARE ALWAYS ASKED OF NEW INTERVIEW Rs. ANY REINTERVIEW R WHO CHANGED HIS/HER EMPLOYER, OR FOR WHOM IT IS UNCERTAIN, SINCE R'S LAST IW (J045 NOT {1 or 3}) IS ASKED THIS SERIES.

IN ADDITION, ALL OTHER REINTERVIEW Rs WHO WORK FOR THE SAME EMPLOYER AS AT R'S LAST IW WERE LAST ASKED THIS SERIES IN 2010, AND WILL BE ASKED THIS SERIES EVERY 3rd WAVE THEREAFTER (E.G., IN 2012). THESE Rs WILL NOT BE ASKED IN 2012.

J720

Are you employed by the government at the federal, state, or local level?

This includes teachers and other service workers who are on the payrolls of local government, school districts, and other agencies of state and local government.

1. YES	5. NO	8. DK	9. RF
GO TO J266 BRANCHPOINT			

J721

Would that be the federal, state, or local government?

1. FEDERAL	2. STATE	3. LOCAL (COUNTY, CITY, TOWNSHIP)	8. DK	9. RF
------------	----------	-----------------------------------	-------	-------

J266 BRANCHPOINT: IF R DID NOT REPORT THAT HAS SAME EMPLOYER AS AT LAST IW (J045 NOT {1 or 3}) or R {DID NOT REPORT THAT HAS SAME JOB TITLE and DID NOT REPORT THAT IS RETIRED AND WORKING FOR SAME EMPLOYER} AS AT LAST IW (J058={NOT 1 and NOT 3}), CONTINUE ON TO J266

IF THE ALTERNATE WAVE FLAG IS NOT SET TO ASK QUESTIONS (J732>0), GO TO J478 (AFTER J266)

NOTE: J266 IS ALWAYS ASKED OF NEW INTERVIEW Rs. ANY REINTERVIEW R WHO CHANGED HIS/HER EMPLOYER OR JOB TITLE SINCE R'S LAST IW, OR FOR WHOM IT IS UNCERTAIN, ({J045 NOT {1 or 3}) or {J058 {NOT 1 and NOT 3}}) IS ALSO ASKED THIS SERIES.

IN ADDITION, ALL OTHER REINTERVIEW Rs WHO WORK FOR THE SAME EMPLOYER AS AT R'S LAST IW WERE LAST ASKED THIS SERIES IN 2008, AND WILL BE ASKED THIS SERIES EVERY 4TH WAVE THEREAFTER (E.G., IN 2016). **THESE Rs WILL NOT BE ASKED IN 2012.**

J266

Are you covered by a union or employee-association contract?

1. YES	5. NO	8. DK	9. RF
--------	-------	-------	-------

*-----Social Security-----
(J478-J845)

J478

Do you currently receive any income from Social Security?

1. YES	5. NO	8. DK	9. RF
GO TO J501 BRANCHPOINT		GO TO J501 BRANCHPOINT	

J479

Do you expect to receive Social Security benefits at some time in the future?

1. YES	5. NO	8. DK	9. RF
GO TO J501 BRANCHPOINT			

J719

Do you expect to get them based on your own work record only, from a current, previous or late spouse's work record only, or both?

1. R'S OWN RECORD ONLY	2. SPOUSE'S RECORD ONLY	3. BOTH RECORDS	8. DK	9. RF
------------------------	-------------------------	-----------------	-------	-------

J480

At what age do you expect to start collecting these benefits?

[IWER: IF R MENTIONS AGE AND SOME NUMBER OF MONTHS, E.G., 59 AND ½, ENTER AGE HERE AND GO TO THE NEXT SCREEN TO ENTER MONTHS]

30-96 AGE

_____	DK	RF
AGE	_____	

GO TO J487 BRANCHPOINT

J910

[IWER: IF R REPORTS AGE AND MONTHS, ENTER NUMBER OF MONTHS]

[IWER: IF R DID NOT MENTION MONTHS, PRESS [ENTER] TO CONTINUE]

1-12 NUMBER OF MONTHS

J481

If you start collecting Social Security benefits then, about how much do you expect the payments to be in today's dollars?

[IWER: DO NOT PROBE DK/RF]

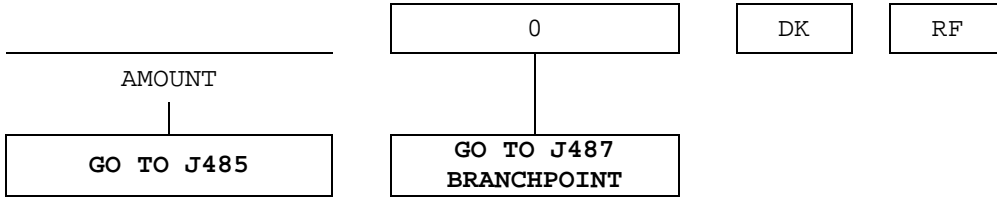

J482-J484 Unfolding Sequence

Question text: Do you expect it to be less than \$___ per month, more than \$___ per month, or what?

PROCEDURES: 2Up1Down, 1Up2Down

BREAKPOINTS: \$250, \$500, \$750, \$1,750

RANDOM ENTRY POINTS: \$500, \$750

ENTRY POINT ASSIGNMENT: 1 OR {NOT 1} AT X509

ORDER OF ENTRY POINT ASSIGNMENTS AND PROCEDURES CORRESPOND

J485 BRANCHPOINT: GO TO J487 BRANCHPOINT

J485

PER:

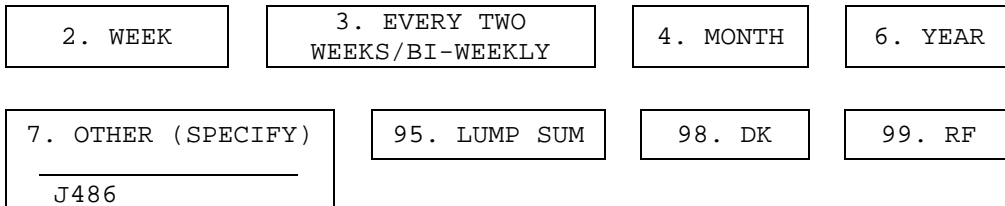

J487 BRANCHPOINT: IF THIS IS A PROXY (A009 NOT 1), GO TO J501 BRANCHPOINT

IF R's AGE IS GREATER THAN 62 (A019>62), GO TO J493 BRANCHPOINT

IF R EXPECTS TO START COLLECTING BENEFITS AT AGE 62 (J480=62), GO TO J493 BRANCHPOINT

J487

IF R's AGE IS LESS THAN 62:

R IS NOT RETIRED and NOT A HOMEMAKER (J005 NOT 5 and NOT 6):

If you were to retire at age 62 and collect benefits, what do you think your Social Security benefits would be in today's dollars?

IF R IS RETIRED or A HOMEMAKER (J005=5 or 6):

If you were to start collecting benefits at age 62, what do you think your Social Security benefits would be in today's dollars?

IF R's AGE IS 62:

R IS NOT RETIRED and NOT A HOMEMAKER (J005 NOT 5 and NOT 6):

If you were to retire now and collect benefits, what do you think your Social Security benefits would be in today's dollars?

IF R IS RETIRED or A HOMEMAKER (J005=5 or 6):

If you were to start collecting benefits now, what do you think your Social Security benefits would be in today's dollars?

[IWER: DO NOT PROBE DK/RF]

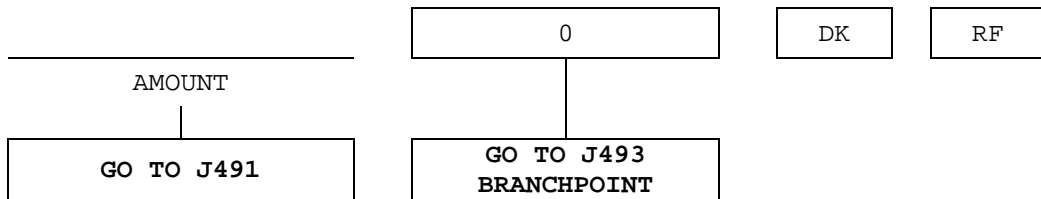

J488-J490 Unfolding Sequence

Question text: Do you expect it to be less than \$____ per month, more than \$____ per month, or what?

PROCEDURES: 2Up1Down, 1Up2Down

BREAKPOINTS: \$500, \$700, \$900, \$1,200

RANDOM ENTRY POINTS: \$700, \$900

ENTRY POINT ASSIGNMENT: 1 OR {NOT 1} AT X510

ORDER OF ENTRY POINT ASSIGNMENTS AND PROCEDURES CORRESPOND

J491 BRANCHPOINT: GO TO J493 BRANCHPOINT

J491

PER:

2. WEEK	3. EVERY TWO WEEKS/BI-WEEKLY	4. MONTH
6. YEAR	7. OTHER (SPECIFY) _____ J492	8. DK
		9. RF

J493 BRANCHPOINT: IF {R'S AGE IS GREATER THAN *SOCIAL SECURITY NORMAL RETIRMENT AGE*} (A019 > SSNRA), GO TO J501 BRANCHPOINT

IF R EXPECTS TO START COLLECTING BENEFITS AT *SOCIAL SECURITY NORMAL RETIREMENT AGE* (J480 = SSNRA), GO TO J501 BRANCHPOINT

SOCIAL SECURITY NORMAL RETIREMENT AGE (SSNRA)	
YEAR OF BIRTH	SS RETIREMENT AGE
1937 or earlier	65
1938	65 and 2 months
1939	65 and 4 months
1940	65 and 6 months
1941	65 and 8 months
1942	65 and 10 months
1943-1954	66
1955	66 and 2 months
1956	66 and 4 months
1957	66 and 6 months
1958	66 and 8 months
1959	66 and 10 months
1960 and later	67

J493

IF R's AGE IS LESS THAN SOCIAL SECURITY NORMAL RETIREMENT AGE (A019 < SSNRA):

R IS NOT RETIRED and NOT A HOMEMAKER (J005 NOT 5 and NOT 6):
 If you were to retire at your Social Security normal retirement age and collect benefits, what do you think your Social Security benefits would be in today's dollars?

IF R IS RETIRED or A HOMEMAKER (J005=5 or 6):
 If you were to start collecting benefits at your Social Security normal retirement age, what do you think your Social Security benefits would be in today's dollars?

IF R's AGE IS SOCIAL SECURITY NORMAL RETIREMENT AGE (A019=SSNRA):

R IS NOT RETIRED and NOT A HOMEMAKER (J005 NOT 5 and NOT 6):
 If you were to retire now and collect benefits, what do you think your Social Security benefits would be in today's dollars?

IF R IS RETIRED or A HOMEMAKER (J005=5 or 6):
 If you were to start collecting benefits now, what do you think your Social Security benefits would be in today's dollars?

[IWER: DO NOT PROBE DK/RF]

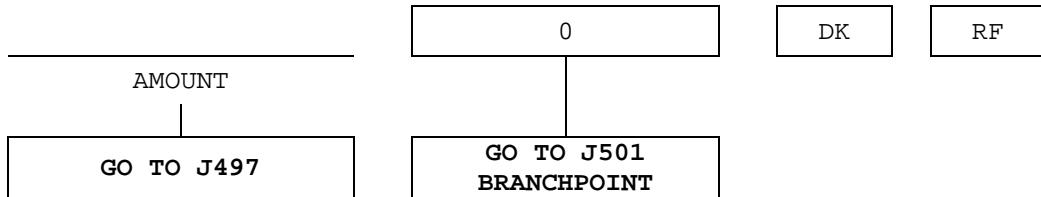

J494-J496 Unfolding Sequence

Question text: Do you expect it to be less than \$____ per month, more than \$____ per month, or what?

PROCEDURES: 2Up1Down, 1Up2Down
 BREAKPOINTS: \$600, **\$900**, **\$1,200**, \$1,500
 RANDOM ENTRY POINTS: \$900, \$1,200
 ENTRY POINT ASSIGNMENT: 1 OR {NOT 1} AT X501
 ORDER OF ENTRY POINT ASSIGNMENTS AND PROCEDURES CORRESPOND

J497 BRANCHPOINT: GO TO J501 BRANCHPOINT

J497

PER:

2. WEEK	3. EVERY TWO WEEKS/BI-WEEKLY	4. MONTH	
6. YEAR	7. OTHER (SPECIFY) _____	8. DK	9. RF

J498

J501 BRANCHPOINT: IF R IS IN NURSING HOME (A028=1) *and* HAS NO OTHER RESIDENCE OUTSIDE NURSING HOME (A070=5) *and* DID NOT REPORT THAT IS CURRENTLY WORKING (J020 NOT 1), GO TO J578

IF R REPORTED {IN CURRENT IW *and* IN THE LAST TWO WAVES} THAT WAS NOT WORKING (J705=1), GO TO J578

IF R {REPORTED IN CURRENT IW THAT HAD MARGINAL EMPLOYMENT *and* REPORTED IN LAST IW THAT HAD {MARGINAL EMPLOYMENT OR NONE}} (J703=1), GO TO J578

IF THIS IS A PROXY INTERVIEW *and* R IS CURRENTLY WORKING (J020=1), GO TO J505 BRANCHPOINT

IF THIS IS A PROXY INTERVIEW *and* R IS NOT CURRENTLY WORKING (J020 NOT 1), GO TO J596 BRANCHPOINT

IF R IS NOT CURRENTLY WORKING (J020 NOT 1), GO TO J517

IF R IS CURRENTLY SELF-EMPLOYED (J021=2) *and* R WAS SELF-EMPLOYED AT R'S LAST IW (Z136=2) *and* {{{START DATE FOR CURRENT JOB per J248&J256 or J248&J249} ≤ R'S LAST IW MONTH, YEAR} or WE DON'T KNOW (MONTH or YEAR) WHEN R STARTED CURRENT JOB ({J248 or J249}={DK or RF or EMPTY})}, GO TO J505 BRANCHPOINT

IF R DID NOT REPORT THAT HAS SAME EMPLOYER AS AT LAST IW (J045 NOT {1 or 3}) or R {DID NOT REPORT THAT HAS SAME JOB TITLE *and* DID NOT REPORT THAT IS RETIRED AND WORKING FOR SAME EMPLOYER} AS AT LAST IW (J058={NOT 1 *and* NOT 3}), CONTINUE ON TO J501

IF THE ALTERNATE WAVE FLAG IS NOT SET TO ASK QUESTIONS (J732>0), GO TO J505 BRANCHPOINT

*-----Job Requirements/Characteristics and Second Jobs-----
(J501-J563)

NOTE: QUESTIONS J501 THROUGH J676 ARE ALWAYS ASKED OF NEW INTERVIEW RS. ANY REINTERVIEW R WHO CHANGED HIS/HER EMPLOYER OR JOB TITLE SINCE R'S LAST IW, OR FOR WHOM IT IS UNCERTAIN, ({J045 NOT {1 or 3}}) or {J058 {NOT 1 and NOT 3}}) IS ALSO ASKED THIS SERIES.

IN ADDITION, ALL OTHER REINTERVIEW RS WHO WORK FOR THE SAME EMPLOYER AS AT R'S LAST IW and HAVE THE SAME TITLE WERE LAST ASKED THIS SERIES IN 2008, AND WILL BE ASKED THIS SERIES EVERY 4TH WAVE THEREAFTER (E.G., IN 2016). THESE RS WILL NOT BE ASKED IN 2012.

J501

Now we have some questions about your work experience.

Counting high school graduation as 12 years, about how many years of school would you say are needed to do your job reasonably well?

NUMBER OF YEARS

DK	RF
GO TO J505 BRANCHPOINT	

J502

(For someone with this much formal schooling,) About how much experience do you think it would take to become good at your job?

AMOUNT OF EXPERIENCE

0	DK	RF
GO TO J676	GO TO J505 BRANCHPOINT	

J503

UNIT:

1. HOURS	2. WEEKS	4. MONTHS	6. YEARS
7. OTHER (SPECIFY) _____		8. DK	9. RF

J504

J676 (Tag#=J504.1)

Is your current job covered by FICA where social security taxes are paid?

(Do you pay social security taxes?)

1. YES	5. NO	8. DK	9. RF
--------	-------	-------	-------

J505 BRANCHPOINT: IF THIS IS A PROXY INTERVIEW *and* R IS CURRENTLY WORKING (J020=1), GO TO J553

NOTE: THIS BRANCHPOINT IS INTENDED TO JUMP OUT THOSE WHO JUMPED TO J676 UNDER IDENTICAL CONDITIONS AT THE 501 BRANCHPOINT

J505

Sometimes people look for a different job even when they are currently working. Are you currently looking for another job?

1. YES	5. NO	8. DK	9. RF
GO TO J514			

J506

Are you looking for jobs only in the area where you live, or are you considering jobs that would require you to move?

1. JOBS IN THIS AREA	2. JOBS REQUIRING A MOVE	3. BOTH/EITHER ONE	8. DK	9. RF
----------------------	--------------------------	--------------------	-------	-------

J507

Are you looking for part-time or full-time work?

1. PART-TIME	2. FULL-TIME	3. EITHER KIND	8. DK	9. RF
--------------	--------------	----------------	-------	-------

J508

Are you looking for the same kind of work you're doing now, or something different?

1. SAME	2. EITHER/BOTH	3. DIFFERENT	8. DK	9. RF
GO TO J510			GO TO J510	

J509

How would it be different?

DK	RF
----	----

J510

During the past four weeks, what have you been doing to find another job?

[IWER: DO NOT READ CATEGORIES. CHOOSE ALL THAT APPLY.]

1. CHECKED WITH PUBLIC EMPLOYMENT AGENCY

2. CHECKED WITH PRIVATE EMPLOYMENT AGENCY

3. VISITED EMPLOYERS DIRECTLY

4. TELEPHONED OR WROTE EMPLOYERS DIRECTLY

5. ASKED FRIENDS OR RELATIVES

6. PLACED OR ANSWERED ADS

7. READ ADS

8. DIDN'T DO ANYTHING SPECIFIC

97. OTHER (SPECIFY)
J511

98. DK

99. RF

J512 BRANCHPOINT: IF R DID NOT VISIT EMPLOYERS DIRECTLY (J510 NOT 3), GO TO J513 BRANCHPOINT

J512

How many employers did you visit?

NUMBER OF EMPLOYERS

DK

RF

J513 BRANCHPOINT: IF R DID NOT {TELEPHONE OR WRITE} EMPLOYERS DIRECTLY (J510 NOT 4), GO TO J514 BRANCHPOINT

J513

How many employers did you call or write?

NUMBER OF EMPLOYERS

DK

RF

J514 BRANCHPOINT: IF R WAS ASKED WHAT S/HE WAS DOING TO FIND ANOTHER JOB AT J510, GO TO J517 BRANCHPOINT

J514

If you found out about another job like the one you have now, would you look into it?

1. YES

2. PROBABLY

3. MAYBE

4. PROBABLY NOT

5. NO

7. OTHER (SPECIFY)
J515

8. DK

9. RF

J517 BRANCHPOINT: GO TO J537

J517

Have you been doing anything to find work during the last four weeks?

1. YES	5. NO	8. DK	9. RF
GO TO J527			

J518

Are you looking for part-time or full-time work?

1. PART-TIME	2. FULL-TIME	3. EITHER KIND	8. DK	9. RF
--------------	--------------	----------------	-------	-------

J519

Are you looking for the same kind of work you did before, or something different?

1. SAME	2. DIFFERENT	3. EITHER OR BOTH	8. DK	9. RF
GO TO J521	GO TO J521			

J520

How would it be different?

_____	DK	RF

J521

If you were to be offered work like that, how high would the wage or salary have to be for you to take it?

[IWER: IF R SAYS 'NO AMOUNT', ENTER [-2]]

[IWER: IF AMOUNT PER HOUR, ENTER BOTH DOLLARS AND CENTS]

[IWER: DO NOT PROBE DK/RF]

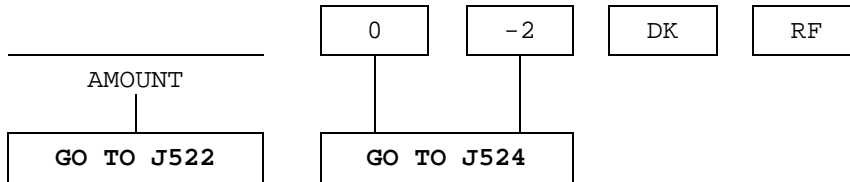

J842-J844 Unfolding Sequence

Question text: Would it amount to less than \$____ per year, more than \$____ per year, or what?

PROCEDURES: 2Up1Down, 1Up2Down

BREAKPOINTS: \$12,000, \$16,000, \$20,000, \$32,000

RANDOM ENTRY POINTS: \$16,000, \$20,000

ENTRY POINT ASSIGNMENT: 1 OR {NOT 1} AT X502

ORDER OF ENTRY POINT ASSIGNMENTS AND PROCEDURES CORRESPOND

J522 BRANCHPOINT: GO TO J524

J522

[IWER: PROBE IF NECESSARY]

Is that per hour, week, month, or year?

PER:

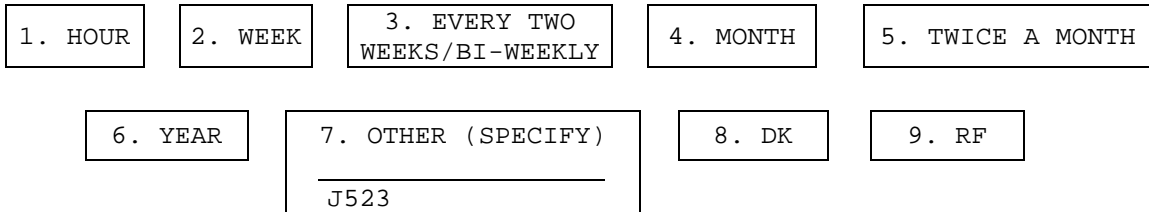

J524

What are all of the things you have done to find work during the last four weeks?

[IWER: DO NOT READ CATEGORIES. CHOOSE ALL THAT APPLY.]

1. READ ADS	2. ATTEND SCHOOL OR RECEIVED OTHER TRAINING	3. CHECKED WITH PUBLIC EMPLOYMENT AGENCY	4. CHECK WITH PRIVATE EMPLOYMENT AGENCY
5. VISITED EMPLOYERS DIRECTLY	6. TELEPHONED OR WROTE EMPLOYERS DIRECTLY	7. ASKED FRIENDS OR RELATIVES	8. PLACED OR ANSWERED ADS
96. DIDN'T DO ANYTHING SPECIFIC	97. OTHER (SPECIFY) _____	98. DK	99. RF

GO TO J535

NOTE: CODE "96. DIDN'T DO ANYTHING SPECIFIC" CANNOT BE SELECTED WITH ANY OTHER CODE.

J526 BRANCHPOINT: IF R {DID NOT VISIT and DID NOT TELEPHONE} ANY EMPLOYERS DIRECTLY (J524 {NOT 5 and NOT 6}), GO TO J578

J526

How many employers did you [visit/call or write/visit, call, or write]?

NUMBER OF EMPLOYERS VISITED,
CALLED OR WRITTEN

DK	RF
----	----

GO TO J578

J527

Do you currently want a job, either full-time or part-time?

1. YES	3. DEPENDS	5. NO	6. CAN'T WORK	8. DK	9. RF
		GO TO J529	GO TO J578	GO TO J529	

J528

Would you prefer part-time or full-time?

1. PART-TIME	2. FULL-TIME	3. EITHER	8. DK	9. RF
--------------	--------------	-----------	-------	-------

J529

If someone offered you a regular job now, how high would the wage or salary have to be for you to take it?

[IWER: DO NOT PROBE DK/RF]

[IWER: IF R SAYS 'NO AMOUNT', ENTER [-2]]

[IWER: IF R SAYS 'UNABLE TO WORK', ENTER [-3]]

[IWER: IF AMOUNT PER HOUR, ENTER BOTH DOLLARS AND CENTS]

AMOUNT	0	-2	-3	DK	RF
GO TO J533	GO TO J535		GO TO J578		

J530-J532 Unfolding Sequence

Question text: Would it amount to less than \$____ per year, more than \$____ per year, or what?

PROCEDURES: 2Up1Down, 1Up2Down

BREAKPOINTS: \$12,000, \$16,000, \$20,000, \$32,000

RANDOM ENTRY POINTS: \$16,000, \$20,000

ENTRY POINT ASSIGNMENT: 1 OR {NOT 1} AT X503

ORDER OF ENTRY POINT ASSIGNMENTS AND PROCEDURES CORRESPOND

J533 BRANCHPOINT: GO TO J535

J533

[IWER: PROBE IF NECESSARY]

Is that per hour, week, month, or year?

PER:

1. HOUR	2. WEEK	3. EVERY TWO WEEKS/BI-WEEKLY	4. MONTH	5. TWICE A MONTH
---------	---------	------------------------------	----------	------------------

6. YEAR	7. OTHER (SPECIFY) _____ J534	8. DK	9. RF
---------	-------------------------------------	-------	-------

J535

What is the main reason you were not looking for work during the last four weeks?

[IWER: DO NOT READ CATEGORIES]

1. BELIEVES NOTHING AVAILABLE IN LINE OF WORK	2. DOESN'T BELIEVE CAN FIND WORK	3. DOESN'T HAVE NEEDED SKILLS/EXPERIENCE	4. BELIEVES EMPLOYERS THINK TOO OLD	
5. BELIEVES EMPLOYERS WON'T HIRE OLDER WOMEN OR MINORITIES	6. POOR HEALTH, DISABILITY	7. FAMILY RESPONSIBILITIES /CHILD RESPONSIBILITIES	8. TRANSPORTATION PROBLEMS	
9. R DOESN'T WANT A JOB	95. NO PARTICULAR REASON	97. OTHER (SPECIFY) _____ J536	98. DK	99. RF

J537 BRANCHPOINT: GO TO J578

J537

I'll read some statements that are true for some people's jobs but not for other people's jobs. Thinking of your job, please tell me how often these statements are true.

1. CONTINUE

J538 BRANCHPOINT: IF R DID NOT REPORT THAT HAS SAME EMPLOYER AS AT LAST IW (J045 NOT {1 or 3}) or R {DID NOT REPORT THAT HAS SAME JOB TITLE and DID NOT REPORT THAT IS RETIRED AND WORKING FOR SAME EMPLOYER} AS AT LAST IW (J058={NOT 1 and NOT 3}), CONTINUE ON TO J538

IF THE ALTERNATE WAVE FLAG IS NOT SET TO ASK QUESTIONS (J732>0), GO TO J544

NOTE: QUESTIONS J538 THROUGH J543 ARE ALWAYS ASKED OF NEW INTERVIEW RS. ANY REINTERVIEW R WHO CHANGED HIS/HER EMPLOYER OR JOB TITLE SINCE R'S LAST IW, OR FOR WHOM IS UNCERTAIN, ({J045 NOT {1 or 3}} or {J058 {NOT 1 and NOT 3}}) IS ALSO ASKED THIS SERIES.

IN ADDITION, ALL OTHER REINTERVIEW RS WHO HAVE THE SAME JOB TITLE AS AT R'S LAST IW WERE LAST ASKED THIS SERIES IN 2008, AND WILL BE ASKED THIS SERIES EVERY 4TH WAVE THEREAFTER (E.G., IN 2016). **THESE RS WILL NOT BE ASKED IN 2012.**

	1. ALL OR ALMOST ALL OF THE TIME	2. MOST OF THE TIME	3. SOME OF THE TIME	4. NONE OR ALMOST NONE OF THE TIME	5. DOES NOT APPLY	8. DK	9. RF
J538 My job requires lots of physical effort. Is this true all or almost all of the time, most of the time, some of the time, or none or almost none of the time?							
J539 (My job requires) lifting heavy loads. (Is this true all or almost all of the time, most of the time, some of the time, or none or almost none of the time?)							
J540 (My job requires) stooping, kneeling, or crouching. (Is this true all or almost all of the time, most of the time, some of the time, or none or almost none of the time?)							
J541 (My job requires) good eyesight. (Is this true all or almost all of the time, most of the time, some of the time, or none or almost none of the time?)							

<p>J542 (My job requires) intense concentration or attention. (Is this true all or almost all of the time, most of the time, some of the time, or none or almost none of the time?)</p>						
<p>J543 (My job requires) skill in dealing with other people. (Is this true all or almost all of the time, most of the time, some of the time, or none or almost none of the time?)</p>						

J544

IF R WAS READ J538 (J538 NOT Empty):
 (My job requires) me to work with computers. (Is this true all or almost all of the time, most of the time, some of the time, or none or almost none of the time?)

OTHERWISE:

Thinking of your job, please tell me how often this statement is true.

My job requires me to work with computers. Is this true all or almost all of the time, most of the time, some of the time, or none or almost none of the time?

1. ALL OR ALMOST ALL OF THE TIME	2. MOST OF THE TIME	3. SOME OF THE TIME
----------------------------------	---------------------	---------------------

4. NONE OR ALMOST NONE OF THE TIME	8. DK	9. RF
------------------------------------	-------	-------

J545

Here are some (more) statements that are true for some people's jobs but not for others. (Again) Thinking of your job, (this time) please indicate how much you agree or disagree with each statement.

1. CONTINUE

	1. STRONGLY AGREE	2. AGREE	3. DISAGREE	4. STRONGLY DISAGREE	5. DOES NOT APPLY	8. DK	9. RF
<p>J546</p> <p>My job requires me to do more difficult things than it used to.</p> <p>Do you strongly agree, agree, disagree or strongly disagree with that statement?</p>							
<p>J547</p> <p>My job involves a lot of stress.</p> <p>Do you strongly agree, agree, disagree or strongly disagree with that statement?</p>							

J548 BRANCHPOINT: IF R IS SELF-EMPLOYED (J021=2), GO TO J550

	1. STRONGLY AGREE	2. AGREE	3. DISAGREE	4. STRONGLY DISAGREE	5. DOES NOT APPLY	8. DK	9. RF
<p>J548</p> <p>In decisions about promotion, my employer gives younger people preference over older people.</p> <p>(Do you strongly agree, agree, disagree or strongly disagree with that statement?)</p>							
<p>J549</p> <p>My co-workers make older workers feel that they ought to retire before age 65.</p> <p>(Do you strongly agree, agree, disagree or strongly disagree with that statement?)</p>							
<p>J550</p> <p>As I get older, I would prefer to gradually reduce the hours I work on this job, keeping my pay per hour the same.</p> <p>(Do you strongly agree, agree, disagree or strongly disagree with that statement?)</p>							

J551 BRANCHPOINT: IF R IS SELF-EMPLOYED (J021=2), GO TO J552

	1. STRONGLY AGREE	2. AGREE	3. DISAGREE	4. STRONGLY DISAGREE	5. DOES NOT APPLY	8. DK	9. RF
J551 My employer would let older workers move to a less demanding job with less pay if they wanted to. (Do you strongly agree, agree, disagree or strongly disagree with that statement?)							
J552 I really enjoy going to work. (Do you strongly agree, agree, disagree or strongly disagree with that statement?)							

J553

Now I have some questions about any other paid job you may have.

Are you doing any other work for pay now, such as (a/another) business of your own, a second job or the military reserves?

1. YES	5. NO	8. DK	9. RF
GO TO J564			

J554

Is this your own business, a second job, the military reserves, or what?

[IWER: CHOOSE ALL THAT APPLY]

1. OWN BUSINESS	2. SECOND JOB	3. MILITARY RESERVES	7. OTHER (SPECIFY) _____ J555	8. DK	9. RF
-----------------	---------------	----------------------	-------------------------------------	-------	-------

J556

How many hours a week do you usually work on [this other job/these other jobs]?

HOURS

DK

RF

J557

Counting paid vacations as weeks of work, how many weeks a year do you usually work on (this other job/these other jobs)?

[IWER: THIS REFERS TO USUAL WEEKS OF WORK ON RS SECOND/OTHER JOB(S)]

WEEKS

DK

RF

J558

About how much do you earn before taxes from [this other job/these other jobs]?

[IWER: DO NOT PROBE DK/RF]

[IWER: IF AMOUNT PER HOUR, ENTER BOTH DOLLARS AND CENTS]

AMOUNT

0

DK

RF

GO TO J562

GO TO J564

J559-J561 Unfolding Sequence

Question text: Does it amount to less than \$____ per year, more than \$____ per year, or what?

PROCEDURES: 2Up1Down, 1Up2Down

BREAKPOINTS: \$5,000, \$10,000, \$20,000, \$30,000

RANDOM ENTRY POINTS: \$10,000, \$20,000

ENTRY POINT ASSIGNMENT: 1 OR {NOT 1} AT X504

ORDER OF ENTRY POINT ASSIGNMENTS AND PROCEDURES CORRESPOND

J562 BRANCHPOINT: GO TO J564

J562

[IWER: PROBE IF NECESSARY]

Is that per hour, week, month, year, or what?

PER:

1. HOUR

2. WEEK

3. EVERY TWO WEEKS/BI-WEEKLY

4. MONTH

5. TWICE A MONTH

6. YEAR	7. OTHER (SPECIFY) _____ J563	8. DK	9. RF
---------	-------------------------------------	-------	-------

*-----Retirement Plans/Retirement Satisfaction-----
(J564-J594)

J564

Next I have a few questions about work and retirement.

On your main job, what is the usual retirement age for people who work with you or have the same kind of job?

_____ 40-94 YEARS OF AGE	95 NO USUAL AGE	96 ANSWER IN YEARS OF SERVICE	DK	RF
GO TO J566 BRANCHPOINT		GO TO J566 BRANCHPOINT		

J565

ENTER USUAL NUMBER OF YEARS OF SERVICE:

_____ 1-50 YEARS OF SERVICE	DK	RF
-----------------------------------	----	----

J566 BRANCHPOINT: IF THIS IS A PROXY INTERVIEW, GO TO J596 BRANCHPOINT

J566

Now I want to ask about your retirement plans.

Do you plan to stop working altogether or reduce work hours at a particular date or age, have you not given it much thought, or what?

[IWER: DO NOT PROBE]

1. STOP WORK ALTOGETHER	2. NEVER STOP WORK	3. NOT GIVEN MUCH THOUGHT	4. NO CURRENT PLANS, CONTINUE AS IS
5. REDUCE WORK HOURS	6. CHANGE KIND OF WORK	7. WORK FOR MYSELF	8. WORK UNTIL MY HEALTH FAILS
97. OTHER (SPECIFY) _____ J567		98. DK	99. RF

J568 BRANCHPOINT: IF R PLANS TO STOP WORKING ALTOGETHER (J566=1),
CONTINUE ON TO J568

OTHERWISE, GO TO J570 BRANCHPOINT

J568

At what age do you plan to stop working?

25-94 YEARS OF AGE

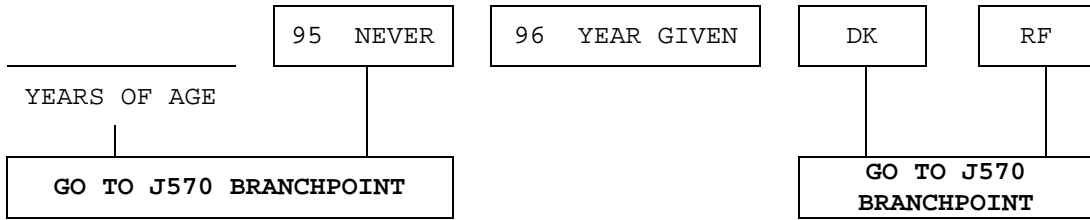

J569

ENTER YEAR PLANNING TO STOP WORKING:

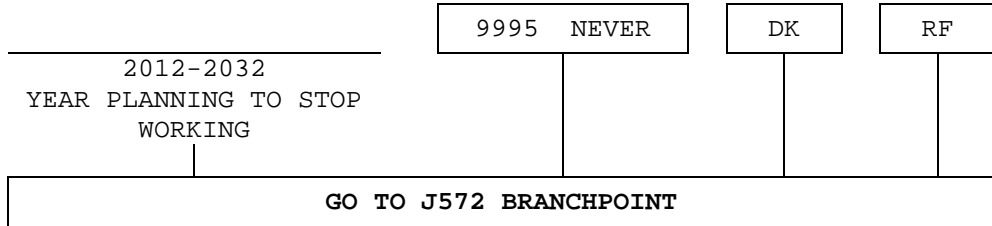

J570 BRANCHPOINT: IF R SAID {HAD NOT GIVEN MUCH THOUGHT *or* HAD NO CURRENT}
RETIREMENT PLANS (J566={3 *or* 4}), CONTINUE ON TO J570

OTHERWISE, GO TO J572 BRANCHPOINT

J570

At what age do you think you will stop working?

25-94 YEARS OF AGE

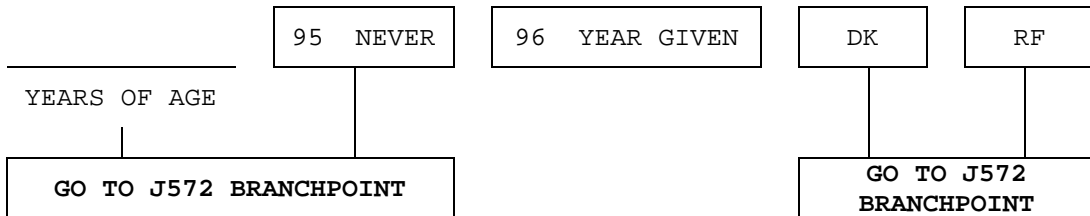

J571

ENTER YEAR THINKING TO STOP WORKING:

2012-2032
YEAR THINKING TO
STOP WORKING

9995 NEVER DK RF

J572 BRANCHPOINT: IF R DID NOT SAY S/HE PLANS TO REDUCE WORK HOURS (J566 NOT 5), GO TO J574 BRANCHPOINT

J572

At what age do you plan to start working fewer hours?

25-94 YEARS OF AGE

YEARS OF AGE

95 NEVER 96 YEAR GIVEN DK RF

GO TO J574 BRANCHPOINT GO TO J574 BRANCHPOINT

J573

ENTER YEAR PLANNING TO START WORKING FEWER HOURS:

2012-2062
YEAR PLANNING TO START
WORKING FEWER HOURS

DK RF

J574 BRANCHPOINT: IF R DID NOT SAY S/HE PLANS TO CHANGE KIND OF WORK (J566 NOT 6), GO TO J576 BRANCHPOINT

J574

At what age do you plan to change the kind of work you do?

25-94 YEARS OF AGE

YEARS OF AGE

95 NEVER 96 YEAR GIVEN DK RF

GO TO J576 BRANCHPOINT GO TO J576 BRANCHPOINT

J575

ENTER YEAR PLANNING TO CHANGE WORK:

2012-2062
YEAR PLANNING TO
CHANGE WORK

DK RF

J576 BRANCHPOINT: IF R DOES NOT PLAN TO WORK FOR HIM/HERSELF (J566 NOT 7), GO TO J578

J576

At what age do you plan to start working for yourself?

25-94 YEARS OF AGE

YEARS OF AGE

95 NEVER 96 YEAR GIVEN DK RF

GO TO J578 GO TO J578

J577

ENTER YEAR PLANNING TO START SELF-EMPLOYMENT:

2012-2062
YEAR STARTING SELF
EMPLOYMENT

DK RF

J578

We are interested in what people think about retirement, whether they themselves are retired or not.

At this time do you consider yourself partly retired, completely retired, or not retired at all?

1. COMPLETELY RETIRED 3. PARTLY RETIRED 5. NOT RETIRED AT ALL

GO TO J709 (AFTER J581)

7. QUESTION NOT RELEVANT TO R, DOESN'T WORK FOR PAY OR IS HOMEMAKER, ETC. 8. DK 9. RF

GO TO J596 BRANCHPOINT

J580 BRANCHPOINT: IF R IS COMPLETELY RETIRED NOW (J578=1) and {WAS COMPLETELY RETIRED AT R'S LAST IW (Z134=1) or {R WAS RETIRED and WE DON'T KNOW WHETHER IT WAS COMPLETELY (Z124=1 and {Z134 = EMPTY}}}}, GO TO J709 (AFTER J581)

IF R IS PARTLY RETIRED (J578=3) and WAS PARTLY RETIRED AT R'S LAST IW (Z134=3), GO TO J709 (AFTER J581)

IF R GAVE YEAR S/HE RETIRED AT J018, GO TO J709 (AFTER J581)

J580

In what month and year did you [partly/completely] retire?

[IWER: MONTH ENTERED MUST BE BEFORE CURRENT IW MONTH, YEAR]

J580

MONTH:

1. JAN	2. FEB	3. MAR	4. APR	5. MAY	6. JUN	7. JUL
8. AUG	9. SEP	10. OCT	11. NOV	12. DEC	98. DK	99. RF

DK	RF
----	----

_____ J581

YEAR

J709 (Tag#=J581.1)

IF R IS PARTLY RETIRED OR IS NOT RETIRED (J578={3 or 5}):

How much have you thought about retirement — a lot, some, a little, or hardly at all?

IF R IS COMPLETELY RETIRED (J578=1):

Before you retired, how much did you think about retirement — a lot, some, a little, or hardly at all?

1. A LOT	2. SOME	3. A LITTLE	4. HARDLY AT ALL	8. DK	9. RF
----------	---------	-------------	------------------	-------	-------

J583 BRANCHPOINT: IF R IS IN NURSING HOME (A028=1) *and* HAS NO OTHER RESIDENCE OUTSIDE NURSING HOME (A070=5) *and* DID NOT REPORT THAT IS CURRENTLY WORKING (J020 NOT 1), GO TO J650 (J ASSIST)

IF R REPORTED {IN CURRENT IW *and* IN THE LAST TWO WAVES} THAT WAS NOT WORKING (J705=1) *and* R IS NOT COMPLETELY RETIRED (J578 NOT 1), GO TO J650 (J ASSIST)

IF R REPORTED {IN CURRENT IW *and* IN THE LAST TWO WAVES} THAT WAS NOT WORKING (J705=1), GO TO J584 BRANCHPOINT

IF R {REPORTED IN CURRENT IW THAT HAD MARGINAL EMPLOYMENT *and* REPORTED IN LAST IW THAT HAD {MARGINAL EMPLOYMENT OR NONE}} (J703=1), GO TO J612 BRANCHPOINT

IF R IS NOT RETIRED AT ALL (J578=5), GO TO J589 BRANCHPOINT

IF R IS PARTLY RETIRED (J578=3) *and* {WAS PARTLY RETIRED AT R'S LAST IW (Z134=3) *or* {R WAS RETIRED *and* WE DON'T KNOW WHETHER IT WAS PARTLY (Z124=1 *and* {Z134 = EMPTY})}}, GO TO J589 BRANCHPOINT

IF R IS COMPLETELY RETIRED NOW (J578=1) *and* {WAS COMPLETELY RETIRED AT R'S LAST IW (Z134=1) *or* {R WAS RETIRED *and* WE DON'T KNOW WHETHER IT WAS COMPLETELY (Z124=1 *and* {Z134 = EMPTY})}}, GO TO J584

J583

Thinking back to the time you [partly/completely] retired, was that something you wanted to do or something you felt you were forced into?

- | | | | | |
|--------------------|-------------------|--------------------------------|-------|-------|
| 1. WANTED
TO DO | 2. FORCED
INTO | 3. PART WANTED,
PART FORCED | 8. DK | 9. RF |
|--------------------|-------------------|--------------------------------|-------|-------|

J584 BRANCHPOINT: IF R IS NOT COMPLETELY RETIRED (J578 NOT 1), GO TO J589 BRANCHPOINT

J584

All in all, would you say that your retirement has turned out to be very satisfying, moderately satisfying, or not at all satisfying?

- | | | | | |
|-----------------------|-----------------------------|-----------------------------|-------|-------|
| 1. VERY
SATISFYING | 2. MODERATELY
SATISFYING | 3. NOT AT ALL
SATISFYING | 8. DK | 9. RF |
|-----------------------|-----------------------------|-----------------------------|-------|-------|

J585 BRANCHPOINT: IF R REPORTED {IN CURRENT IW *and* IN THE LAST TWO WAVES} THAT WAS NOT WORKING (J705=1), GO TO J650 (J ASSIST)

J585

Thinking about your retirement years compared to the years just before you retired, would you say the retirement years have been better, about the same, or not as good?

1. BETTER	3. ABOUT THE SAME	5. NOT AS GOOD	6. RETIRED LESS THAN 1 YEAR AGO.	8. DK	9. RF
-----------	-------------------	----------------	----------------------------------	-------	-------

J586 BRANCHPOINT: IF R WAS COMPLETELY RETIRED AT R'S LAST IW (Z134=1) or {R WAS RETIRED and WE DON'T KNOW WHETHER IT WAS COMPLETELY (Z124=1 and {Z134 = EMPTY})}, GO TO J596 BRANCHPOINT

J586

I'm going to read you a list of reasons why some people retire. Please tell me whether, for you, these were very important reasons for retirement, moderately important, somewhat important, or not important at all.

1. CONTINUE	DK	RF
-------------	----	----

J588	1. VERY IMPORTANT	2. MODERATELY IMPORTANT	3. SOMEWHAT IMPORTANT	4. NOT IMPORTANT AT ALL	8. DK	9. RF
J588_1 Poor health. (Was this a very important reason for your retirement, a moderately important reason, somewhat important, or not important at all?)						
J588_2 Wanted to do other things. (Was this a very important reason for your retirement, a moderately important reason, somewhat important, or not important at all?)						

<p>J588_3</p> <p>Didn't like the work.</p> <p>(Was this a very important reason for your retirement, a moderately important reason, somewhat important, or not important at all?)</p>						
<p>J588_4</p> <p>Wanted to spend more time with my family.</p> <p>(Was this a very important reason for your retirement, a moderately important reason, somewhat important, or not important at all?)</p>						

J589 BRANCHPOINT: IF THIS IS A REINTERVIEW R, GO TO J596 BRANCHPOINT

J589

Now I'm going to read you a list of things that some people say are good about retirement.

IF R IS COMPLETELY RETIRED (J578=1):

For each one, please tell me if, during your retirement, it has been very important, moderately important, somewhat important, or not important at all.

OTHERWISE:

For each one, please tell me if, for you, they are very important, moderately important, somewhat important, or not important at all.

1. CONTINUE

DK

RF

J591	1. VERY IMPORTANT	2. MODERATELY IMPORTANT	3. SOMEWHAT IMPORTANT	4. NOT IMPORTANT AT ALL	8. DK	9. RF
J591_1 Being your own boss. ([Has this been/Is this] very important, moderately important, somewhat important, or not important at all?)						
J591_2 Being able to take it easy. ([Has this been/Is this]) very important, moderately important, somewhat important, or not important at all?)						
J591_3 Having the chance to travel. ([Has this been/Is this] very important, moderately important, somewhat important, or not important at all?)						

J592

Now for things that some people say are bad about retirement.

IF R IS COMPLETELY RETIRED (J578=1):

Please tell me if, during your retirement, they have bothered you a lot, somewhat, a little, or not at all.

OTHERWISE:

Please tell me if they worry you a lot, somewhat, a little, or not at all.

1. CONTINUE

DK

RF

NOTE: EACH OF THE THREE WORRIES IN THE TABLE BELOW HAS THE FOLLOWING RETIREMENT CONDITIONS WITH QUESTION FORMS.

IF R IS COMPLETELY RETIRED (J578=1):

Does this bother you a lot, somewhat, a little, or not at all?

IF R IS PARTLY RETIRED (J578=2):

Does this worry you a lot, somewhat, a little, or not at all?

OTHERWISE (J578 {NOT 1 and NOT 2}):

Does this worry you a lot, somewhat, a little, or not at all?

J594	1. A LOT	2. SOMEWHAT	3. A LITTLE	4. NOT AT ALL	7. DIDN'T WORK	8. DK	9. RF
J594_1 Not doing anything productive or useful. (Does this [bother/worry] you a lot, somewhat, a little, or not at all?)							
J594_2 Illness or disability. (Does this [bother/worry] you a lot, somewhat, a little, or not at all?)							
J594_3 Not having enough income to get by. (Does this [bother/worry] you a lot, somewhat, a little, or not at all?)							

J596 BRANCHPOINT: IF THIS IS A NEW INTERVIEW R (Z076 NOT 1), GO TO J650
(J ASSIST)

IF R IS STILL WORKING FOR LAST IW EMPLOYER (J045={1 or 3}),
GO TO J612 BRANCHPOINT

IF R WAS WORKING FOR SOMEONE ELSE LAST IW (Z136=1) and DID
NOT GIVE A {MONTH AND YEAR} THAT S/HE STOPPED WORKING FOR
THAT EMPLOYER ({J063 and J064}={DK or RF}), GO TO J612
BRANCHPOINT

IF R WAS WORKING FOR SOMEONE ELSE LAST IW (Z136=1) and
STARTED WORKING AT CURRENT JOB/BUSINESS (per J248&J256 or
J248&J249) LESS THAN 2 MONTHS FROM WHEN S/HE STOPPED WORKING
FOR LAST IW EMPLOYER (per J063&J064), GO TO J612 BRANCHPOINT

IF R WAS SELF-EMPLOYED AT LAST IW (Z136=2) and DID NOT GIVE
{MONTH AND YEAR} THAT S/HE STOPPED WORKING AT THAT BUSINESS
(J023&J024={DK or RF}), GO TO J612 BRANCHPOINT

IF R WAS {SELF-EMPLOYED AT LAST IW (Z136=2) and IS CURRENTLY
SELF-EMPLOYED (J021=2)} and {{MONTH AND YEAR} STARTED WORKING
FOR CURRENT BUSINESS (per J248&J256 or J248&J249) IS SAME AS
OR BEFORE {MONTH (per Z092) AND YEAR (per Z093)} OF LAST IW
or WE DON'T KNOW (MONTH or YEAR) WHEN R STARTED CURRENT JOB
({J248 or J249}={DK or RF or EMPTY})}}, GO TO J612
BRANCHPOINT

IF {MONTH AND YEAR} R STARTED CURRENT JOB/BUSINESS (per
J248&J256 or J248&J249) IS ON OR BEFORE {MONTH AND YEAR} OF
R's LAST IW or {WE DON'T KNOW (MONTH or YEAR) WHEN R STARTED
CURRENT JOB ({J248 or J249}={DK or RF or EMPTY})} and R IS
WORKING NOW (J020 NOT 5)}, GO TO J612 BRANCHPOINT

IF R WAS SELF-EMPLOYED AT LAST IW (Z136=2) and {MONTH AND
YEAR} R STARTED CURRENT JOB/BUSINESS (per J248&J256 or
J248&J249) IS LESS THAN 2 MONTHS FROM {MONTH AND YEAR} S/HE
STOPPED WORKING FOR SELF (per J023&J024), GO TO J612
BRANCHPOINT

IF R IS CURRENTLY WORKING (J020=1) and DID NOT GIVE {MONTH
AND YEAR} S/HE STARTED CURRENT JOB/BUSINESS (per J248&J256 or
J248&J249), GO TO J612 BRANCHPOINT

*-----Jobs Between Waves-----
(J596-J612)

J596

IF R IS CURRENTLY WORKING (J020=1):
Between ((MONTH, YEAR [R STOPPED WORKING FOR [EMPLOYER (per J063&J064)/SELF (per J023&J024)]/RETIRED (per J017&J018)]/R's LAST IW MONTH, YEAR) and [MONTH, YEAR STARTED WORKING FOR CURRENT [EMPLOYER)/SELF] (per J248&J256 or J248&J249)] did you do any work for pay?

OTHERWISE:

Since ((MONTH, YEAR [R STOPPED WORKING FOR [EMPLOYER (per J063&J064)/SELF (per J023&J024)]/RETIRED (per J017&J018)]/R's LAST IW MONTH, YEAR) did you do any work for pay?

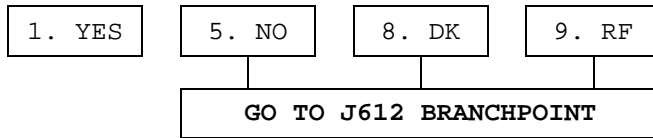

BEGINNING OF JW777_5 LOOP: QUESTIONS JW777_5 AND JW778_5 ARE REPEATED FOR UP TO FOUR ELIGIBLE YEARS.

NOTE: ELIGIBLE YEARS ARE 2013 AND 2012, THE YEARS IN WHICH THERE COULD BE IWS FOR THIS HRS WAVE, AND 2011 & 2010, THE YEARS IN WHICH THERE WERE IWS FOR Rs IN THE PREVIOUS HRS WAVE. INDIVIDUAL Rs WILL BE ASKED QUESTIONS THAT APPLY ONLY TO THE YEARS THAT SPAN THE RANGE FOR THAT R's TWO INTERVIEWS, BEGINNING WITH THE MOST RECENT YEAR AND ENDING WITH THE YEAR OF THE PRIOR IW, OR 2010 IF THE R WAS NOT INTERVIEWED IN THE PREVIOUS HRS WAVE.

JW777_5 BRANCHPOINT: IF YEARS R REPORTED WORKED FOR PAY (per J596) ARE NOT IN ELIGIBLE YEAR RANGE, GO TO JW786_5 BRANCHPOINT

IF THE FIRST AND LAST YEARS IN RANGE ARE THE SAME (per J596), GO TO JW778_5 BRANCHPOINT

JW777_5

Were there any months in ELIGIBLE YEAR when you did any work for pay?

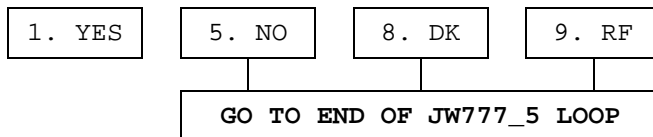

JW778_5 BRANCHPOINT: IF THERE IS ONLY ONE ELIGIBLE MONTH ON MONTHLIST, ASSIGN THAT MONTH TO JW778_5 AND GO TO THE END OF JW777_5 LOOP

JW778_5

Which months in *ELIGIBLE YEAR* were those (when you did any work for pay)?

[IWER: CHOOSE ALL THAT APPLY]

[IWER: ONLY ELIGIBLE MONTHS WILL APPEAR ON THE LIST]

[IWER: YOU MUST ENTER MONTH(S) FOR THIS QUESTION. IF YOU HAVE GOTTEN THIS QUESTION IN ERROR, BACK UP AND CHANGE ANSWER TO PREVIOUS QUESTION TO 'NO']

1. JAN	2. FEB	3. MAR	4. APR	5. MAY	6. JUN	7. JUL
8. AUG	9. SEP	10. OCT	11. NOV	12. DEC	13. ALL	
14. ALL MONTHS DISPLAYED	15. ALL MONTHS DISPLAYED	98. DK	99. RF			

NOTE: THE ONLY MONTHS AND YEARS PRESENTED TO THE IWER ARE THOSE FROM R'S LAST IW UNTIL THE DATE R STOPPED WORKING FOR THAT EMPLOYER/BUSINESS. CODES 13, 14, AND 15 ARE NOT SHOWN IN THE DATA AND SHOULD NOT BE USED FOR ANALYSIS PURPOSES. THEY WILL ONLY SHOW IN THE CODEFRAME AS A CONVENIENCE FOR INTERVIEWERS WHEN APPROPRIATE.

END OF JW777_5 LOOP: QUESTIONS JW777_5 AND JW778_5 ARE REPEATED FOR UP TO FOUR ELIGIBLE YEARS. OTHERWISE, CONTINUE

JW786_5 BRANCHPOINT: IF YEAR R STOPPED WORKING/RETIRED IS THE SAME YEAR or AFTER THE PREVIOUS HRS WAVE YEAR, GO TO J599

JW786_5

Were there any months between *MONTH, YEAR R [STOPPED WORKING FOR [EMPLOYER (per J063&J064)/SELF (per J023&J024)]/RETIRED {per J017&J018}]* /R'S LAST IW MONTH, YEAR] and January [FIRST YEAR OF PREVIOUS HRS WAVE DATA COLLECTION] when you did any work for pay?

1. YES	5. NO	8. DK	9. RF
--------	-------	-------	-------

J599

During these months, how many hours per week did you usually work?

HOURS

DK

RF

J600

On average, how much were you earning before deductions during these months?

[IWER: IF AMOUNT PER HOUR, ENTER BOTH DOLLARS AND CENTS]

[IWER: DO NOT PROBE DK/RF]

0

DK

RF

AMOUNT

|

GO TO J604

|

GO TO J606

J601-J603 Unfolding Sequence

Question text: Did it amount to a total of \$_____ per month, more than \$_____ per month, or what?

PROCEDURES: 2Up1Down, 1Up2Down

BREAKPOINTS: \$250, **\$750**, **\$1,500**, \$4,000

RANDOM ENTRY POINTS: \$750, \$1,500

ENTRY POINT ASSIGNMENT: 1 OR {NOT 1} AT X505

ORDER OF ENTRY POINT ASSIGNMENTS AND PROCEDURES CORRESPOND

J604 BRANCHPOINT: GO TO J606

J604

[IWER: PROBE IF NECESSARY]

Was that per hour, week, month, or year?

PER:

1. HOUR

2. WEEK

3. EVERY TWO WEEKS/BI-WEEKLY

4. MONTH

5. TWICE A MONTH

6. YEAR

7. OTHER (SPECIFY)

J605

8. DK

9. RF

J606

Counting yourself as an employer if you were self employed, for how many employers did you work during those months?

1. ONE	2. TWO OR MORE	8. DK	9. RF
--------	----------------	-------	-------

GO TO J612 BRANCHPOINT

J607

Why did you stop working at that job? (Did the business close, were you laid off or let go, did you leave to take care of family members or what?)

[IWER: CHOOSE ALL THAT APPLY]

1. BUSINESS CLOSED	2. LAID OFF/LET GO	3. POOR HEALTH/DISABLED	4. FAMILY CARE	5. BETTER JOB
--------------------	--------------------	-------------------------	----------------	---------------

GO TO J612 BRANCHPOINT

6. QUIT	7. RETIRED	97. OTHER (SPECIFY) _____	98. DK	99. RF
---------	------------	------------------------------	--------	--------

J608

J609

Did your employment situation change in some way that encouraged you to leave?

1. YES	5. NO	8. DK	9. RF
--------	-------	-------	-------

GO TO J612 BRANCHPOINT

J610

How did it change?

[IWER: CHOOSE ALL THAT APPLY]

1. SUPERVISOR
ENCOURAGED
DEPARTURE

2. COWORKER
ENCOURAGED
DEPARTURE

3. WAGES
REDUCED (OR
ABOUT TO BE
REDUCED)

4. HOURS REDUCED
(OR ABOUT TO BE
REDUCED)

5. WOULD HAVE
BEEN LAID OFF

6. NEW JOB
DUTIES

7. NEW JOB
LOCATION

8. BECAME ELIGIBLE
FOR PENSION

9. EMPLOYER
CHANGED HEALTH
INSURANCE

10. SPECIAL
EARLY RETIREMENT
INCENTIVE OFFER

97. OTHER
(SPECIFY)

98. DK

99. RF

J611

J612 BRANCHPOINT: IF R DID NOT REPORT THAT IS CURRENTLY WORKING (J020={5 or DK or RF}) and DID NOT REPORT AT R's LAST IW THAT WAS WORKING FOR PAY (Z123 NOT 1) and DID NOT REPORT THAT HAS WORKED FOR PAY BETWEEN {LEAVING LAST IW EMPLOYER AND {THE PRESENT OR START OF CURRENT EMPLOYMENT}} (J596={5 or DK or RF}), GO TO J650 (J ASSIST)

IF R IS NOT WORKING (J020=5) and STOPPED WORKING MORE THAN A YEAR AGO (per {J063&J064 or J023&J024 or J017&J018}) and R DID NOT SAY THAT WORKED SINCE STOPPED (J596={5 or 8 or 9}), GO TO J613 BRANCHPOINT

J612

Counting paid vacations as weeks of work, how many weeks did you work in the last 12 months?

[IWER: COUNT PAID SICK TIME AS WORK TIME]

[IWER: THIS REFERS TO WEEKS WORKED IN LAST 12 MONTHS ON CURRENT JOB]

DK

RF

WEEKS

J613 BRANCHPOINT: IF R {REPORTED IN CURRENT IW THAT HAD MARGINAL EMPLOYMENT and REPORTED IN LAST IW THAT HAD {MARGINAL EMPLOYMENT OR NONE}} (J703=1), GO TO J650 (J ASSIST)

IF R IS SELF-EMPLOYED NOW (J021=2) and WAS SELF-EMPLOYED AT R's LAST IW (Z136=2), GO TO J650 (J ASSIST)

IF R WAS SELF-EMPLOYED AT R's LAST IW (Z136=2) and DID NOT REPORT THAT IS CURRENTLY WORKING (J020 NOT 1) and DID NOT REPORT THAT HAS WORKED FOR PAY BETWEEN {LAST IW AND START OF CURRENT EMPLOYMENT} (J596={5 or DK or RF}), GO TO J650 (J ASSIST)

IF R DID NOT REPORT AT R's LAST IW THAT WAS WORKING FOR PAY (Z123 NOT 1) and IS SELF-EMPLOYED NOW (J021=2) and DID NOT REPORT THAT HAS WORKED FOR PAY BETWEEN {LAST IW AND START OF CURRENT EMPLOYMENT} (J596={5 or DK or RF}), GO TO J650 (J ASSIST)

*-----Early Out Retirement Incentives-----
(J613-J650)

J613

Employers sometimes encourage older workers to leave a firm at a particular time by offering a special financial incentive, like a cash bonus or improved pension benefits. These are often called 'early retirement windows.'

Have you been offered such an early retirement window at any time since R's LAST IW MONTH, YEAR?

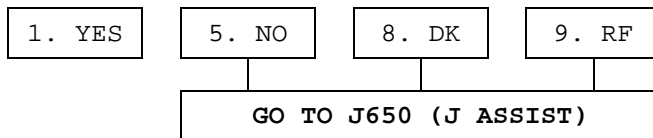

J614

How many of these special incentive offers have you received [since R's LAST IW MONTH, YEAR/in the last two years]?

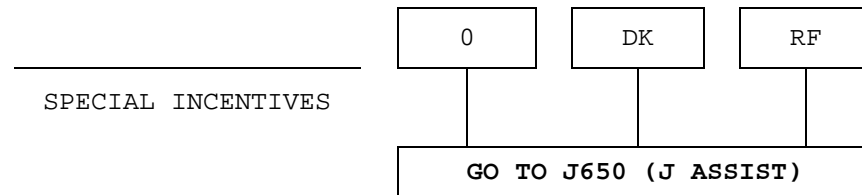

HRS 2012 — SECTION J: EMPLOYMENT — PAGE 90

FINAL VERSION — 11/05/2012

BEGINNING OF J616 LOOP: QUESTIONS J616 THROUGH J646 ARE REPEATED FOR THE FIRST AND LAST SPECIAL INCENTIVES THE R RECEIVED.

J616

In what month and year was the (first/last) special incentive offered?

[IWER: MONTH ENTERED MUST BE BETWEEN [NOV. YEAR 2 YEARS AGO/REINTERVIEW R'S LAST IW MONTH, YEAR] AND CURRENT IW MONTH, YEAR]

J616

MONTH:

1. JAN	2. FEB	3. MAR	4. APR	5. MAY	6. JUN	7. JUL
8. AUG	9. SEP	10. OCT	11. NOV	12. DEC	98. DK	99. RF

DK	RF
----	----

J617
YEAR

J619 BRANCHPOINT: IF R IS STILL WORKING FOR LAST IW EMPLOYER (J045={1 or 3}), GO TO J621

J619

Which employer were you working for at the time?

[IWER: SELECT EMPLOYER FROM LIST BELOW]

[IWER: IF EMPLOYER NOT LISTED, SELECT OTHER, SPECIFY AND ENTER FULL NAME OF EMPLOYER ON NEXT SCREEN]

1. LAST WAVE EMPLOYER NAME (per A508)	2. CURRENT EMPLOYER NAME (per JW158)	7. OTHER (SPECIFY) _____ J620	8. DK	9. RF
---	--	-------------------------------------	-------	-------

J621

Was the special incentive a cash bonus, improved pension benefits or what?

[IWER: CHOOSE ALL THAT APPLY]

1. CASH BONUS	2. IMPROVED PENSION BENEFITS	3. PERMANENT MEDICAL INSURANCE	4. TEMPORARY MEDICAL INSURANCE
5. TEMPORARY CASH BENEFIT	6. ADDITIONAL YEARS OF SERVICE CREDITED	7. OTHER (SPECIFY) J622	8. DK
			9. RF

J623 BRANCHPOINT: IF R's OFFER DID NOT INCLUDE A CASH BONUS (J621 NOT 1), GO TO J627 BRANCHPOINT

J623

How much did the cash bonus offer amount to?

[IWER: DO NOT PROBE DK/RF]

AMOUNT

DK	RF
----	----

GO TO J627
BRANCHPOINT

J624-J626 Unfolding Sequence

Question text: Did it amount to less than \$____ , more than \$____ , or what?

PROCEDURES: 2Up1Down, 1Up2Down
 BREAKPOINTS: \$15,000, **\$25,000**, **\$50,000**, \$75,000
 RANDOM ENTRY POINTS: \$25,000, \$50,000
 ENTRY POINT ASSIGNMENT: 1 OR {NOT 1} AT X506
 ORDER OF ENTRY POINT ASSIGNMENTS AND PROCEDURES CORRESPOND

J627 BRANCHPOINT: IF R's OFFER DID NOT INCLUDE IMPROVED PENSION BENEFIT (J621 NOT 2), GO TO J633 BRANCHPOINT

J627

How much did the extra pension benefit offer amount to?

[IWER: DO NOT PROBE DK/RF]

[IWER: IF AMOUNT PER HOUR, ENTER BOTH DOLLARS AND CENTS]

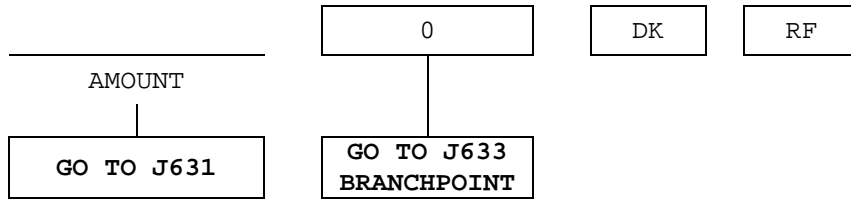

J628-J630 unfolding sequence

Question text: Did it amount to less than \$____ , more than \$____ , or what?

PROCEDURES: 2Up1Down, 1Up2Down

BREAKPOINTS: \$3,000, \$5,000, \$12,000, \$36,000

RANDOM ENTRY POINTS: \$5,000, \$12,000

ENTRY POINT ASSIGNMENT: 1 OR {NOT 1} AT X507

ORDER OF ENTRY POINT ASSIGNMENTS AND PROCEDURES CORRESPOND

J631 BRANCHPOINT: GO TO J633 BRANCHPOINT

J631

[IWER: PROBE IF NECESSARY]

Was that per week, month, year, or a lump sum?

PER:

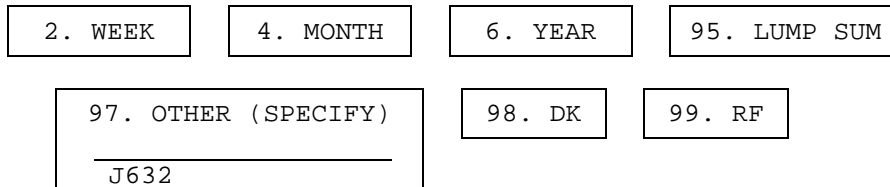

J633 BRANCHPOINT: IF R's OFFER DID NOT INCLUDE TEMPORARY MEDICAL INSURANCE (J621 NOT 4), GO TO J636 BRANCHPOINT

J633

Until what age was the temporary medical insurance offered?

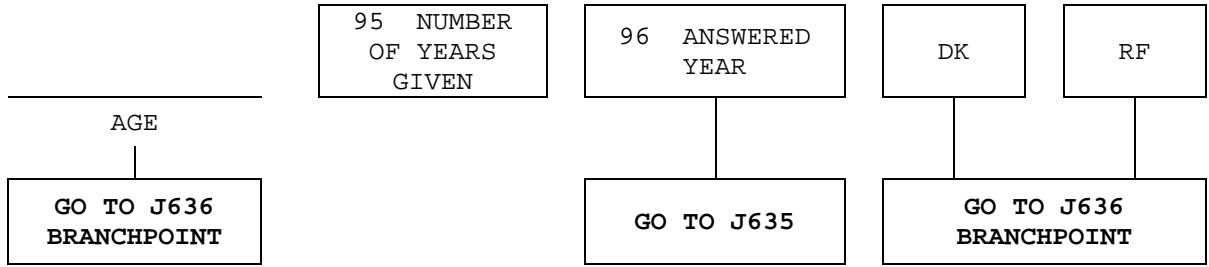

J634

[IWER: PROBE IF NECESSARY]

For how many years was the temporary medical insurance offered?

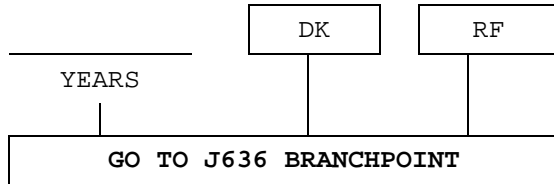

J635

[IWER: PROBE IF NECESSARY]

Until which year was the temporary medical insurance offered?

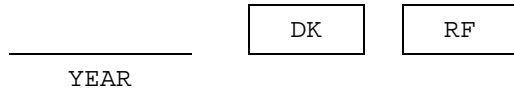

J636 BRANCHPOINT: IF R'S OFFER DID NOT INCLUDE TEMPORARY CASH BENEFITS (J621 NOT 5), GO TO J642 BRANCHPOINT

J636

How much did the temporary cash benefits offer amount to?

AMOUNT

0	DK	RF
---	----	----

GO TO J639

J637

[IWER: PROBE IF NECESSARY]

Was that per week, month year, or a lump sum?

PER:

2. WEEK	4. MONTH	6. YEAR	95. LUMP SUM
---------	----------	---------	--------------

97. OTHER (SPECIFY) _____ J638	98. DK	99. RF
--------------------------------------	--------	--------

J639

Until what age was the temporary cash benefit offered?

AGE

95 NUMBER OF YEARS GIVEN	96 ANSWERED YEAR	DK	RF
--------------------------	------------------	----	----

GO TO J642 BRANCHPOINT

GO TO J641

GO TO J642 BRANCHPOINT

J640

[IWER: PROBE IF NECESSARY]

For how many years was the temporary cash benefit offered?

YEARS

DK	RF
----	----

GO TO J642 BRANCHPOINT

J641

[IWER: PROBE IF NECESSARY]

Until which year was the temporary cash benefit offered?

YEAR

DK	RF
----	----

J642 BRANCHPOINT: IF R'S OFFER DID NOT INCLUDE ADDITIONAL YEARS OF SERVICE CREDIT (J621 NOT 6), GO TO J643 BRANCHPOINT

J642

How many years of service credit were you offered?

YEARS

J643 BRANCHPOINT: IF R'S OFFER DID NOT INCLUDE OTHER INCENTIVES (J621 NOT 7), GO TO J644

J643

IF R MENTIONS OTHER INCENTIVES ONLY (J621=7 ONLY):
Altogether, how much did the incentive offer amount to?

OTHERWISE:

(Not including [the cash bonus, /(and) improved pension benefits, /(and) permanent medical insurance, /(and) temporary medical insurance, /(and) temporary cash benefit, /(and) additional years of service credited,]) what was the value of the other part of the (first/second) incentive offer?

NOTE: "and" IS INSERTED BETWEEN THE LAST ITEM ON THE LIST AND ITS PREDECESSOR.

AMOUNT

NOTE: ALL TYPES OF INCENTIVES SELECTED AT J621 ARE INCLUDED IN THE QUESTION TEXT.

J644

Did you accept the incentive and leave that employer?

GO TO J646

J645

Was the special incentive important in your decision, or would you probably have left at about that time anyway?

GO TO END OF J616 LOOP (AFTER J646)

J646

If you had been offered twice as much (to leave) at that time, would you have done so?

1. YES

5. NO

8. DK

9. RF

****END OF J616 LOOP: REPEAT QUESTIONS J616 THROUGH J646 IF MORE THAN ONE EARLY OUT WINDOW WAS OFFERED. IF NOT, CONTINUE ON TO J650.****

J650

J ASSIST

IWER: HOW OFTEN DID R RECEIVE ASSISTANCE WITH ANSWERS IN SECTION J — EMPLOYMENT?

1. NEVER

2. A FEW TIMES

3. MOST OR ALL
OF THE TIME

4. THE SECTION WAS DONE
BY A PROXY REPORTER

GO TO SECTION J2