

\*\*\*\*\*

**NOTE ABOUT BRANCHPOINTS:**

WHERE THERE IS MORE THAN ONE JUMP WITHIN A BRANCHPOINT BOX, THE JUMPS ARE TO BE APPLIED IN ORDER FROM THE TOP.

\*\*\*\*\*

**NOTE ABOUT COLORS:**

ALL QUESTION TEXT IN BLACK IS FOR THE CORE INTERVIEW.

ALL QUESTION TEXT IN FUCHSIA IS FOR THE EXIT INTERVIEW. ALSO IN FUCHSIA IS ALL OTHER TEXT THAT IS SPECIFIC TO THE EXIT INTERVIEW BUT NOT TO THE CORE.

OTHERWISE, BLACK TEXT FOR CODEFRAMES, INTERVIEWER INSTRUCTIONS, JUMPS AND BRANCHPOINTS, ETC. CAN APPLY TO BOTH THE CORE AND THE EXIT INTERVIEW UNLESS SPECIFIED OTHERWISE OR THERE IS AN EXIT ALTERNATIVE.

ON A BLACK-AND-WHITE HARD COPY OF THE DOCUMENT, THE FUCHSIA TEXT WILL APPEAR SOMEWHAT LIGHTER THAN THE ORIGINAL BLACK.

\*\*\*\*\*

**NOTE ABOUT EXIT INTERVIEW Rs:**

ANY NEW SPOUSE/PARTNER THAT AN EXIT INTERVIEW R ACQUIRED SINCE HIS/HER LAST INTERVIEW IS IGNORED FOR THE PURPOSES OF THIS INTERVIEW.

\*\*\*\*\*

**MAJOR FLOW CONTROL, CONDITION AND FILL VARIABLES \***

THIS IS A NEW EXIT R (HAS NEVER BEFORE BEEN INTERVIEWED AS AN EXIT R: = {R DIED SINCE LAST IW or {R WAS REPORTED DEAD AT A PREVIOUS IW BUT EXIT IW HAS NEVER BEEN DONE FOR THIS R = NOT A POST-EXIT IW}}) (A007=5 and {Z145 {NOT 1 and NOT 2 and NOT 3 and NOT 4}})

THIS IS A NEW POST-EXIT INTERVIEW (Z145=2);  
THIS IS A FIRST REPEAT POST-EXIT INTERVIEW (Z145=3);  
THIS IS A SECOND REPEAT POST-EXIT INTERVIEW (Z145=4)

THIS IS A SELF INTERVIEW (A009=1);  
THIS IS A PROXY INTERVIEW (A009={2 or 3}) or (A009 NOT 1);  
PROXY REPORTER IS SURVIVING SPOUSE (A009=2);  
PROXY REPORTER IS NON-SPOUSE (A009=3)

R IS MARRIED (X065=1);  
R IS PARTNERED (X065=3);  
R IS OTHER (SINGLE) (X065=6)

R WAS MARRIED AT HH's LAST IW (Preload\_X065=1);  
R WAS NOT COUPLED AT HH's LAST IW (Preload\_X065 {NOT 1 and NOT 3})

R WAS PARTNERED AT HH's LAST IW (Preload\_X065=3);  
R WAS SINGLE AT HH's LAST IW (Preload\_X065=6)

R WAS MARRIED WHEN S/HE DIED (A026=1)

R's LAST IW SPOUSE/PARTNER WAS LIVING WHEN S/HE DIED (A023=1);  
R's LAST IW SPOUSE/PARTNER WAS NOT LIVING WHEN S/HE DIED (A023=5)

R's FIRST NAME (per X058)

HH's LAST IW MAIN RESIDENCE CITY (per X025), STATE (STATE ABBREVIATION)  
(per X026);  
HH's LAST IW 2ND RESIDENCE CITY (per X029), STATE (STATE ABBREVIATION)  
(per X030)

R's LAST IW MONTH (per Z092), YEAR (per Z093)

FINANCIAL R's LAST IW MONTH (per X038), YEAR (per X039)

NUMBER OF CHILDREN OR STEP-CHILDREN (per A101);  
R HAS NO CHILDREN (A101=0)

FOR FAMILY R, NUMBER OF GRANDCHILDREN FOR CORE OR EXIT R (NOT POST-EXIT R)  
(per E046);  
FOR FAMILY R, NUMBER OF GRANDCHILDREN NOT ASKED BECAUSE ASSUMED TO BE ZERO  
(E046=95);  
FAMILY R HAS NO GRANDCHILDREN (E046 NOT {>0 - <81})

FOR NON-FAMILY R, NUMBER OF GRANDCHILDREN (per Z114)

R OWNED A MAIN RESIDENCE OR {MOBILE {HOME AND/OR SITE}} OR FARM AT R's LAST IW  
(X079=1)

R OWNED SECOND RESIDENCE AT HH's LAST IW (X032 = 1)

ASK ABOUT DISPOSITION OF HOME ONLY (Z146=1);  
ASK ABOUT WILL/TRUST ONLY (Z146=2);  
ASK ABOUT BOTH HOME AND WILL/TRUST (Z146=3)

-----  
\* A variable fieldname and code reference is shown at its first occurrence  
in the questionnaire, but in some cases, especially when it is common,  
is not shown after that.

\*\*\*\*\*

T001 BRANCHPOINT: IF THIS IS AN EXIT INTERVIEW, GO TO T101 BRANCHPOINT

**!! WILLS--FAMILY**

T001

Do you currently have a will that is written and witnessed?

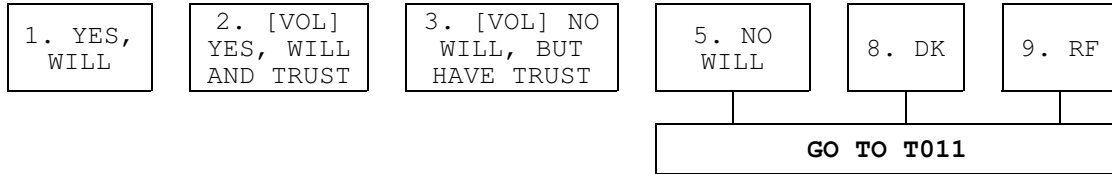

T002

Have you made provisions in your [will/will or trust/trust] for any family members other than your [husband/wife/partner]?

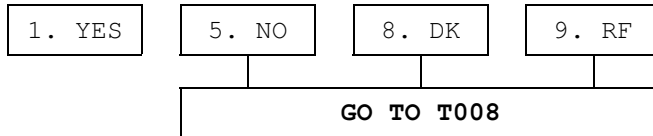

T003 BRANCHPOINT: IF R DOES NOT HAVE CHILDREN OR STEP-CHILDREN (A101=0), GO TO T006 BRANCHPOINT

T003

Does that include any of your children or step-children?

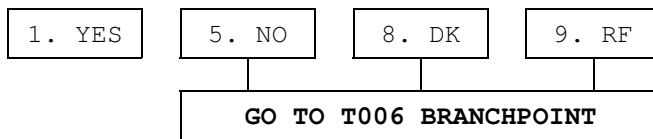

T004/T050\_T004

(Which child is that?)

[IWER: CHOOSE ALL THAT APPLY. IF ONLY ONE CHILD APPEARS, SELECT AND MOVE ON.]

CHILD NAME(S) [DISPLAYED BY BLAISE FROM PREVIOUS RESPONSES]
3. THROUGH 52. CHILD NAME(S)
[ROWS PROVIDED BY BLAISE AS NECESSARY]
93. ALL CHILDREN EQUALLY
96. ALL CHILDREN — "EQUALLY" NOT MENTIONED
98. DK
99. RF

NOTE: NAMES OF ALL LIVING AND DEAD CHILDREN ARE DISPLAYED. NAMES OF SPOUSE/PARTNERS OF CHILDREN ARE NOT DISPLAYED.

T005 BRANCHPOINT: IF R REPORTED THAT MADE PROVISION FOR ALL CHILDREN EQUALLY (T004=93), GO TO T006 BRANCHPOINT

IF IWER MADE ONLY 1 SELECTION AT T004 and SELECTION AT T004 WAS NOT 96 ('ALL CHILDREN — "EQUALLY" NOT MENTIONED'), GO TO T006 BRANCHPOINT

T005

Does that document provide for all your children about equally?

1. YES	5. NO	8. DK	9. RF
--------	-------	-------	-------

T006 BRANCHPOINT: IF {THIS IS A FAMILY R WHO DID NOT REPORT THAT HAD GRANDCHILDREN (E046 NOT {>0 - <81}) or THIS IS A NON-FAMILY R WHO WAS NOT REPORTED IN A PREVIOUS WAVE TO HAVE GRANDCHILDREN (Z114 NOT {>0 - <81})}, GO TO T008

T006

Does that document include any grandchild directly?

1. YES	2. [VOL] ONLY THROUGH THEIR PARENTS	5. NO	8. DK	9. RF
GO TO T008				

T007/T051\_T007

(Which of your children is the parent of that grandchild?)

[IWER: CHOOSE ALL THAT APPLY]

CHILD NAME(S) [DISPLAYED BY BLAISE FROM PREVIOUS RESPONSES]
3. THROUGH 52. CHILD NAME(S) [ROWS PROVIDED BY BLAISE AS NECESSARY]
92. DECEASED CHILD
93. ALL CHILDREN
98. DK
99. RF

NOTE: NAMES OF ALL LIVING AND DEAD CHILDREN ARE DISPLAYED. NAMES OF SPOUSE/PARTNERS OF CHILDREN ARE NOT DISPLAYED.

T008

Have you made provisions for any charities in your will or trust?

1. YES	5. NO	8. DK	9. RF
--------	-------	-------	-------

**!! LIFE INSURANCE**

T011

Do you have any life insurance, including individual or group policies?

[IWER: DO NOT INCLUDE BURIAL INSURANCE]

1. YES	5. NO	8. DK	9. RF
GO TO T036			

T012

How many different life insurance policies do you have?

[IWER: INCLUDE INDIVIDUAL POLICIES, GROUP POLICIES, OR PAID-UP POLICIES IF R ASKS]

1. ONE	2. TWO	3. THREE	4. FOUR	5. FIVE OR MORE	8. DK	9. RF
--------	--------	----------	---------	-----------------	-------	-------

T013

IF R HAS ONLY ONE LIFE INSURANCE POLICY (T012=1):  
 What is the total face value of this policy, that is, the amount of money the beneficiary would get if you were to die?

OTHERWISE:

Altogether, what is the total face value of these policies, that is, the amount of money the beneficiary would get if you were to die?

[IWER: DO NOT PROBE DK/RF]

	DK	RF
AMOUNT		
<b>GO TO T017</b>		

T014-T016 Unfolding Sequence

Question text: Does it amount to less than \$\_\_\_\_ , more than \$\_\_\_\_ , or what?

PROCEDURES: 3Up, 2Up1Down, 1Up2Down

BREAKPOINTS: **\$2,500, \$25,000, \$50,000, \$250,000**

RANDOM ENTRY POINTS: \$2,500, \$25,000, \$50,000

ENTRY POINT ASSIGNMENT 1 or 2 or {NOT 1 and NOT 2} AT Z087

ORDER OF ENTRY POINT ASSIGNMENTS AND PROCEDURES CORRESPOND

T017/T052\_T017

IF R HAS ONLY ONE LIFE INSURANCE POLICY (T012=1):  
 Who are the beneficiaries of this policy?

OTHERWISE:

Who are the beneficiaries of these policies?

[IWER: CHOOSE ALL THAT APPLY]

CHILD NAME(S) [DISPLAYED BY BLAISE FROM PREVIOUS RESPONSES]
3. THROUGH 52. CHILD NAME(S)
[ROWS PROVIDED BY BLAISE AS NECESSARY]
91. R'S SPOUSE/PARTNER
92. DECEASED CHILD
93. ALL CHILDREN
94. ALL GRANDCHILDREN
97. OTHER (SPECIFY) [T045]
98. DK
99. RF

NOTE: NAMES OF ALL LIVING AND DEAD CHILDREN ARE DISPLAYED. NAMES OF SPOUSE/PARTNERS OF CHILDREN ARE NOT DISPLAYED.

T018

[Is this a life insurance policy that builds/Are any of these life insurance policies ones that build] up a cash value that you can borrow against, or that you would receive if the policy were to be cancelled?

DEFINITION: THESE ARE SOMETIMES CALLED 'WHOLE LIFE' OR 'STRAIGHT LIFE POLICIES.'

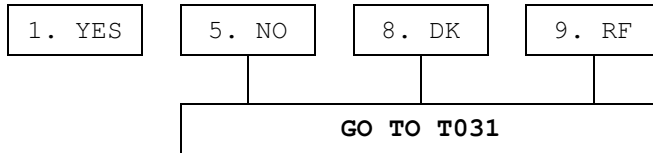

T019 BRANCHPOINT: IF R HAS ONLY ONE LIFE INSURANCE POLICY (T012=1), GO TO T024

T019

(How many such policies do you have?)

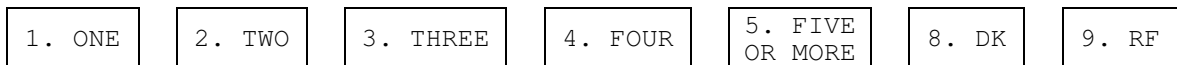

T020

What is the current face value of [these policies/this policy]?

[IWER: DO NOT PROBE DK/RF]

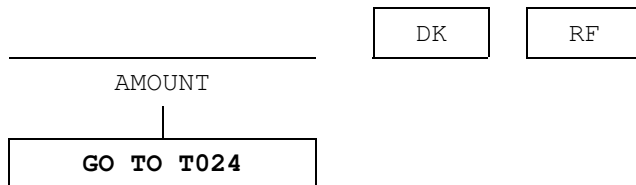

T021-T023 Unfolding Sequence

Question text: Does it amount to less than \$\_\_\_\_ , more than \$\_\_\_\_ , or what?

PROCEDURES: 3Up, 2Up1Down, 1Up2Down

BREAKPOINTS: **\$2,500, \$25,000, \$50,000, \$250,000**

RANDOM ENTRY POINTS: \$2,500, \$25,000, \$50,000

ENTRY POINT ASSIGNMENT 1 or 2 or {NOT 1 and NOT 2} AT Z087

ORDER OF ENTRY POINT ASSIGNMENTS AND PROCEDURES CORRESPOND

T024

IF R HAS ONLY ONE LIFE INSURANCE POLICY (T019=1):  
 (Altogether,) about how much in total do you pay for this policy each  
 month or year?

OTHERWISE:  
 (Altogether,) about how much in total do you pay for these policies each  
 month or year?

[IWER: ENTER 0 IF PAID UP OR NO PREMIUM PAYMENTS]

	0 NO PREMIUM PAYMENTS	DK	RF
AMOUNT			
GO TO T025	GO TO T029 BRANCHPOINT		

T026-T028 Unfolding Sequence

Question text: Does it amount to less than \$\_\_\_\_ per month, more than  
 \$\_\_\_\_ per month, or what?

PROCEDURES: 2Up2Down, 1Up3Down  
 BREAKPOINTS: \$20, \$50, **\$100**, **\$200**, \$400  
 RANDOM ENTRY POINTS: \$100, \$200  
 ENTRY POINT ASSIGNMENT 1 or {NOT 1} AT X501  
 ORDER OF ENTRY POINT ASSIGNMENTS AND PROCEDURES CORRESPOND

T025

PER:

1. MONTH	2. YEAR	8. DK	9. RF
----------	---------	-------	-------

T029 BRANCHPOINT: IF R HAS ONLY ONE LIFE INSURANCE POLICY (T012=1), GO TO T031



T029/T053\_T029

IF R HAS ONLY ONE LIFE INSURANCE POLICY (T019=1):  
Who are the beneficiaries of this policy?

OTHERWISE:  
Who are the beneficiaries of these policies?

[IWER: CHOOSE ALL THAT APPLY]

CHILD NAME(S) [DISPLAYED BY BLAISE FROM PREVIOUS RESPONSES]
3. THROUGH 52. CHILD NAME(S) [ROWS PROVIDED BY BLAISE AS NECESSARY]
91. R'S SPOUSE/PARTNER
92. DECEASED CHILD
93. ALL CHILDREN
94. ALL GRANDCHILDREN
97. OTHER (SPECIFY) [T030]
98. DK
99. RF

NOTE: NAMES OF ALL LIVING AND DEAD CHILDREN ARE DISPLAYED. NAMES OF SPOUSE/PARTNERS OF CHILDREN ARE NOT DISPLAYED.

**!! NEW LIFE INSURANCE**

T031

[Since R's LAST IW MONTH, YEAR/In the last 2 years], have you obtained any new life insurance policies?

1. YES	5. NO	8. DK	9. RF
GO TO T036			

T032

What is the total face value of (this policy/all of these policies)?

[IWER: DO NOT PROBE DK/RF]

\_\_\_\_\_

AMOUNT

|

DK	RF
----	----

|

<b>GO TO T036</b>
-------------------

T033-T035 Unfolding Sequence

Question text: Does it amount to less than \$\_\_\_\_ , more than \$\_\_\_\_ , or what?

PROCEDURE: 2Up1Down

BREAKPOINTS: \$2,500, **\$25,000**, \$50,000, \$250,000

ENTRY POINT: \$25,000

**!! LAPSED LIFE INSURANCE**

T036

[Since R's LAST IW MONTH, YEAR/In the last 2 years], have you allowed any life insurance policies to lapse or have any been cancelled?

1. YES	5. NO	8. DK	9. RF
--------	-------	-------	-------

|

<b>GO TO T047 (T ASSIST)</b>
------------------------------

T037

What was the total face value of (this policy/all of these policies)?

[IWER: DO NOT PROBE DK/RF]

\_\_\_\_\_

AMOUNT

|

DK	RF
----	----

|

<b>GO TO T041</b>
-------------------

T038-T040 Unfolding Sequence

Question text: Does it amount to less than \$\_\_\_\_ , more than \$\_\_\_\_ , or what?

PROCEDURE: 1Up2Down

BREAKPOINTS: \$2,500, \$25,000, **\$50,000**, \$250,000

ENTRY POINT: \$50,000

T041

Was this lapse or cancellation something you chose to do, or was it done by the provider, your employer, or someone else?

1. R'S CHOICE	2. PROVIDER/EMPLOYER/ SOMEONE ELSE CHOSE	8. DK	9. RF
---------------	---	-------	-------

GO TO T047 (T ASSIST)

T042

Was it because the policy was too expensive, because you did not need the coverage or some other reason?

1. TOO EXPENSIVE	2. COVERAGE NOT NEEDED	3. R GOT NEW POLICY
4. TAKE THE CASH OUT	7. OTHER (SPECIFY) _____ T048 (Tag#=T042.5)	8. DK      9. RF

T043

Did you receive any cash when the policy was cancelled or allowed to lapse?

1. YES	5. NO	8. DK	9. RF
--------	-------	-------	-------

GO TO T047 (T ASSIST)

T044

About how much cash did you receive?

\_\_\_\_\_

AMOUNT

DK	RF
----	----

T047

T ASSIST  
IWER: HOW OFTEN DID R RECEIVE ASSISTANCE WITH ANSWERS IN SECTION T — WILLS AND TRUSTS?

1. NEVER	2. A FEW TIMES	3. MOST OR ALL OF THE TIME	4. THE SECTION WAS DONE BY A PROXY REPORTER
----------	----------------	-------------------------------	--

!! EXIT 1<sup>st</sup> HOME DISPOSAL - FIRST RESIDENCE

T101 BRANCHPOINT: IF THIS IS NOT AN EXIT INTERVIEW, GO TO SECTION U

IF THIS IS A POST-EXIT INTERVIEW (Z145={2 or 3 or 4}) and WE DON'T NEED TO ASK ABOUT THE HOME DISPOSITION (Z146 {NOT 1 and NOT 3}), GO TO T155 BRANCHPOINT

IF THIS IS NOT A POST-EXIT IW (Z145 {NOT 2 and NOT 3 and NOT 4}) and R DID NOT OWN RESIDENCE/MOBILE HOME/FARM IN HH'S LAST IW (X079 NOT 1), GO TO T124 BRANCHPOINT

T101

IF {R's LAST IW SPOUSE/PARTNER WAS NOT LIVING WHEN S/HE DIED (A023 NOT 1) and PROXY IS NOT A SURVIVING SPOUSE/PARTNER (A009 NOT 2)} or R {WAS REMARRIED WHEN S/HE DIED (A026=1) and WAS NOT COUPLED AT HH'S LAST IW (Preload\_X065 {NOT 1 and NOT 3}):

Our records show that R's FIRST NAME (per X058) owned a home in HH's LAST IW 1ST RESIDENCE CITY (X025), STATE (STATE ABBREVIATION) (X026) in [FINANCIAL R's LAST IW [MONTH (per X038), ]YEAR (per X038)/the last two years].

IF R WAS MARRIED/PARTNERED HH'S LAST IW (Preload\_X065={1 or 3}) and PROXY IS R'S SURVIVING SPOUSE/PARTNER (A009=2):

Our records show that you and R's FIRST NAME owned a home in HH's LAST IW 1ST RESIDENCE CITY, STATE (STATE ABBREVIATION) in [FINANCIAL R's LAST IW [MONTH, ]YEAR/the last two years].

OTHERWISE, IF {THIS IS NOT A POST-EXIT AND R'S LAST IW SPOUSE/PARTNER WAS LIVING WHEN S/HE DIED (A023=1) and PROXY IS NOT A SURVIVING SPOUSE/PARTNER (A009 NOT 2)}:

Our records show that (R's FIRST NAME) and [his/her] [husband/wife/partner] owned a home in HH's LAST IW 1ST RESIDENCE CITY, STATE (STATE ABBREVIATION) in [FINANCIAL R's LAST IW [MONTH, ]YEAR/the last two years].

ASK ALL PROXIES:

Please, let me confirm, did R's FIRST NAME still own that home when [he/she] died?



!! EXIT NO 1<sup>st</sup> HOME AT DEATH

T066 (Tag#=T101.5)  
 Did R's FIRST NAME ever own it?

1. YES	5. NO	8. DK	9. RF
--------	-------	-------	-------

GO TO T124 BRANCHPOINT

T102

What happened to that home — did R's FIRST NAME sell it, give it to someone, or what?

1. GAVE TO SOMEONE	2. SOLD	7. OTHER (SPECIFY) T103	8. DK	9. RF
--------------------	---------	----------------------------	-------	-------

GO TO T107      GO TO T124 BRANCHPOINT

T104

To whom did [he/she] give the house, that is, what was their relationship to R's FIRST NAME?

[IWER: CHOOSE ALL THAT APPLY]

1. SPOUSE/PARTNER	2. CHILD/ CHILD-IN-LAW	3. OTHER RELATIVE	4. FRIEND
5. CHARITY	6. GRANDCHILD	7. SOMEONE ELSE	8. DK      9. RF

T105 BRANCHPOINT: IF PROXY DID NOT REPORT THAT R GAVE THE HOUSE TO A CHILD/GRANDCHILD (T104 {NOT 2 and NOT 6}), GO TO T107

T105/T054\_T105

IF CHILD (T104=2):  
(Which child is that?)

IF GRANDCHILD (T104={6 and {NOT 2}}):  
Which child is the parent of that grandchild?

[IWER: CHOOSE ALL THAT APPLY]

CHILD NAME(S) [DISPLAYED BY BLAISE FROM PREVIOUS RESPONSES]
3. THROUGH 52. CHILD NAME(S) [ROWS PROVIDED BY BLAISE AS NECESSARY]
92. DECEASED CHILD
93. ALL CHILDREN
97. OTHER (SPECIFY) [T106]
98. DK
99. RF

NOTE: NAMES OF ALL LIVING AND DEAD CHILDREN ARE DISPLAYED. NAMES OF SPOUSE/PARTNERS OF CHILDREN ARE NOT DISPLAYED.

T107

IF R SOLD THE HOME (T102=2)  
What was the selling price?

OTHERWISE:  
What was the value of that house? I mean, what would it have brought if it had been sold?

[IWER: DO NOT PROBE DK/RF]

\_\_\_\_\_

AMOUNT

DK

RF

**GO TO T124  
BRANCHPOINT**

T108-T110 Unfolding Sequence

Question text: Did it amount to a total of less than \$\_\_\_\_ , more than \$\_\_\_\_ , or what?

PROCEDURES: 1Up1Down, 2Down

BREAKPOINTS: \$15,000, **\$50,000**, **\$200,000**

RANDOM ENTRY POINTS: \$50,000, \$200,000

ENTRY POINT ASSIGNMENT 1 or {NOT 1} AT X502

ORDER OF ENTRY POINT ASSIGNMENTS AND PROCEDURES CORRESPOND

T111 BRANCHPOINT: GO TO T124 BRANCHPOINT

**!! EXIT 1<sup>st</sup> HOME DISPOSAL AFTER DEATH**

T111

What happened to that home after *R's FIRST NAME's* death:

IF PROXY IS THE SURVIVING SPOUSE/PARTNER (A009=2):

Do you own it now, was it sold, was it inherited by someone else, has it not yet been disposed of, or what?

IF {THIS IS NOT A POST-EXIT AND PROXY IS NOT *R's* SPOUSE/PARTNER AND *R's* SPOUSE/PARTNER IS STILL LIVING} (A023=1):

Does [his/her] [husband/wife/partner] own it now, was it sold, was it inherited by someone else, has it not yet been disposed of, or what?

OTHERWISE:

Was it sold, was it inherited by someone else, has it not yet been disposed of, or what?

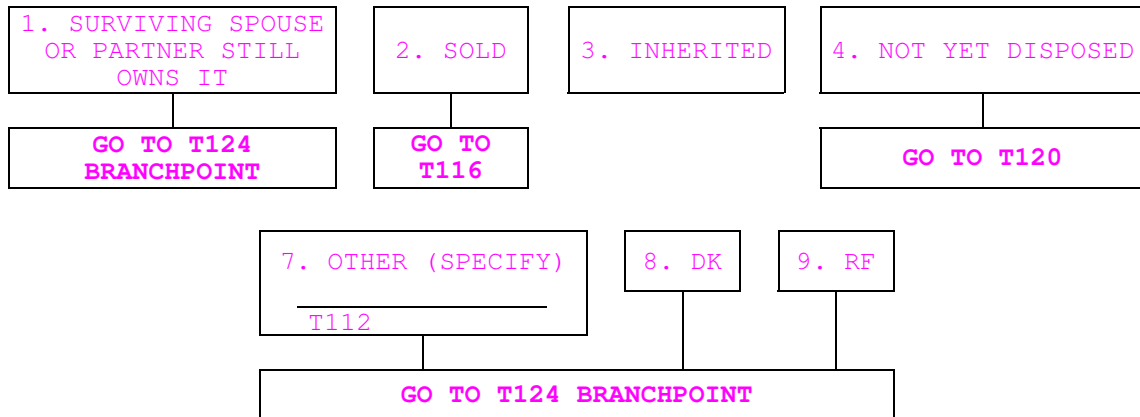

**!! EXIT 1<sup>st</sup> HOME INHERITED**

T113

Who inherited the house, (that is, what was their relationship to *R's FIRST NAME*)?

[IWER: CHOOSE ALL THAT APPLY]

- |                   |                           |                   |           |
|-------------------|---------------------------|-------------------|-----------|
| 1. SPOUSE/PARTNER | 2. CHILD/<br>CHILD-IN-LAW | 3. OTHER RELATIVE | 4. FRIEND |
| 5. CHARITY        | 6. GRANDCHILD             | 7. SOMEONE ELSE   | 8. DK     |
|                   |                           |                   | 9. RF     |

T114 BRANCHPOINT: IF PROXY DID NOT REPORT THAT CHILD/GRANDCHILD INHERITED THE HOUSE (T113 {NOT 2 and NOT 6}), GO TO T116

T114/T055\_T114

IF CHILD (T113=2):  
(Which child is that?)

IF GRANDCHILD (T113={6 and {NOT 2}}):  
Which child is the parent of that grandchild?

[IWER: CHOOSE ALL THAT APPLY]

CHILD NAME(S) [DISPLAYED BY BLAISE FROM PREVIOUS RESPONSES]
3. THROUGH 52. CHILD NAME(S)
[ROWS PROVIDED BY BLAISE AS NECESSARY]
92. DECEASED CHILD
93. ALL CHILDREN
97. OTHER (SPECIFY) [T115]
98. DK
99. RF

NOTE: NAMES OF ALL LIVING AND DEAD CHILDREN ARE DISPLAYED. NAMES OF SPOUSE/PARTNERS OF CHILDREN ARE NOT DISPLAYED.



!! EXIT 1<sup>st</sup> HOME SOLD

T116

IF R SOLD THE HOME (T111=2)  
What was the selling price?

OTHERWISE:

What was the value of that house? I mean, what would it have brought if it had been sold?

[IWER: DO NOT PROBE DK/RF]

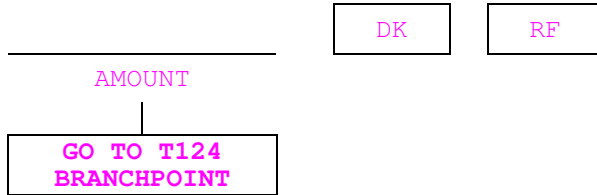

T117-T119 Unfolding Sequence

Question text: Did it amount to a total of less than \$\_\_\_\_ , more than \$\_\_\_\_ , or what?

PROCEDURES: 1Up1Down, 2Down

BREAKPOINTS: \$15,000, \$50,000, \$200,000

RANDOM ENTRY POINTS: \$50,000, \$200,000

ENTRY POINT ASSIGNMENT 1 or {NOT 1} AT X503

ORDER OF ENTRY POINT ASSIGNMENTS AND PROCEDURES CORRESPOND

T120 BRANCHPOINT: GO TO T124 BRANCHPOINT

!! EXIT HOME NOT DISPOSED

T120

Is that home now vacant, or is someone living there?

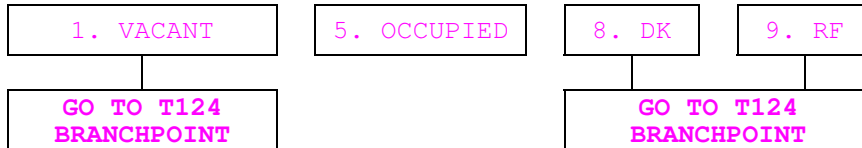

T121

Who lives in the house, (that is, what was their relationship to R's FIRST NAME)?

[IWER: CHOOSE ALL THAT APPLY]

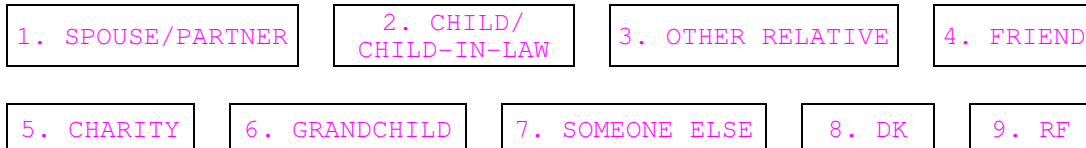

T122 BRANCHPOINT: IF PROXY DID NOT REPORT THAT CHILD/GRANDCHILD LIVES IN HOUSE (T121 {NOT 2 and NOT 6}), GO TO T124 BRANCHPOINT

T122/T056\_T122

IF CHILD (T121=2):  
(Which child is that?)

IF GRANDCHILD (T121={6 and {NOT 2}}):  
Which child is the parent of that grandchild?

[IWER: CHOOSE ALL THAT APPLY]

CHILD NAME(S) [DISPLAYED BY BLAISE FROM PREVIOUS RESPONSES]
3. THROUGH 52. CHILD NAME(S)
[ROWS PROVIDED BY BLAISE AS NECESSARY]
92. DECEASED CHILD
93. ALL CHILDREN
97. OTHER (SPECIFY) [T123]
98. DK
99. RF

NOTE: NAMES OF ALL LIVING AND DEAD CHILDREN ARE DISPLAYED. NAMES OF SPOUSE/PARTNERS OF CHILDREN ARE NOT DISPLAYED.

!! EXIT HOME DISPOSAL - SECOND RESIDENCE

T124 BRANCHPOINT: IF THIS IS A POST-EXIT INTERVIEW (Z145={2 or 3 or 4}),  
GO TO T155 BRANCHPOINT

IF R DID NOT HAVE A SECOND RESIDENCE AT HH's LAST IW  
(X032 NOT 1), GO TO T148

T124

IF {R's LAST IW SPOUSE/PARTNER WAS NOT LIVING WHEN S/HE DIED (A023 NOT 1) and PROXY IS NOT A SURVIVING SPOUSE/PARTNER (A009 NOT 2)} or R {WAS REMARRIED WHEN S/HE DIED (A026=1) and WAS NOT COUPLED AT HH's LAST IW (Preload\_X065 {NOT 1 and NOT 3}):

Our records show that R's FIRST NAME owned a home in HH's LAST IW 2ND RESIDENCE CITY, STATE (STATE ABBREVIATION) [since [FINANCIAL R's LAST IW [MONTH, ]YEAR/in the last two years before [his/her] death].

IF R WAS MARRIED/PARTNERED AT HH's LAST IW (Preload\_X065={1 or 3}) and PROXY IS R's SURVIVING SPOUSE/PARTNER (A009=2):

IF PROXY IS THE SURVIVING SPOUSE/PARTNER (A009=2):

Our records show that you and R's FIRST NAME owned a home in HH's LAST IW 2ND RESIDENCE CITY (X029), STATE (STATE ABBREVIATION) (X030) [since [FINANCIAL R's LAST IW [MONTH, ]YEAR/in the last two years before [his/her] death].

OTHERWISE, IF R's LAST IW SPOUSE/PARTNER WAS LIVING WHEN S/HE DIED (A023=1) and PROXY IS NOT A SURVIVING SPOUSE/PARTNER (A009 NOT 2):

Our records show that R's FIRST NAME and [his/her] [husband/wife/partner] owned a home in HH's LAST IW 2ND RESIDENCE CITY, STATE (STATE ABBREVIATION) [since [FINANCIAL R's LAST IW [MONTH, ]YEAR/in the last two years before [his/her] death].

ASK ALL PROXIES:

Remind me, did [he/she] still own that home when [he/she] died?



!! EXIT 2<sup>ND</sup> HOME DISPOSED BEFORE DEATH

T125

Did R's FIRST NAME ever own it?

1. YES	5. NO	8. DK	9. RF
GO TO T148			

T240 (Tag#=T126)

What happened to that home — did R's FIRST NAME sell it, give it to someone, or what?

1. GAVE TO SOMEONE	2. SOLD	7. OTHER (SPECIFY) _____ T241 (Tag#=T127)	8. DK	9. RF
	GO TO T131	GO TO T148		

!! EXIT 2<sup>ND</sup> HOME INHERITED BEFORE DEATH

T128

To whom did [he/she] give the house, (that is, what was their relationship to R's FIRST NAME)?

[IWER: CHOOSE ALL THAT APPLY]

1. SPOUSE/PARTNER	2. CHILD/ CHILD-IN-LAW	3. OTHER RELATIVE	4. FRIEND
5. CHARITY	6. GRANDCHILD	7. SOMEONE ELSE	8. DK
9. RF			

T129 BRANCHPOINT: IF PROXY DID NOT REPORT THAT CHILD/GRANDCHILD LIVES IN HOUSE (T128 {NOT 2 and NOT 6}), GO TO T131

T129/T057\_T129

IF CHILD (T128=2):  
(Which child is that?)

IF GRANDCHILD (T128={6 and {NOT 2}}):  
Which child is the parent of that grandchild?

[IWER: CHOOSE ALL THAT APPLY]

CHILD NAME(S) [DISPLAYED BY BLAISE FROM PREVIOUS RESPONSES]
3. THROUGH 52. CHILD NAME(S)
[ROWS PROVIDED BY BLAISE AS NECESSARY]
92. DECEASED CHILD
93. ALL CHILDREN
97. OTHER (SPECIFY) [T130]
98. DK
99. RF

NOTE: NAMES OF ALL LIVING AND DEAD CHILDREN ARE DISPLAYED. NAMES OF SPOUSE/PARTNERS OF CHILDREN ARE NOT DISPLAYED.

**!! EXIT 2<sup>ND</sup> HOME SOLD BEFORE DEATH**

T131

IF R SOLD THE HOME (T240=2):  
What was the selling price?

OTHERWISE:  
What was the value of that house? I mean, what would it have brought if it had been sold?

[IWER: DO NOT PROBE DK/RF]

\_\_\_\_\_

AMOUNT

DK	RF
----	----

|

GO TO T148
------------

T132-T134 Unfolding Sequence

Question text: Did it amount to a total of less than \$\_\_\_\_ , more than \$\_\_\_\_ , or what?

PROCEDURES: 1Up1Down, 2Down  
BREAKPOINTS: \$15,000, **\$50,000**, \$200,000  
RANDOM ENTRY POINTS: \$50,000, \$200,000  
ENTRY POINT ASSIGNMENT 1 or {NOT 1} AT X504  
ORDER OF ENTRY POINT ASSIGNMENTS AND PROCEDURES CORRESPOND

T135 BRANCHPOINT: GO TO T148

**!! EXIT 2<sup>ND</sup> HOME DISPOSAL AFTER DEATH**

T135

What happened to that home after R's FIRST NAME's death:

IF PROXY IS THE SURVIVING SPOUSE/PARTNER (A009=2):

Do you own it now, was it sold, was it inherited by someone else, has it not yet been disposed of, or what?

IF {PROXY IS NOT R's SPOUSE/PARTNER AND R's SPOUSE/PARTNER WAS STILL LIVING WHEN S/HE DIED} (A023=1):

Does [his/her] [husband/wife/partner] own it now, was it sold, was it inherited by someone else, has it not yet been disposed of, or what?

OTHERWISE:

Was it sold, was it inherited by someone else, has it not yet been disposed of, or what?

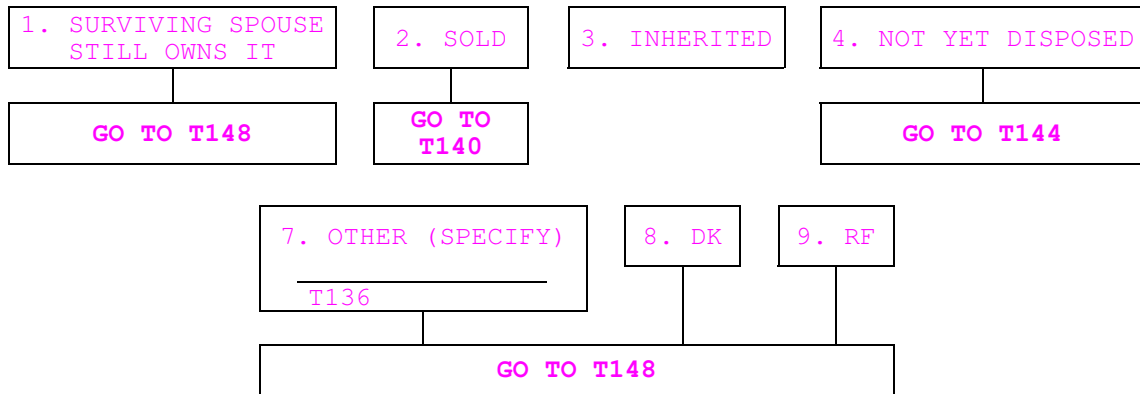

**!! EXIT 2<sup>ND</sup> HOME INHERITED**

T137

Who inherited the house, (that is, what was their relationship to R's FIRST NAME)?

[IWER: CHOOSE ALL THAT APPLY]

- |                   |                           |                   |           |
|-------------------|---------------------------|-------------------|-----------|
| 1. SPOUSE/PARTNER | 2. CHILD/<br>CHILD-IN-LAW | 3. OTHER RELATIVE | 4. FRIEND |
| 5. CHARITY        | 6. GRANDCHILD             | 7. SOMEONE ELSE   | 8. DK     |
|                   |                           |                   | 9. RF     |

T138 BRANCHPOINT: IF PROXY DID NOT REPORT THAT CHILD/GRANDCHILD INHERITED HOUSE (T137 {NOT 2 and NOT 6}), GO TO T140

T138/T058\_T137

IF CHILD (T137=2):

(Which child is that?)

IF GRANDCHILD (T137={6 and {NOT 2}}):

Which child is the parent of that grandchild?

[IWER: CHOOSE ALL THAT APPLY]

CHILD NAME(S) [DISPLAYED BY BLAISE FROM PREVIOUS RESPONSES]
3. THROUGH 52. CHILD NAME(S) [ROWS PROVIDED BY BLAISE AS NECESSARY]
92. DECEASED CHILD
93. ALL CHILDREN
97. OTHER (SPECIFY) [T139]
98. DK
99. RF

NOTE: NAMES OF ALL LIVING AND DEAD CHILDREN ARE DISPLAYED. NAMES OF SPOUSE/PARTNERS OF CHILDREN ARE NOT DISPLAYED.

!! EXIT 2<sup>ND</sup> HOME SOLD

T140

IF R SOLD THE HOME (T135=2):  
What was the selling price?

OTHERWISE:  
What was the value of that house? I mean, what would it have brought if it had been sold?

[IWER: DO NOT PROBE DK/RF]

\_\_\_\_\_

AMOUNT

T141-T143 Unfolding Sequence

Question text: Did it amount to a total of less than \$\_\_\_\_ , more than \$\_\_\_\_ , or what?

PROCEDURE: 1Up1Down  
BREAKPOINTS: \$15,000, \$50,000, \$200,000  
ENTRY POINT: \$50,000

T144 BRANCHPOINT: GO TO T148

!! EXIT 2<sup>ND</sup> HOME NOT DISPOSED YET

T144

Is that home now vacant, or is someone living there?

1. VACANT	5. OCCUPIED	8. DK	9. RF
<input type="button" value="GO TO T148"/>		<input type="button" value="GO TO T148"/>	

T145

Who lives in the house, (that is, what was their relationship to R's FIRST NAME)?

[IWER: CHOOSE ALL THAT APPLY]

1. SPOUSE/PARTNER	2. CHILD/ CHILD-IN-LAW	3. OTHER RELATIVE	4. FRIEND
5. CHARITY	6. GRANDCHILD	7. SOMEONE ELSE	8. DK
			9. RF

T146 BRANCHPOINT: IF PROXY DID NOT REPORT THAT CHILD/GRANDCHILD LIVES IN HOUSE (T145 {NOT 2 and NOT 6}), GO TO T148

T146/T059\_T146

IF CHILD (T145=2):  
(Which child is that?)

IF GRANDCHILD (T145={6 and {NOT 2}}):  
Which child is the parent of that grandchild?

[IWER: CHOOSE ALL THAT APPLY]

CHILD NAME(S) [DISPLAYED BY BLAISE FROM PREVIOUS RESPONSES]
3. THROUGH 52. CHILD NAME(S) [ROWS PROVIDED BY BLAISE AS NECESSARY]
92. DECEASED CHILD
93. ALL CHILDREN
97. OTHER (SPECIFY) [T147]
98. DK
99. RF

NOTE: NAMES OF ALL LIVING AND DEAD CHILDREN ARE DISPLAYED. NAMES OF SPOUSE/PARTNERS OF CHILDREN ARE NOT DISPLAYED.

**!! EXIT DEATH EXPENSES**

T148

I asked you earlier about expenses incurred for the health care that R's FIRST NAME received. Now I want to know about expenses associated with [his/her] death, for funeral expenses, legal fees, and so on.

What were the total expenses associated with the death for things of that type?

[IWER: DO NOT PROBE DK/RF]

[IWER: ENTER 99996 IF NOT SETTLED YET]

99996 NOT SETTLED YET	0	DK	RF
-----------------------	---	----	----



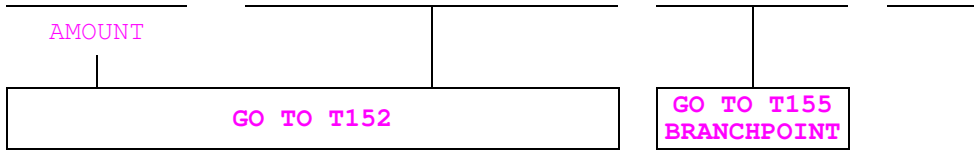

T149-T151 Unfolding Sequence

Question text: Did it amount to less than \$\_\_\_\_ , more than \$\_\_\_\_ , or what?

PROCEDURES: 2Up1Down, 1Up2Down

BREAKPOINTS: \$1,000, \$5,000, \$25,000, \$100,000

RANDOM ENTRY POINTS: \$5,000, \$25,000

ENTRY POINT ASSIGNMENT 1 or {NOT 1} AT X505

ORDER OF ENTRY POINT ASSIGNMENTS AND PROCEDURES CORRESPOND

T152

Excluding life insurance, were any of these costs covered by insurance?

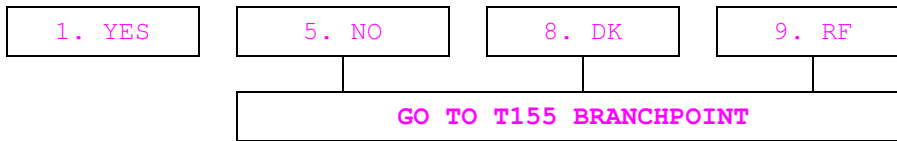

T153

How much did insurance pay?



!! EXIT INHERITANCE

T155 BRANCHPOINT: IF THIS IS A POST-EXIT IW *and* WE DON'T NEED TO ASK ABOUT THE WILL/TRUST (Z146 {NOT 2 *and* NOT 3}), GO TO T173

T155

Sometimes people make provisions to leave things to specific family members if something happens to them, others do not. Because we are trying to get a complete picture of family situations, I have a few questions about inheritance.

Before [his/her] death, had *R's FIRST NAME* put any of [his/her] assets into a trust?

- |        |       |       |       |
|--------|-------|-------|-------|
| 1. YES | 5. NO | 8. DK | 9. RF |
|--------|-------|-------|-------|

T156

IF R PUT ASSETS INTO TRUST (T155=1):  
In addition to the trust, did *R's FIRST NAME* have a will that was written and witnessed?

OTHERWISE:

Did *R's FIR0053T NAME* have a will that was written and witnessed?

- |                        |       |       |       |
|------------------------|-------|-------|-------|
| 1. YES                 | 5. NO | 8. DK | 9. RF |
| GO TO T161 BRANCHPOINT |       |       |       |

T157

Has [his/her] will been probated?

- |  |                                 |  |
|--|---------------------------------|--|
| 1. YES   | 2. [VOL] NO: PROBATE NOT NEEDED | 3. [VOL] NO: NO ASSETS REMAINED TO BE PROBATED |
| GO TO T161 BRANCHPOINT   |                                 |  |
| 4. [VOL] NO: ALL ASSETS WERE HELD IN JOINT TENANCY OR IN A TRUST |                                 | 5. NO  |
| GO TO T161 BRANCHPOINT   |                                 |  |
| 7. [VOL] R DISPUTES RECORD                                       | 8. DK                           | 9. RF  |
| GO TO T161 BRANCHPOINT   |                                 |  |

T158

In what state was it probated?

STATE	OTHER COUNTRY (SPECIFY) T159	98. DK	99. RF
	GO TO T161 BRANCHPOINT	GO TO T161 BRANCHPOINT	

NOTE: THE IWER SELECTS FROM A MENU OF STATE NAMES, INCLUDING WASHINGTON, D.C., AND PUERTO RICO.

T160

In what county was it probated?

COUNTY	98. DK	99. RF
--------	--------	--------

T161 BRANCHPOINT: IF R HAD {A TRUST or A PROBATED WILL} ({T155 or T157}=1), GO TO T163 LOOP BRANCHPOINT

**!! EXIT DISTRIBUTION OF ASSETS**

T161

The next questions are about R's FIRST NAME's assets and possessions, excluding any life insurance.

Have they been divided up among the heirs, have they not yet been distributed, was there nothing of much value to distribute, or what?

1. DIVIDED AMONG THE HEIRS, OR RETAINED BY THOSE WITH JOINT TENANCY	2. NOT YET DISTRIBUTED		
3. NOTHING MUCH OF VALUE	7. OTHER (SPECIFY) T162	8. DK	9. RF

T163 LOOP BRANCHPOINT: IF {R HAD NEITHER A TRUST NOR A PROBATED WILL ({T155 and T157} NOT 1)} and {{ASSETS/POSSESSIONS WERE NOT DIVIDED AMONG HEIRS and THE RESPONSE WAS NOT OTHER (SPECIFY)} (T161 {NOT 1 and NOT 7})}, GO TO T177 BRANCHPOINT

IF R WAS NOT PART OF A COUPLE (X065 {NOT 1 and NOT 3}), GO TO T164 BRANCHPOINT

**T163 THROUGH T908-8 ARE ASKED FOR POTENTIAL BENEFICIARIES OF R'S ESTATE.**

T163

IF R HAD {A TRUST and/or A WILL} ({T155 and T156}=1 or T155=1 or T156=1):  
Did [he/she] make provisions in [either the trust or the will/the trust/the will] for [you/[his/her] [husband/wife/partner]]?

OTHERWISE:

Were any of [his/her] possessions or assets left to [you/[his/her] [husband/wife/partner]]?

1. YES	5. NO	8. DK	9. RF
GO TO T164 BRANCHPOINT			

\*\*\*BEGINNING OF **BLOCK\_1: AMOUNT TO SPOUSE/PARTNER**  
(T902\_1 - T908\_1)

T902\_1

Excluding any life insurance, how much did [you/[his/her] [husband/wife/partner]] receive from [his/her] estate?

[IWER: ACCEPT EITHER A DOLLAR AMOUNT OR A PERCENTAGE]

[IWER: DO NOT PROBE DK/RF]

_____	OR	_____	DK	RF
T902_1 AMOUNT		T903_1 PERCENT		
GO TO T164 BRANCHPOINT				

T904\_1

Was it more than half of [his/her] estate?

1. YES	5. NO	8. DK	9. RF
	GO TO T907_1	GO TO T164 BRANCHPOINT	

T905\_1

Was it more than 75 percent of [his/her] estate?

1. YES	5. NO	8. DK	9. RF
GO TO T164 BRANCHPOINT			

T906\_1

Was it more than 90 percent of [his/her] [his/her] estate?

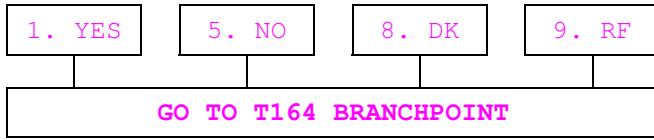

T907\_1

Was it more than 25 percent of [his/her] estate?

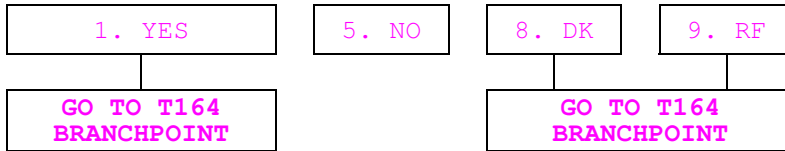

T908\_1

Was it more than 10 percent of [his/her] estate?

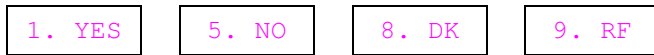

\*\*\*END OF **BLOCK\_1**: AMOUNT TO SPOUSE/PARTNER (T902\_1 - T908\_1)

T164 BRANCHPOINT: IF R DOES NOT HAVE ANY CHILDREN (A101=0) and {{THIS IS A NEW EXIT IW (A007=5 and {Z145 {NOT 2 and NOT 3 and NOT 4}}) and {PROXY DID NOT REPORT THAT R HAD GRANDCHILDREN (E046 NOT {>0 - <81}}) or {THIS IS A POST-EXIT IW (Z145={2 or 3 or 4}) and R WAS NOT REPORTED IN A PREVIOUS WAVE TO HAVE GRANDCHILDREN (Z114 NOT {>0 - <81}})}, GO TO T168

T164

IF R HAD {A TRUST and/or A WILL} ({T155 and T156}=1 or T155=1 or T156=1):  
(Again,) excluding any life insurance, did [he/she] make provisions in [either the trust or the will/the trust/the will] for any of [his/her] [children or grandchildren (or great-grandchildren)/ children/grandchildren (or great-grandchildren)]?

OTHERWISE:

(Again,) excluding any life insurance, were any of [his/her] possessions or assets left to any of [his/her] [children or grandchildren (or great-grandchildren)/ children/grandchildren (or great-grandchildren)]?

[IWER: PLEASE RECORD ANY INFORMATION ABOUT ULTIMATE BENEFICIARIES IN F2 COMMENTS]

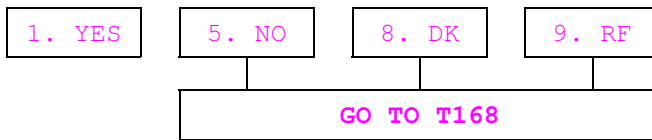

T165 BRANCHPOINT: IF R DOES NOT HAVE ANY CHILDREN (A101=0), GO TO T166 BRANCHPOINT

IF R HAS ONLY ONE CHILD (A101=1), GO TO T902\_2

T165

Did R's FIRST NAME provide equally for all of [his/her] children and their families?

[IWER: WE ARE INTERESTED IN THE TOTAL AMOUNT GIVEN TO EACH OF R'S CHILDREN AND THEIR SPOUSES AND CHILDREN.]

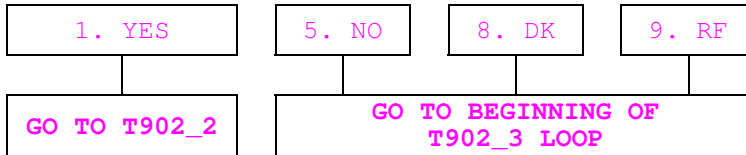

T166 BRANCHPOINT: IF R HAS/HAD ONLY ONE GRANDCHILD (E046=1 or Z114=1), ASSIGN 1 TO T166 AND GO TO T902\_2

T166

Did [he/she] leave the same amount to each of [his/her] grandchildren?



\*\*\*BEGINNING OF **BLOCK\_2: SAME AMOUNT TO ALL CHILDREN**  
(T902\_2 - T908\_2)

T902\_2

IF R LEFT EQUAL AMOUNTS TO EACH (CHILD AND FAMILY) (T165=1):  
Altogether, how much did [he/she] leave for [his/her] children and their families?

IF R HAS ONLY 1 CHILD (A101=1):  
Altogether, how much did [he/she] leave for [his/her] child and (his/her) family?

IF {PROXY WAS ASKED WHETHER R LEFT EQUAL AMOUNTS TO GRANDCHILDREN or VALUE WAS ASSIGNED} (T166 NOT EMPTY):  
Altogether, how much did [he/she] leave for [his/her] (grandchild/grandchildren)?

[IWER: ACCEPT EITHER A DOLLAR AMOUNT OR A PERCENTAGE]

[IWER: DO NOT PROBE DK/RF]

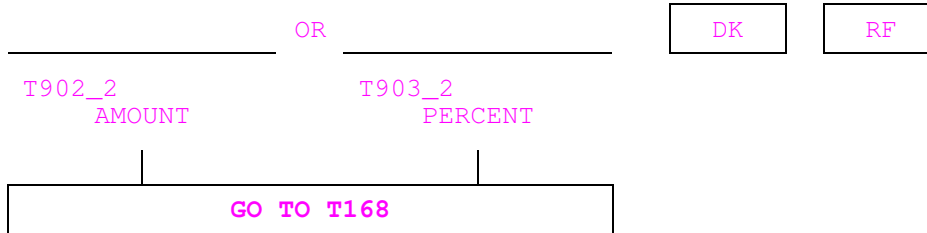

T904\_2

Was it more than half of [his/her] estate?

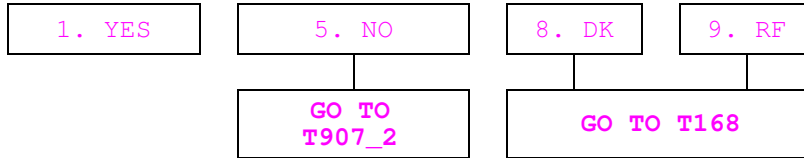

T905\_2

Was it more than 75 percent of [his/her] estate?

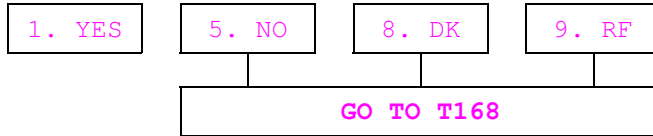

T906\_2

Was it more than 90 percent of [his/her] estate?

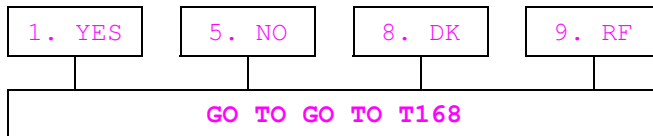

T907\_2

Was it more than 25 percent of [his/her] estate?

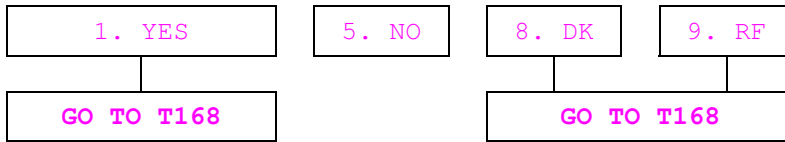

T908\_2

Was it more than 10 percent of [his/her] estate?

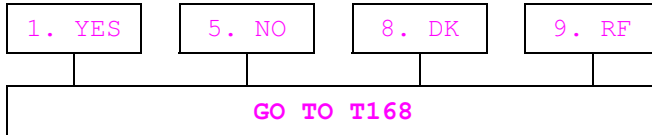

\*\*\*END OF **BLOCK\_2**: SAME AMOUNT TO ALL CHILDREN (T902\_2 - T908\_2)

T902\_3 LOOP BRANCHPOINT: GO TO T168

\*\*\*BEGINNING OF T902\_3 LOOP: ESTATE DISPERSAL TO EACH CHILD

T902\_2 - T908\_2 ARE ASKED FOR EACH CHILD

\*\*\*BEGINNING OF **BLOCK\_3**: AMOUNT TO EACH CHILD

(T902\_3 - T908\_3)

NOTE: THIS BLOCK IS REPEATED FOR EACH CHILD LISTED FOR A HOUSEHOLD.

T902\_3

(Excluding any life insurance,) how much did [he/she] leave for CHILDn's NAME and (his/her) family?

[IWER: ACCEPT EITHER A DOLLAR AMOUNT OR A PERCENTAGE]

[IWER: DO NOT PROBE DK/RF]

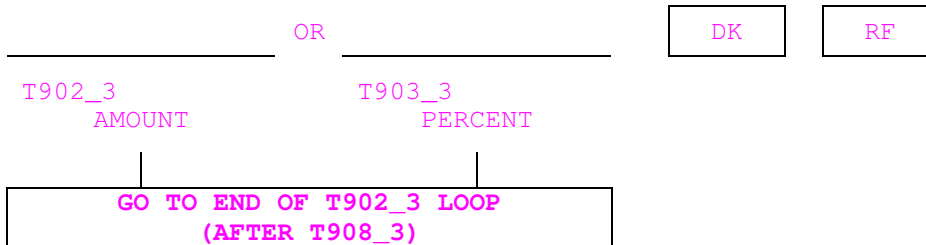



T904\_3

Was it more than half of [his/her] estate?

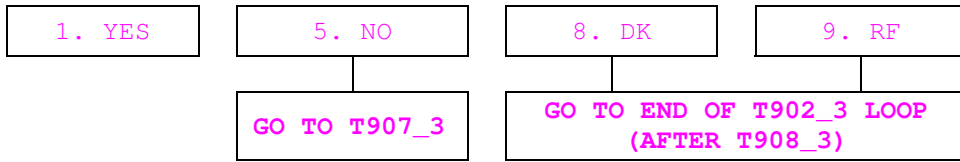

T905\_3

Was it more than 75 percent of [his/her] estate?

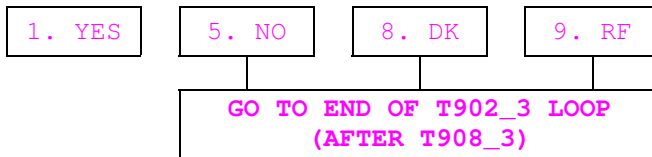

T906\_3

Was it more than 90 percent of [his/her] estate?

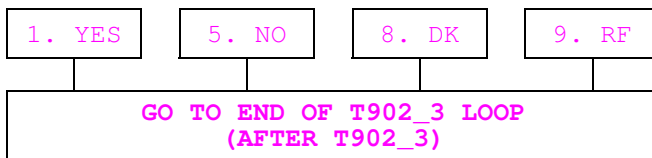

T907\_3

Was it more than 25 percent of [his/her] estate?

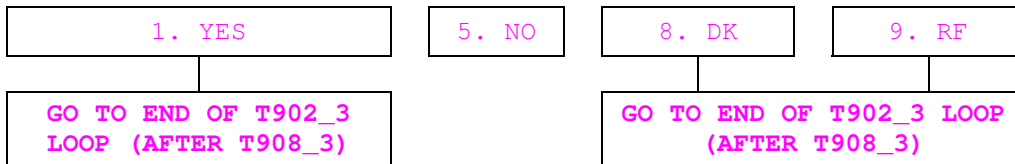

T908\_3

Was it more than 10 percent of [his/her] estate?



\*\*\*END OF **BLOCK\_3**: AMOUNT TO EACH CHILD (T902\_3 - T908\_3)

**\*\*\*END OF T902\_3 LOOP: ESTATE DISPERSAL TO EACH CHILD**

IF THERE ARE NO MORE CHILDREN, CONTINUE ON TO T168. OTHERWISE, GO BACK TO BEGINNING OF T902\_3 LOOP

T168

IF R HAD {A TRUST and/or A WILL} ({T155 and T156}=1 or T155=1 or T156=1):  
(Excluding any life insurance,) did [he/she] make provisions in [either the trust or the will/the trust/the will] for charities?

OTHERWISE:

(Excluding any life insurance,) were any of [his/her] possessions or assets left to charities?

1. YES	5. NO	8. DK	9. RF
GO TO T169			

\*\*\*BEGINNING OF **BLOCK\_4: AMOUNT TO CHARITIES**  
(T902\_4 - T908\_4)

T902\_4

How much did charities receive from [his/her] estate?

[IWER: ACCEPT EITHER A DOLLAR AMOUNT OR A PERCENTAGE]

[IWER: DO NOT PROBE DK/RF]

_____	OR	_____	DK	RF
T902_4 AMOUNT		T903_4 PERCENT		
GO TO T169				

T904\_4

Was it more than half of [his/her] estate?

1. YES	5. NO	8. DK	9. RF
GO TO T907_4		GO TO T169	

T905\_4

Was it more than 75 percent of [his/her] estate?

1. YES	5. NO	8. DK	9. RF
GO TO T169			

T906\_4

Was it more than 90 percent of [his/her] estate?

1. YES	5. NO	8. DK	9. RF
GO TO T169			

T907\_4

Was it more than 25 percent of [his/her] estate?

1. YES	5. NO	8. DK	9. RF
GO TO T169		GO TO T169	

T908\_4

Was it more than 10 percent of [his/her] estate?

1. YES	5. NO	8. DK	9. RF
--------	-------	-------	-------

\*\*\*END OF **BLOCK\_4**: AMOUNT TO CHARITIES (T902\_4 - T908\_4)

T169

IF R HAD {A TRUST *and/or* A WILL} ({T155 *and* T156}=1 or T155=1 or T156=1):  
 (Excluding any life insurance,) did [he/she] make provisions in [either the trust or the will/the trust/the will] for any of [his/her] brothers or sisters??

OTHERWISE:

(Excluding any life insurance,) were any of [his/her] possessions or assets left to any of [his/her] brothers or sisters??

1. YES	5. NO	8. DK	9. RF
GO TO T170			



1. YES	5. NO	8. DK	9. RF
--------	-------	-------	-------

\*\*\*END OF **BLOCK\_5: AMOUNT TO SIBLINGS** (T902\_5 - T908\_5)

T170

IF R HAD {A TRUST and/or A WILL} ({T155 and T156}=1 or T155=1 or T156=1):  
(Excluding any life insurance,) did [he/she] make provisions in [either the trust or the will/the trust/the will] for any other of [his/her] relatives?

OTHERWISE:

Excluding any life insurance,) were any of [his/her] possessions or assets left to any other of [his/her] relatives?

1. YES	5. NO	8. DK	9. RF
GO TO T171			

\*\*\*BEGINNING OF **BLOCK\_6: AMOUNT TO OTHER RELATIVES**  
(T902\_6 - T908\_6)

T902\_6

Altogether, how much did these other relatives receive from [his/her] estate?

[IWER: ACCEPT EITHER A DOLLAR AMOUNT OR A PERCENTAGE]

[IWER: DO NOT PROBE DK/RF]

_____	OR	_____	DK	RF
T902_6 AMOUNT		T903_6 PERCENT		
GO TO T171				

T904\_6

Was it more than half of [his/her] estate?

1. YES	5. NO	8. DK	9. RF
	GO TO T907_6	GO TO T171	

T905\_6

Was it more than 75 percent of [his/her] estate?

1. YES	5. NO	8. DK	9. RF

GO TO T171

T906\_6

Was it more than 90 percent of [his/her] estate?

1. YES	5. NO	8. DK	9. RF
GO TO T171			

T907\_6

Was it more than 25 percent of [his/her] estate?

1. YES	5. NO	8. DK	9. RF
GO TO T171		GO TO T171	

T908\_6

Was it more than 10 percent of [his/her] estate?

1. YES	5. NO	8. DK	9. RF
--------	-------	-------	-------

\*\*\*END OF **BLOCK\_6**: AMOUNT TO OTHER RELATIVES (T902\_6 - T908\_6)

T171

IF R HAD {A TRUST and/or A WILL} ({T155 and T156}=1 or T155=1 or T156=1):  
(Excluding any life insurance,) did [he/she] make provisions in [either the trust or the will/the trust/the will] for any of [his/her] friends?

OTHERWISE:

Excluding any life insurance,) were any of [his/her] possessions or assets left to any of [his/her] friends?

1. YES	5. NO	8. DK	9. RF
GO TO T172			

\*\*\*BEGINNING OF **BLOCK\_7: AMOUNT TO FRIENDS**  
(T902\_7 - T908\_7)

T902\_7

Altogether, how much did [his/her] friends receive from [his/her] estate?

[IWER: ACCEPT EITHER A DOLLAR AMOUNT OR A PERCENTAGE]

[IWER: DO NOT PROBE DK/RF]

\_\_\_\_\_ OR \_\_\_\_\_  DK  RF

T902\_7 AMOUNT                      T903\_7 PERCENT

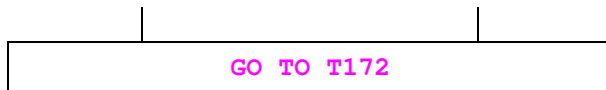

T904\_7

Was it more than half of [his/her] estate?

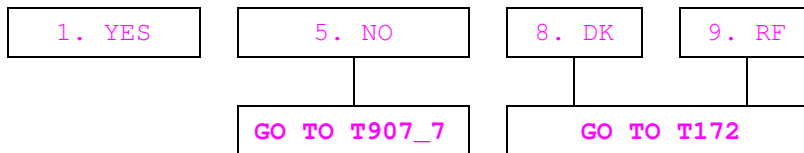

T905\_7

Was it more than 75 percent of [his/her] estate?

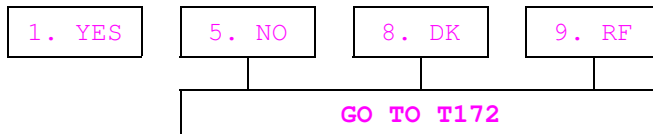

T906\_7

Was it more than 90 percent of [his/her] estate?

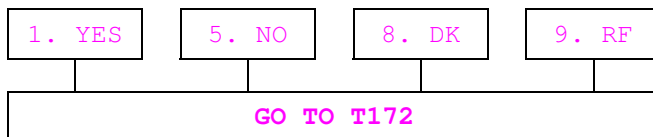

T907\_7

Was it more than 25 percent of [his/her] estate?

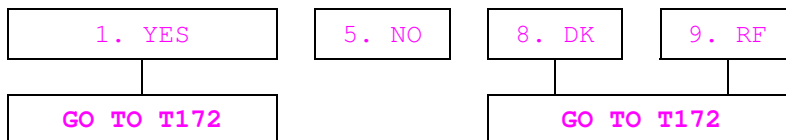

T908\_7

Was it more than 10 percent of [his/her] estate?

1. YES	5. NO	8. DK	9. RF
--------	-------	-------	-------

\*\*\*END OF **BLOCK\_7**: AMOUNT TO FRIENDS (T902\_7 - T908\_7)

T172

IF R HAD {A TRUST *and/or* A WILL} ({T155 *and* T156}=1 or T155=1 or T156=1):  
(Excluding any life insurance,) did [he/she] make provisions in [either the trust or the will/the trust/the will] for anyone else or anything else that we have not yet listed?

OTHERWISE:

Excluding any life insurance,) were any of [his/her] possessions or assets left to anyone else or anything else that we have not yet listed?

1. YES	5. NO	8. DK	9. RF
GO TO T173			

\*\*\*BEGINNING OF **BLOCK\_8**: AMOUNT TO OTHERS  
(T902\_8 - T908\_8)

T902\_8

Altogether, how much did those others receive from [his/her] estate?

[IWER: ACCEPT EITHER A DOLLAR AMOUNT OR A PERCENTAGE]

[IWER: DO NOT PROBE DK/RF]

_____	OR	_____	DK	RF
T902_8 AMOUNT		T903_8 PERCENT		
GO TO T173				

T904\_8

Was it more than half of [his/her] estate?

1. YES	5. NO	8. DK	9. RF
	GO TO T907_8	GO TO T173	

T905\_8

Was it more than 75 percent of [his/her] estate?

1. YES	5. NO	8. DK	9. RF



GO TO T173

T906\_8

Was it more than 90 percent of [his/her] estate?

1. YES	5. NO	8. DK	9. RF
GO TO T173			

T907\_8

Was it more than 25 percent of [his/her] estate?

1. YES	5. NO	8. DK	9. RF
GO TO T173		GO TO T173	

T908\_8

Was it more than 10 percent of [his/her] estate?

1. YES	5. NO	8. DK	9. RF
--------	-------	-------	-------

\*\*\*END OF BLOCK\_8: AMOUNT TO OTHERS (T902\_8 - T908\_8)

\*\*\*END OF T163 ESTATE DISPERSAL LOOP. CONTINUE ON TO T173.

!! EXIT VALUE OF ESTATE

T173

Excluding any life insurance, altogether what was the value of [his/her] total estate?

[IWER: DO NOT PROBE DK/RF]

_____	DK	RF
AMOUNT		
GO TO T242 BRANCHPOINT		

T174-T176 Unfolding Sequence

Question text: Did it amount to a total of less than \$\_\_\_\_ , more than \$\_\_\_\_ , or what?

PROCEDURES: 3Up1Down, 2Up2Down, 1Up3Down  
BREAKPOINTS: \$10,000, **\$25,000**, \$100,000, \$500,000, \$2,000,000  
RANDOM ENTRY POINTS: \$25,000, \$100,000, \$500,000  
ENTRY POINT ASSIGNMENT [1 (\$100,000)] or [2 (\$25,000)] or  
[ {NOT 1 and NOT 2} (\$500,000) ] AT X511

T242 BRANCHPOINT: IF THIS IS A POST-EXIT INTERVIEW (Z145={2 or 3 or 4}) and PROXY DID NOT SAY R STILL OWNED HOME AT TIME OF DEATH (T101 NOT 1), GO TO END OF INTERVIEW

IF THIS IS NOT A POST-EXIT IW (Z145 {NOT 2 and NOT 3 and NOT 4})) and R DID NOT OWN RESIDENCE/MOBILE HOME/FARM IN HH's LAST IW (X079 NOT 1), GO TO T177

T242 (Tag#=T176.5)  
Does that include the value of the home?

1. YES	5. NO	8. DK	9. RF
--------	-------	-------	-------

T177 BRANCHPOINT: IF THIS IS A POST-EXIT INTERVIEW (Z145={2 or 3 or 4}), GO TO END OF INTERVIEW

**!! EXIT ESTATE IN TRUST**

T177

IF R PUT ASSETS INTO TRUST (T155=1):  
Is any part of [his/her] estate still held in any type of a trust?

OTHERWISE:

Was any part of [his/her] estate put into a trust after [he/she] died?

1. YES	5. NO	8. DK	9. RF
GO TO T181 BRANCHPOINT			

T178

Who is currently the trustee of this trust?

[IWER: CHOOSE ALL THAT APPLY]

DEFINITION: A TRUSTEE IS A PERSON WHO ADMINISTERS OR MANAGES THE TRUST.

1. SPOUSE/PARTNER	2. CHILD/ CHILD-IN-LAW	3. OTHER RELATIVE	4. ATTORNEY	
5. BANK OFFICER/TRUST DEPARTMENT AT A BANK	6. GRANDCHILD	7. OTHER (SPECIFY) T179	8. DK	9. RF

T180 BRANCHPOINT: IF PROXY DID NOT REPORT THAT TRUSTEE IS A CHILD/GRANDCHILD (T178 {NOT 2 and NOT 6}), GO TO T181 BRANCHPOINT

T180/T065\_T180

IF CHILD (T178=2):  
(Which child is that?)

IF GRANDCHILD (T178={6 and {NOT 2}}):  
Which child is the parent of that grandchild?

[IWER: CHOOSE ALL THAT APPLY]

CHILD NAME(S) [DISPLAYED BY BLAISE FROM PREVIOUS RESPONSES]
3. THROUGH 52. CHILD NAME(S)
[ROWS PROVIDED BY BLAISE AS NECESSARY]
92. DECEASED CHILD
97. OTHER (SPECIFY) [T238]
98. DK
99. RF

NOTE: NAMES OF ALL LIVING AND DEAD CHILDREN ARE DISPLAYED. NAMES OF SPOUSE/PARTNERS OF CHILDREN ARE NOT DISPLAYED.

**!! EXIT LIFE INSURANCE SETTLEMENT**

T181

IF R HAD {A TRUST or A WILL} (T155=1 or T156=1) or THE WILL HAS BEEN PROBATED (T157=1) or {ASSETS AND POSSESSIONS} WERE DIVIDED AMONG THE HEIRS (T161=1):

In addition to what you have just told me about [his/her] estate did anyone receive a settlement from life insurance?

OTHERWISE:

Did anyone receive a settlement from life insurance?

1. YES	5. NO	8. DK	9. RF
GO TO T190			

T182

Who were the beneficiaries of that life insurance?

[IWER: CHOOSE ALL THAT APPLY]

1. SPOUSE/PARTNER	2. CHILD(REN)	3. GRANDCHILD(REN) OR GREAT-GRANDCHILD(REN)
4. OTHER RELATIVE(S)	7. OTHER (SPECIFY) T183	8. DK
		9. RF

T184 BRANCHPOINT: IF PROXY {DID NOT REPORT THAT BENEFICIARY IS CHILD(REN) and DID NOT REPORT THAT IS GRANDCHILD(REN)} (T182 {NOT 2 and NOT 3}), GO TO T902\_11 BRANCHPOINT

IF R HAS ONLY ONE CHILD (A101=1), GO TO BEGINNING OF T902\_10 LOOP

T184

Did each of [his/her] children and their families receive the same amount from life insurance?

1. YES	5. NO	8. DK	9. RF
GO TO BEGINNING OF T902_10 LOOP			

**\*\*\*BEGINNING OF T902\_9 LOOP: LIFE INSURANCE DISPERSAL**

T902\_9 THROUGH T908\_13 ARE ASKED ABOUT ALL CHILD BENEFICIARIES OF R's LIFE INSURANCE COMBINED.

**\*\*\*BEGINNING OF BLOCK\_9: LIFE INSURANCE: SAME AMOUNT TO ALL CHILDREN (T902\_9 - T908\_9)**

T902\_9

Altogether, how much did [his/her] children receive from [his/her] life insurance?

[IWER: ACCEPT EITHER A DOLLAR AMOUNT OR A PERCENTAGE]

[IWER: DO NOT PROBE DK/RF]

_____	OR	_____	DK	RF
T902_9 AMOUNT		T903_9 PERCENT		
GO TO T902_11 BRANCHPOINT				

T904\_9

Was it more than half of [his/her] life insurance settlement?

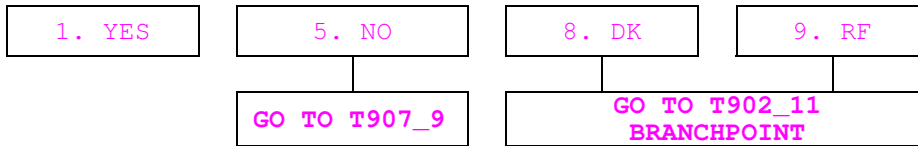

T905\_9  
Was it more than 75 percent of [his/her] life insurance settlement?

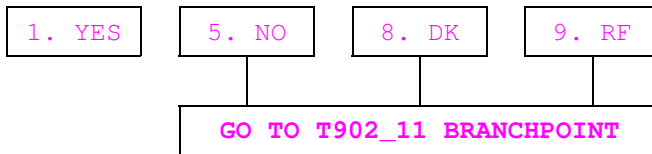

T906\_9  
Was it more than 90 percent of [his/her] life insurance settlement?

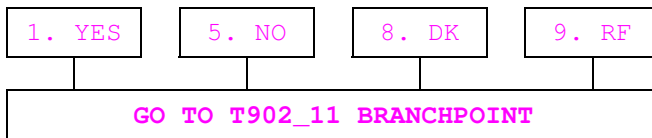

T907\_9  
Was it more than 25 percent of [his/her] life insurance settlement?

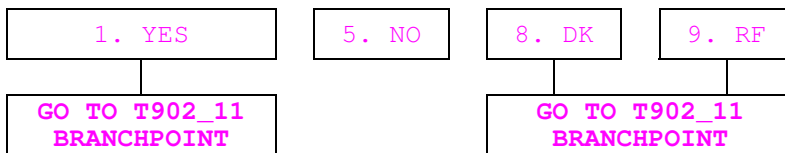

T908\_9  
Was it more than 10 percent of [his/her] life insurance settlement?

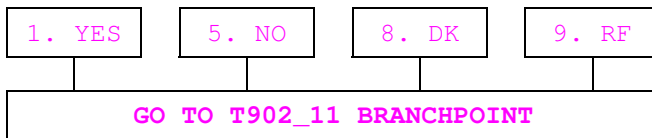

\*\*\*END OF **BLOCK\_9: LIFE INSURANCE:** SAME AMOUNT TO ALL CHILDREN  
(T902\_9 - T908\_9)

\*\*\* BEGINNING OF T902\_10 LOOP: LIFE INSURANCE TO EACH CHILD  
T902\_10 THROUGH T908\_10 ARE ASKED FOR EACH CHILD.

\*\*\*BEGINNING OF BLOCK\_10: LIFE INSURANCE: AMOUNT TO EACH CHILD  
(T902\_10 - T908\_10)

NOTE: THIS BLOCK IS REPEATED FOR EACH CHILD LISTED FOR A HOUSEHOLD.

T902\_10

How much did CHILDn NAME and (his/her) family receive from life insurance?

[IWER: ACCEPT EITHER A DOLLAR AMOUNT OR A PERCENTAGE]

[IWER: DO NOT PROBE DK/RF]

\_\_\_\_\_ OR \_\_\_\_\_

T902\_10                      T903\_10  
AMOUNT                      PERCENT

DK      RF

GO TO END OF T902\_10 LOOP (AFTER T908\_10)

T904\_10

Was it more than half of [his/her] life insurance settlement?

1. YES      5. NO      8. DK      9. RF

GO TO T907\_10      GO TO END OF T902\_10 LOOP (AFTER T908\_10)

T905\_10

Was it more than 75 percent of [his/her] life insurance settlement?

1. YES      5. NO      8. DK      9. RF

GO TO END OF T902\_10 LOOP (AFTER T908\_10)

T906\_10

Was it more than 90 percent of [his/her] life insurance settlement?

1. YES      5. NO      8. DK      9. RF

GO TO END OF T902\_10 LOOP (AFTER T908\_10)

T907\_10

Was it more than 25 percent of [his/her] life insurance settlement?

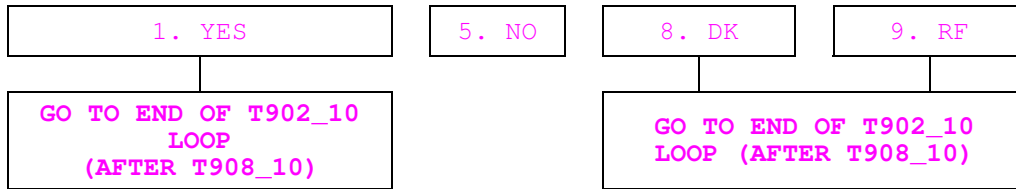

T908\_10

Was it more than 10 percent of [his/her] life insurance settlement?

1. YES	5. NO	8. DK	9. RF
--------	-------	-------	-------

\*\*\*END OF **BLOCK\_10: LIFE INSURANCE: AMOUNT TO EACH CHILD**  
(T902\_10 - T908\_10)

**\*\*\*END OF T902\_10 LOOP: LIFE INSURANCE TO EACH CHILD**  
IF THERE ARE NO MORE CHILDREN, CONTINUE ON TO T902\_11 BRANCHPOINT. OTHERWISE,  
GO BACK TO BEGINNING OF T902\_10 LOOP

T902\_11 BRANCHPOINT: IF LIFE INSURANCE BENEFICIARY WAS R's SPOUSE/PARTNER  
(T182=1), CONTINUE ON TO T902\_11  
OTHERWISE, GO TO T902\_12 BRANCHPOINT



\*\*\*BEGINNING OF **BLOCK\_11: LIFE INSURANCE: AMOUNT TO SPOUSE/PARTNER**  
(T902\_11 - T908\_11)

T902\_11

Altogether, how much did [you/[his/her] [husband/wife/partner]]  
receive from [his/her] life insurance?

[IWER: ACCEPT EITHER A DOLLAR AMOUNT OR A PERCENTAGE]

[IWER: DO NOT PROBE DK/RF]

\_\_\_\_\_ OR \_\_\_\_\_

T902\_11 AMOUNT      T903\_11 PERCENT

DK      RF

GO TO T902\_12 BRANCHPOINT

T904\_11

Was it more than half of [his/her] life insurance settlement?

1. YES      5. NO      8. DK      9. RF

GO TO T907\_11      GO TO T902\_12 BRANCHPOINT

T905\_11

Was it more than 75 percent of [his/her] life insurance settlement?

1. YES      5. NO      8. DK      9. RF

GO TO T902\_12 BRANCHPOINT

T906\_11

Was it more than 90 percent of [his/her] life insurance settlement?

1. YES      5. NO      8. DK      9. RF

GO TO T902\_12 BRANCHPOINT

T907\_11

Was it more than 25 percent of [his/her] life insurance settlement?

1. YES      5. NO      8. DK      9. RF

GO TO T902\_12 BRANCHPOINT      GO TO T902\_12 BRANCHPOINT

T908\_11

Was it more than 10 percent of [his/her] life insurance settlement?

1. YES	5. NO	8. DK	9. RF
--------	-------	-------	-------

\*\*\*END OF **BLOCK\_11: LIFE INSURANCE: AMOUNT TO SPOUSE/PARTNER**  
(T902\_11 - T908\_11)

T902\_12 BRANCHPOINT: IF R'S LIFE INSURANCE BENEFICIARY WAS OTHER RELATIVE(S)  
(T182=4)}, CONTINUE ON TO T902\_12  
  
OTHERWISE, GO TO T902\_13 BRANCHPOINT

\*\*\*BEGINNING OF **BLOCK\_12: LIFE INSURANCE: AMOUNT TO OTHER RELATIVES**  
(T902\_12 - T908\_12)

T902\_12

Altogether, how much did [his/her] other relatives receive from  
[his/her] life insurance?

[IWER: ACCEPT EITHER A DOLLAR AMOUNT OR A PERCENTAGE]

[IWER: DO NOT PROBE DK/RF]

\_\_\_\_\_ OR \_\_\_\_\_

T902\_12                      T903\_12

AMOUNT                      PERCENT



GO TO T902\_13 BRANCHPOINT

T904\_12

Was it more than half of [his/her] life insurance settlement?

1. YES	5. NO	8. DK	9. RF
--------	-------	-------	-------

GO TO T907\_12

GO TO T902\_13  
BRANCHPOINT

T905\_12

Was it more than 75 percent of [his/her] life insurance settlement?

1. YES	5. NO	8. DK	9. RF
--------	-------	-------	-------

GO TO T902\_13 BRANCHPOINT

T906\_12

Was it more than 90 percent of [his/her] life insurance settlement?

1. YES	5. NO	8. DK	9. RF
--------	-------	-------	-------

GO TO T902\_13

T907\_12

Was it more than 25 percent of [his/her] life insurance settlement?

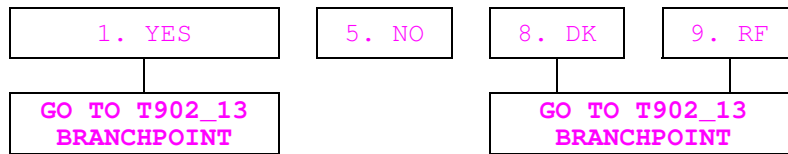

T908\_12

Was it more than 10 percent of [his/her] life insurance settlement?



\*\*\*END OF **BLOCK\_12: LIFE INSURANCE: AMOUNT TO OTHER RELATIVES**  
(T902\_12 - T908\_12)

T902\_13 BRANCHPOINT: IF RESPONSE TO LIFE INSURANCE BENEFICIARY WAS OTHER (SPECIFY) (T182=7)}, CONTINUE ON TO T902\_13  
OTHERWISE, GO TO T186 BRANCHPOINT

\*\*\*BEGINNING OF **BLOCK\_13: LIFE INSURANCE: AMOUNT TO NON-RELATIVES**  
(T902\_13 - T908\_13)

T902\_13

Altogether, how much did other non-relatives receive from [his/her] life insurance?

[IWER: ACCEPT EITHER A DOLLAR AMOUNT OR A PERCENTAGE]

[IWER: DO NOT PROBE DK/RF]

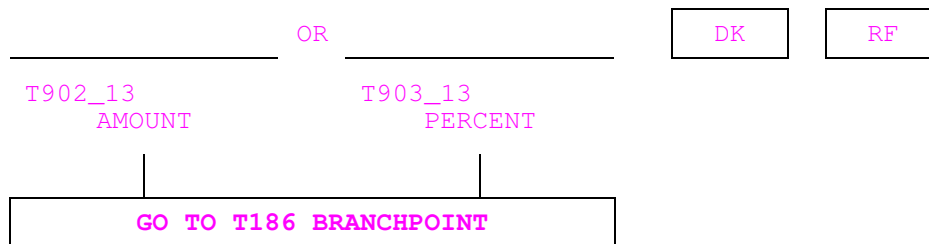

T904\_13

Was it more than half of [his/her] life insurance settlement?

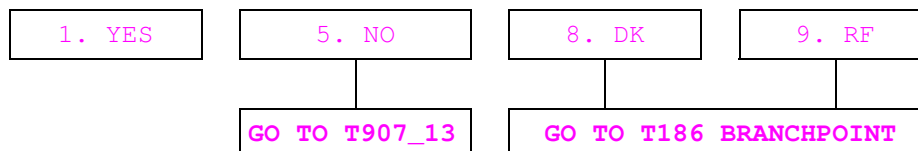

T905\_13

Was it more than 75 percent of [his/her] life insurance settlement?

1. YES	5. NO	8. DK	9. RF
GO TO T186 BRANCHPOINT			

T906\_13

Was it more than 90 percent of [his/her] life insurance settlement?

1. YES	5. NO	8. DK	9. RF
GO TO T186 BRANCHPOINT			

T907\_13

Was it more than 25 percent of [his/her] life insurance settlement?

1. YES	5. NO	8. DK	9. RF
GO TO T186 BRANCHPOINT		GO TO T186 BRANCHPOINT	

T908\_13

Was it more than 10 percent of [his/her] life insurance settlement?

1. YES	5. NO	8. DK	9. RF
--------	-------	-------	-------

\*\*\*END OF BLOCK\_13: LIFE INSURANCE: AMOUNT TO NON-RELATIVES  
(T902\_13 - T908\_13)

\*\*\*END OF T902\_9 LOOP: LIFE INSURANCE DISPERSAL.  
CONTINUE ON TO T186.

T186 BRANCHPOINT: IF R's SPOUSE/PARTNER WAS SOLE LIFE INSURANCE BENEFICIARY  
(T182=1 ONLY) and A DOLLAR AMOUNT WAS GIVEN (T902\_11 ≥ 0),  
GO TO T190

T186

Altogether, what was the value of the life insurance settlement?

[IWER: DO NOT PROBE DK/RF]

_____	DK	RF
AMOUNT		
GO TO T190		

T187-T189 Unfolding Sequence

Question text: Did it amount to a total of less than \$\_\_\_\_ , more than \$\_\_\_\_ , or what?

PROCEDURES: 3Up1Down, 2Up2Down, 1Up3Down

BREAKPOINTS: \$10,000, \$25,000, \$100,000, \$500,000, \$2,000,000

RANDOM ENTRY POINTS: \$25,000, \$100,000, \$500,000

ENTRY POINT ASSIGNMENT: [1 (\$100,000)] or [2 (\$25,000)] or

[{NOT 1 and NOT 2} (\$500,000)] AT X512

ORDER OF ENTRY POINT ASSIGNMENTS AND PROCEDURES CORRESPOND

!! EXIT HEALTH CARE DECISIONS

T190

Now we wish to ask some questions about healthcare decisions toward the end of R's FIRST NAME's life.

Did R's FIRST NAME provide written instructions about the treatment or care [he/she] wanted to receive during the final days of [his/her] life?

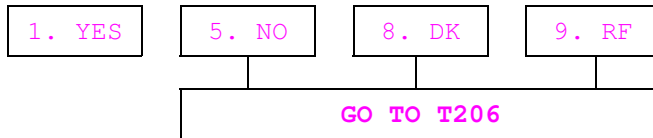

T191

About when were these written instructions dated (approximately)?

T191

MONTH:

01. JAN	02. FEB	03. MAR	04. APR	05. MAY	06. JUN	07. JUL
08. AUG	09. SEP	10. OCT	11. NOV	12. DEC	98. DK	99. RF

\_\_\_\_\_

DK	RF
----	----

T192

YEAR

T193

	1. YES	5. NO	8. DK	9. RF
T193 Did these instructions express a desire to receive all care possible under any circumstances in order to prolong life?				
T194 Did these instructions express a desire to limit care in certain situations?				
T195 Did these instructions express a desire to have any treatment withheld?				
T196 (Did these instructions express a desire to) keep [him/her] comfortable and pain free but to forego extensive measures to prolong life?				

T197

Were these instructions applicable to the actual situation?

1. YES	5. NO	8. DK	9. RF
GO TO T206			

**!! EXIT WHO CONSULTED ON HEALTH CARE DECISIONS**

T198

Were you consulted about whether these instructions should be followed?

1. YES	5. NO	8. DK	9. RF
--------	-------	-------	-------

T199

Were any (other) family members or other persons consulted?

1. YES	5. NO	8. DK	9. RF
GO TO T204			

T200

Who was consulted, (that is, what was their relationship to *R's FIRST NAME*)?

[IWER: CHOOSE ALL THAT APPLY]

Anyone else?

1. DECEASED R	2. NON-SPOUSE/PARTNER PROXY RESPONDENT	3. SPOUSE/ PARTNER	4. CHILD/CHILD-IN-LAW/ GRANDCHILD	
5. OTHER RELATIVE	6. FRIEND	7. PHYSICIAN/HEALTHCARE PROFESSIONAL	8. MINISTER/RABBI/PRIEST/ RELIGIOUS ADVISOR	
9. ATTORNEY	10. SOCIAL WORKER	97. OTHER (SPECIFY) _____	98. DK	99. RF
T201				

T202 BRANCHPOINT: IF PROXY DID NOT REPORT THAT A CHILD/GRANDCHILD WAS CONSULTED (T200 NOT 4), GO TO T204

T202/T060\_T202

(Which child was that?)

IF GRANDCHILD:

(Which child is the parent of that grandchild?)

[IWER: CHOOSE ALL THAT APPLY]

CHILD NAME(S) [DISPLAYED BY BLAISE FROM PREVIOUS RESPONSES]
3. THROUGH 52. CHILD NAME(S)  [ROWS PROVIDED BY BLAISE AS NECESSARY]
92. DECEASED CHILD
93. ALL CHILDREN
97. OTHER (SPECIFY) [T203]
98. DK
99. RF

NOTE: NAMES OF ALL LIVING AND DEAD CHILDREN ARE DISPLAYED. NAMES OF SPOUSE/PARTNERS OF CHILDREN ARE NOT DISPLAYED.

T204

Did any problems come up in trying to follow these written instructions?

1. YES	5. NO	8. DK	9. RF
GO TO T206			

T205

Did the physician or any other health care worker have problems following the written instructions?

1. YES	5. NO	8. DK	9. RF
--------	-------	-------	-------

T206

Did R's FIRST NAME (also) make any legal arrangements for a specific person or persons to make decisions about [his/her] care or medical treatment if [he/she] could not make those decisions [himself/herself]? This is sometimes called a Durable Power of Attorney for Health Care.

1. YES	5. NO	8. DK	9. RF
GO TO T213			

T207

Who had that authority, (that is, what was their relationship to R's FIRST NAME)?



[IWER: CHOOSE ALL THAT APPLY]

1. DECEASED R	2. NON-SPOUSE/PARTNER PROXY RESPONDENT	3. SPOUSE/ PARTNER	4. CHILD/CHILD-IN-LAW/ GRANDCHILD
5. OTHER RELATIVE	6. FRIEND	7. PHYSICIAN/HEALTHCARE PROFESSIONAL	8. MINISTER/RABBI/PRIEST/ RELIGIOUS ADVISOR
9. ATTORNEY	10. SOCIAL WORKER	97. OTHER (SPECIFY) _____	98. DK
		T208	99. RF

T209 BRANCHPOINT: IF PROXY DID NOT REPORT THAT A CHILD/GRANDCHILD WAS CONSULTED (T207 NOT 4), GO TO T211

T209/T061\_T209

(Which child was that?)

IF GRANDCHILD:

(Which child is the parent of that grandchild?)

[IWER: CHOOSE ALL THAT APPLY]

CHILD NAME(S) [DISPLAYED BY BLAISE FROM PREVIOUS RESPONSES]
3. THROUGH 52. CHILD NAME(S)
[ROWS PROVIDED BY BLAISE AS NECESSARY]
92. DECEASED CHILD
93. ALL CHILDREN
97. OTHER (SPECIFY) [T210]
98. DK
99. RF

NOTE: NAMES OF ALL LIVING AND DEAD CHILDREN ARE DISPLAYED. NAMES OF SPOUSE/PARTNERS OF CHILDREN ARE NOT DISPLAYED.

T211

When was the Durable Power of Attorney for Health Care made (approximately)?

T211

MONTH:

01. JAN	02. FEB	03. MAR	04. APR	05. MAY	06. JUN	07. JUL
08. AUG	09. SEP	10. OCT	11. NOV	12. DEC	98. DK	99. RF

\_\_\_\_\_  DK  RF

T212

YEAR

T213

Did *R's FIRST NAME* ever discuss with you or anyone else the treatment or care [he/she] wanted to receive in the final days of [his/her] life?

1. YES	5. NO	8. DK	9. RF
GO TO T218			

T214

With whom did [he/she] discuss it, (that is, what was their relationship to *R's FIRST NAME*)?

[IWER: CHOOSE ALL THAT APPLY]

2. NON-SPOUSE/PARTNER PROXY RESPONDENT	3. SPOUSE/PARTNER	4. CHILD/CHILD-IN-LAW/ GRANDCHILD		
5. OTHER RELATIVE	6. FRIEND	7. PHYSICIAN/HEALTHCARE PROFESSIONAL	8. MINISTER/RABBI/PRIEST/ RELIGIOUS ADVISOR	
9. ATTORNEY	10. SOCIAL WORKER	97. OTHER (SPECIFY) _____ T215	98. DK	99. RF

T216 BRANCHPOINT: IF PROXY DID NOT REPORT THAT A CHILD/GRANDCHILD WAS CONSULTED (T214 NOT 4), GO TO T218

T216/T062\_T216

(Which child was that?)

IF GRANDCHILD:

(Which child is the parent of that grandchild?)

[IWER: CHOOSE ALL THAT APPLY]

CHILD NAME(S) [DISPLAYED BY BLAISE FROM PREVIOUS RESPONSES]
3. THROUGH 52. CHILD NAME(S)  [ROWS PROVIDED BY BLAISE AS NECESSARY]
92. DECEASED CHILD
93. ALL CHILDREN
97. OTHER (SPECIFY) [T217]
98. DK
99. RF

NOTE: NAMES OF ALL LIVING AND DEAD CHILDREN ARE DISPLAYED. NAMES OF SPOUSE/PARTNERS OF CHILDREN ARE NOT DISPLAYED.

T218

Did any decisions have to be made about the care and treatment of R's FIRST NAME during the final days of [his/her] life?

1. YES	5. NO	8. DK	9. RF
GO TO T237			

T219

Who was actually involved in making decisions about the care and treatment of R's FIRST NAME during the final days of [his/her] life, (that is, what was their relationship to R's FIRST NAME)?

(Who else participated?)

[IWER: CHOOSE ALL THAT APPLY]

1. DECEASED R	2. NON-SPOUSE/PARTNER PROXY RESPONDENT	3. SPOUSE/ PARTNER	4. CHILD/CHILD-IN-LAW/ GRANDCHILD
5. OTHER RELATIVE	6. FRIEND	7. PHYSICIAN/HEALTHCARE PROFESSIONAL	8. MINISTER/RABBI/PRIEST/ RELIGIOUS ADVISOR
9. ATTORNEY	10. SOCIAL WORKER	97. OTHER (SPECIFY) _____ T220	98. DK
			99. RF

T221 BRANCHPOINT: IF PROXY DID NOT REPORT THAT A CHILD/GRANDCHILD WAS CONSULTED (T219 NOT 4), GO TO T223 BRANCHPOINT

T221/T063\_T221

(Which child was that?)

IF GRANDCHILD:

(Which child is the parent of that grandchild?)

[IWER: CHOOSE ALL THAT APPLY]

CHILD NAME(S) [DISPLAYED BY BLAISE FROM PREVIOUS RESPONSES]
3. THROUGH 52. CHILD NAME(S) [ROWS PROVIDED BY BLAISE AS NECESSARY]
92. DECEASED CHILD
93. ALL CHILDREN
97. OTHER (SPECIFY) [T222]
98. DK
99. RF

NOTE: NAMES OF ALL LIVING AND DEAD CHILDREN ARE DISPLAYED. NAMES OF SPOUSE/PARTNERS OF CHILDREN ARE NOT DISPLAYED.

T223 BRANCHPOINT: IF DECEASED R WAS AMONG THOSE CONSULTED (T219=1), GO TO T227 BRANCHPOINT

T223

Was R's FIRST NAME able to participate in decisions about [his/her] medical care during the final days of [his/her] life?

1. YES	5. NO	8. DK	9. RF
GO TO T227 BRANCHPOINT		GO TO T227 BRANCHPOINT	

T224

For about how long before R's FIRST NAME died was [he/she] unable to participate in decisions about [his/her] medical care?

_____	OR	_____	OR	_____	DK	RF
T224 MONTHS		T225 DAYS		T226 YEAR		

T227 BRANCHPOINT: IF AT LEAST TWO {PEOPLE OR CATEGORY OF PERSON} PARTICIPATED IN THE DECISIONS ({BETWEEN QUESTIONS T219 AND T221} AND T223=1} see NOTE, below), CONTINUE ON TO T227 OTHERWISE, GO TO T230

NOTE: "AT LEAST TWO {PEOPLE OR CATEGORY OF PERSONS}" CAN BE  
 (a) NUMBER OF SELECTIONS AT {T219 or T221} > 1, or  
 (b) SELECTION OF {"1. DECEASED R( AT T219 or T223=1} IN ADDITION TO ONE OTHER SELECTION AT T219, or  
 (c) MORE THAN ONE CHILD SELECTED AT T221, WHICH CAN INCLUDE (92. DECEASED CHILD(, or  
 (d) SELECTION OF (93. ALL CHILDREN( AT T221.

T227

Who was the main decision-maker (that is, what was their relationship to R's FIRST NAME)?

1. DECEASED R	2. NON-SPOUSE/PARTNER PROXY RESPONDENT	3. SPOUSE/ PARTNER	4. CHILD/CHILD-IN-LAW/ GRANDCHILD
5. OTHER RELATIVE	6. FRIEND	7. PHYSICIAN/HEALTHCARE PROFESSIONAL	8. MINISTER/RABBI/PRIEST/ RELIGIOUS ADVISOR
9. ATTORNEY	10. SOCIAL WORKER	97. OTHER (SPECIFY) _____ T244	98. DK
			99. RF

NOTE: RESPONSE "1. DECEASED R" APPEARS ONLY IF PROXY SAID R WAS ABLE TO PARTICIPATE IN HIS/HER OWN DECISIONS (T223=1).

T228 BRANCHPOINT: IF PROXY DID NOT REPORT THAT A CHILD/GRANDCHILD WAS CONSULTED (T227 NOT 4), GO TO T230

IF {PROXY GAVE ONLY 1 RESPONSE TO T221 *and* THAT RESPONSE WAS NOT "ALL CHILDREN" (T221 NOT 93)}, GO TO T230

T228/T243\_T228

(Which child was that?)

IF GRANDCHILD:

(Which child is the parent of that grandchild?)

CHILD NAME(S) [DISPLAYED BY BLAISE FROM PREVIOUS RESPONSES]
3. THROUGH 52. CHILD NAME(S)
[ROWS PROVIDED BY BLAISE AS NECESSARY]
92. DECEASED CHILD
97. OTHER (SPECIFY) [T229]
98. DK
99. RF

NOTE: NAMES OF ALL LIVING AND DEAD CHILDREN ARE DISPLAYED. NAMES OF SPOUSE/PARTNERS OF CHILDREN ARE NOT DISPLAYED.

**!! EXIT TYPE OF HEALTH CARE DECISIONS**

T230

Did those last decisions involve a desire to give all care possible unconditionally in order to prolong life?

1. YES	5. NO	8. DK	9. RF
--------	-------	-------	-------

T231

Did those last decisions involve limiting care in certain situations?

1. YES	5. NO	8. DK	9. RF
--------	-------	-------	-------

T232

Did those last decisions involve withholding any treatment?

1. YES	5. NO	8. DK	9. RF
--------	-------	-------	-------

T233

Did those last decisions rest largely on keeping *R's FIRST NAME* comfortable and pain free without taking extensive measures to prolong life?

1. YES	5. NO	8. DK	9. RF
--------	-------	-------	-------

T234

Did any doctor(s) recommend any care or treatment that the family or other decision-maker(s) ultimately refused?

1. YES	5. NO	8. DK	9. RF
GO TO T236			

T235

Did *R's FIRST NAME* receive this treatment anyway?

1. YES	5. NO	8. DK	9. RF
--------	-------	-------	-------

T236

Did cost enter into the decisions about what care or treatment [he/she] would receive in the final days of [his/her] life?

1. YES	5. NO	8. DK	9. RF
--------	-------	-------	-------

T237

Thinking back over the course of *R's FIRST NAME's* life, what would you say were [his/her] greatest strengths?

	DK	RF

IF THIS IS A CORE INTERVIEW, GO TO SECTION U

IF THIS IS AN EXIT INTERVIEW, GO TO MODULES