

\*\*\*\*\*

NOTE ABOUT BRANCHPOINTS:

WHERE THERE IS MORE THAN ONE JUMP WITHIN A BRANCHPOINT BOX, THE JUMPS ARE TO BE APPLIED IN ORDER FROM THE TOP.

\*\*\*\*\*

NOTE ABOUT COLORS:

ALL QUESTION TEXT IN BLACK IS FOR THE CORE INTERVIEW.

ALL QUESTION TEXT IN FUCHSIA IS FOR THE EXIT INTERVIEW. ALSO IN FUCHSIA IS ALL OTHER TEXT THAT IS SPECIFIC TO THE EXIT INTERVIEW BUT NOT TO THE CORE.

OTHERWISE, BLACK TEXT FOR CODEFRAMES, INTERVIEWER INSTRUCTIONS, JUMPS AND BRANCHPOINTS, ETC. CAN APPLY TO BOTH THE CORE AND THE EXIT INTERVIEW UNLESS SPECIFIED OTHERWISE OR THERE IS AN EXIT ALTERNATIVE.

ON A BLACK-AND-WHITE HARD COPY OF THE DOCUMENT, THE FUCHSIA TEXT WILL APPEAR SOMEWHAT LIGHTER THAN THE ORIGINAL BLACK.

\*\*\*\*\*

NOTE ABOUT EXIT INTERVIEW Rs:

ANY NEW SPOUSE/PARTNER THAT AN EXIT INTERVIEW R ACQUIRED SINCE HIS/HER LAST INTERVIEW IS IGNORED FOR THE PURPOSES OF THIS INTERVIEW.

\*\*\*\*\*

MAJOR FLOW CONTROL, CONDITION AND FILL VARIABLES \*

SELF INTERVIEW (A009=1);  
PROXY INTERVIEW (A009={2 or 3})

R IS MARRIED (X065=1);  
R IS PARTNERED (X065=3);  
R IS SINGLE (X065=6)

R's LAST IW MONTH (per Z092), YEAR (per Z093) = R's LAST IW DATE

R's FIRST NAME (per X058)

R's LAST IW EMPLOYER NAME (per Z091)

R's LAST IW TITLE (per Z128)

-----

\* A variable fieldname and code reference is shown at its first occurrence in the questionnaire, but in some cases, especially when it is common, is not shown after that.

\*\*\*\*\*

\*\*\*\*\*

**NOTE: QUESTIONS FOR THE EXIT INTERVIEW BEGIN WITH J023**

\*\*\*\*\*

J023 BRANCHPOINT: IF THIS IS AN EXIT INTERVIEW *and* R WAS NOT WORKING AT R's LAST IW (Z123 NOT 1), GO TO SECTION N

IF THIS IS AN EXIT INTERVIEW *and* R WAS NOT SELF-EMPLOYED AT LAST IW (Z136 NOT 2), GO TO J063

IF R IS CURRENTLY WORKING FOR SOMEONE ELSE (J021=1) *and* WAS WORKING FOR SOMEONE ELSE AT R's LAST IW (Z136=1), GO TO J045

IF R DID NOT REPORT THAT IS CURRENTLY WORKING FOR SOMEONE ELSE ({J020 *and* J021} NOT 1) *and* WAS WORKING FOR SOMEONE ELSE AT R's LAST IW (Z136=1), GO TO J063

IF R WAS SELF-EMPLOYED AT R's LAST IW (Z136=2) *and* DID NOT REPORT THAT IS CURRENTLY SELF-EMPLOYED (J021 NOT 2), CONTINUE ON TO J023

OTHERWISE, IF CORE IW, GO TO JW158\_2 BRANCHPOINT

OTHERWISE, IF EXIT IW, GO TO SECTION N

J023

According to our records, in R's LAST IW MONTH (per Z092), YEAR (per Z093) you were self-employed.

In what month and year did you stop working for yourself?

[IWER: MONTH ENTERED MUST BE BETWEEN R's LAST IW MONTH, YEAR AND CURRENT IW MONTH, YEAR.]

Now I have some questions about R's FIRST NAME's (X058) employment before [he/she] died. According to our records, in R's LAST IW MONTH, YEAR [he/she] was self-employed.

In what month and year did [he/she] stop working for [himself/herself]?

[IWER: MONTH ENTERED MUST BE BETWEEN R's LAST IW MONTH, YEAR AND R's DATE OF DEATH — MONTH, YEAR.]

J023

MONTH:

1. JAN	2. FEB	3. MAR	4. APR	5. MAY	6. JUN
7. JUL	8. AUG	9. SEP	10. OCT	11. NOV	12. DEC

94. STILL WORKING FOR SELF (AS PRIMARY JOB)

96. STILL WORKING FOR SELF AS SECOND JOB  
EXIT: DOES NOT DISPLAY

GO BACK TO J021 AND CHANGE RESPONSE TO SELF-EMPLOYED (J021=2)

GO TO J028 BRANCHPOINT

97. DENIES BEING SELF-EMPLOYED AT PREVIOUS IW

98. DK

99. RF

GO TO JW158\_2 BRANCHPOINT  
EXIT: DOES NOT DISPLAY

DK

RF

J024

YEAR

J028 BRANCHPOINT: IF THIS IS AN EXIT INTERVIEW, GO TO J031

IF R DID NOT REPORT THAT IS STILL WORKING FOR SELF (AS SECOND  
JOB) (J023 NOT 96), GO TO J031

J028

Were there any months since [CURRENT IW MONTH, YEAR 2 YEARS AGO/  
R's LAST IW MONTH, YEAR] when you were not working for pay?

1. YES	5. NO	8. DK	9. RF
GO TO JW158_2 BRANCHPOINT			

J029

Which months were those?

[R's PREV WAVE DATE: MONTH, YEAR]

NOTE: MONTH AND YEAR OF R's LAST IW ARE DISPLAYED TO IWER.

[IWER: MONTHS ENTERED MUST BE BETWEEN R's LAST IW MONTH, YEAR AND CURRENT IW MONTH, YEAR]

[IWER: PRESS [F9] AND ARROW DOWNWARD FOR WHOLE YEAR AND OTHER CHOICES, THEN PRESS [ENTER] TO RETURN TO ANSWER BOX]

[IWER: CHOOSE ALL THAT APPLY]

MONTHS IN 2006	MONTHS IN 2007	MONTHS IN 2008	OTHER YEARS
(1) JAN 06	(14) JAN 07	(27) JAN 08	(41) ALL OF 2006 (AFTER PREV IW MO)
(2) FEB 06	(15) FEB 07	(28) FEB 08	(42) ALL OF 2005 (AFTER PREV IW MO)
(3) MAR 06	(16) MAR 07	(29) MAR 08	(43) ALL OF 2005
(4) APR 06	(17) APR 07	(30) APR 08	(44) ALL OF 2004 (AFTER PREV IW MO)
(5) MAY 06	(18) MAY 07	(31) MAY 08	(45) ALL OF 2004
(6) JUN 06	(19) JUN 07	(32) JUN 08	(46) ALL OF 2003 (AFTER PREV IW MO)
(7) JUL 06	(20) JUL 07	(33) JUL 08	(47) ALL OF 2003
(8) AUG 06	(21) AUG 07	(34) AUG 08	(48) ALL OF 2002 (AFTER PREV IW MO)
(9) SEP 06	(22) SEP 07	(35) SEP 08	(49) ALL OF 2002
(10) OCT 06	(23) OCT 07	(36) OCT 08	(50) ALL OF 2001 (AFTER PREV IW MO)
(11) NOV 06	(24) NOV 07	(37) NOV 08	(51) ALL OF 2001
(12) DEC 06	(25) DEC 07	(38) DEC 08	(52) ALL OF 2000 (AFTER PREV IW MO)
(13) ALL OF 2006	(26) ALL OF 2007	(39) ALL OF 2008 TO DATE	(53) ALL OF 2000
		(40) ALL OF 2008	(54) ALL OF 1999 (AFTER PREV IW MO)
			(55) ALL OF 1999
			(56) ALL OF 1998 (AFTER PREV IW MO)
			(57) ALL OF 1998
			(58) ALL OF 1997 (AFTER PREV IW MO)
			(59) ALL OF 1997
			(60) ALL OF 1996 (AFTER PREV IW MO)
			(61) ALL OF 1996
			(62) ALL OF 1995 (AFTER PREV IW MO)
			(63) ALL OF 1995
			(64) ALL OF 1994 (AFTER PREV IW MO)
			(65) ALL OF 1994
			(66) ALL OF 1993 (AFTER PREV IW MO)
			(67) ALL OF 1993
			(68) ALL OF 1992 (AFTER PREV IW MO)
			(69) OTHER (SPECIFY) [J030]
			(98) DK
			(99) RF

NOTE: THE ONLY CHOICES PRESENTED TO THE IWER ARE THOSE FOR MONTHS AND YEARS FROM R's LAST IW DATE UNTIL CURRENT IW MONTH & YEAR.

J031 BRANCHPOINT: GO TO JW158\_2 BRANCHPOINT

J031

Were you paid a regular salary or wages?

Was [she/he] paid a regular salary or wages?

1. YES	5. NO	8. DK	9. RF
GO TO J038			

J032

How much were you paid before taxes and other deductions?

How much was she/he paid before taxes and other deductions?

[IWER: DO NOT PROBE DK/RF]

[IWER: IF AMOUNT PER HOUR, ENTER BOTH DOLLARS AND CENTS]

	0	DK	RF
AMOUNT			
GO TO J036	GO TO J038		

J033-J035 Unfolding Sequence

Question text: {CORE AND EXIT} Did it amount to a total of less than \$\_\_\_\_ per month, more than \$\_\_\_\_ per month, or what?

PROCEDURES: 2Up1Down, 1Up2Down

BREAKPOINTS: \$625, \$1,500, \$3,000, \$6,500

RANDOM ENTRY POINTS: \$1,500, \$3,000

ENTRY POINT ASSIGNMENT: 1 OR {NOT 1} AT X510

ORDER OF ENTRY POINT ASSIGNMENTS AND PROCEDURES CORRESPOND

J036 BRANCHPOINT: GO TO J038

J036

{CORE AND EXIT} [IWER: PROBE IF NECESSARY]

Was that per hour, week, month, or year?

PER:

1. HOUR	2. WEEK	3. EVERY TWO WEEKS/BI-WEEKLY	4. MONTH	5. TWICE A MONTH
6. YEAR	7. OTHER (SPECIFY) _____ J037		8. DK	9. RF

J038

Did you receive some or all of the net earnings or profits?

Did [she/he] receive some or all of the net earnings or profits?

DEFINITION: NET EARNING OR PROFIT IS TOTAL BUSINESS INCOMES LESS TOTAL BUSINESS EXPENSES.

1. YES	5. NO	8. DK	9. RF
GO TO J073 BRANCHPOINT			

J039

(In addition to your regular salary,) How much did you receive from net earnings or profits?



[IWER: IF R HAS TROUBLE GIVING DOLLAR FIGURE, ASK:]  
 What did you earn the last year you worked?

(In addition to [her/his] regular salary,) How much did [she/he] receive from net earnings or profits?

[IWER: IF PROXY HAS TROUBLE GIVING DOLLAR FIGURE, ASK:]  
 What did [she/he] earn the last year [she/he] worked?

DEFINITION: NET EARNING OR PROFIT IS TOTAL BUSINESS INCOMES LESS TOTAL BUSINESS EXPENSES.

[IWER: DO NOT PROBE DK/RF]

[IWER: IF AMOUNT PER HOUR, ENTER BOTH DOLLARS AND CENTS]

	0	DK	RF
AMOUNT			
GO TO J043	GO TO J073 BRANCHPOINT		

J040-J042 Unfolding Sequence

Question text: {CORE AND EXIT} Did it amount to a total of less than \$\_\_\_ per year, more than \$\_\_\_ per year, or what?

PROCEDURES: 2Up1Down, 1Up2Down  
 BREAKPOINTS: \$3,300, \$10,000, \$30,000, \$75,000  
 RANDOM ENTRY POINTS: \$10,000, \$30,000  
 ENTRY POINT ASSIGNMENT: 1 OR {NOT 1} AT X501  
 ORDER OF ENTRY POINT ASSIGNMENTS AND PROCEDURES CORRESPOND

J043 BRANCHPOINT: GO TO J073 BRANCHPOINT

J043  
 {CORE AND EXIT} [IWER: PROBE IF NECESSARY]  
 Was that per hour, week, month, or year?  
 PER:

1. HOUR	2. WEEK	3. EVERY TWO WEEKS/BI-WEEKLY	4. MONTH	5. TWICE A MONTH
6. YEAR	7. OTHER (SPECIFY) _____ J044	8. DK	9. RF	

J045 BRANCHPOINT: GO TO J073 BRANCHPOINT

J045  
 According to our records, in R's LAST IW MONTH, YEAR you were [working for R's LAST IW EMPLOYER NAME (per Z091)/also working for someone else].

Are you still working there?

[IWER: IF NO PREVIOUS WAVE EMPLOYER NAME APPEARS AND R HAD MORE THAN ONE JOB, WE ARE INTERESTED IN RS MAIN JOB.]

[IWER: IF THERE HAS BEEN MERGER AND ACQUISITION USE CODE 3 OR 4]

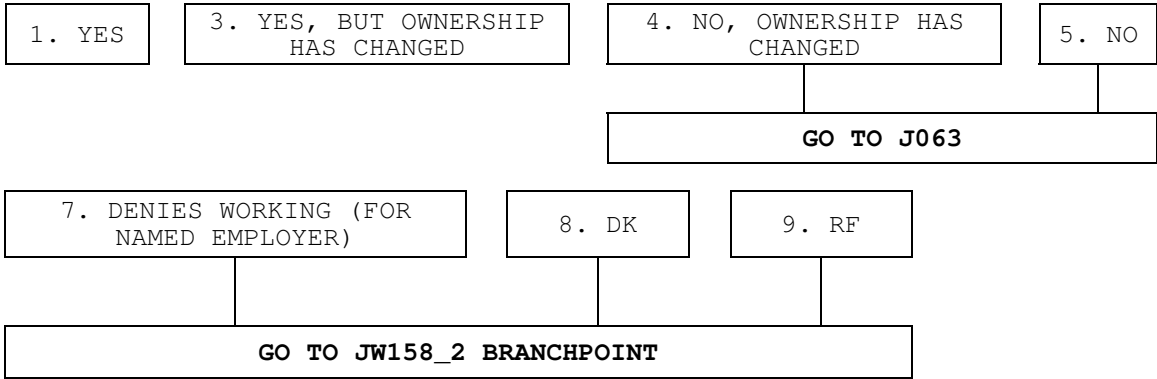

BEGINNING OF **EMPLOYER INFORMATION BLOCK-1:**

(JW168\_1 — JW165\_1)

THE FOLLOWING SERIES OF EMPLOYER NAME AND ADDRESS QUESTIONS (JW168\_1 THROUGH JW165\_1) IS REPLICATED FURTHER ON IN SECTION J (JW158\_2 - JW165\_2) AND ALSO IN SECTION K (KW158\_3 - KW165\_3) AND SECTION L (LW158\_4 - LW165\_4) AND IS KNOWN AS THE SECTION J EMPLOYER NAME BLOCK. QUESTION NUMBERS WITHIN THE EMPLOYER NAME BLOCK ARE W158 - W165, PRECEDED BY THE SECTION NAME, J, AND FOLLOWED BY "\_1" WHICH INDICATES THAT THIS IS THE FIRST TIME THE EMPLOYER NAME BLOCK HAS OCCURRED WITHIN THE QUESTIONNAIRE. QUESTION JW168 OCCURS ONLY IN THIS FIRST OCCURRENCE OF THE EMPLOYER INFORMATION BLOCK, BELOW.

JW168\_1 BRANCHPOINT: IF WE DO NOT KNOW EMPLOYER NAME FROM R's LAST IW (Z091=EMPTY), GO TO JW158\_1

JW168\_1

Is the correct name of your employer R's LAST IW EMPLOYER NAME?

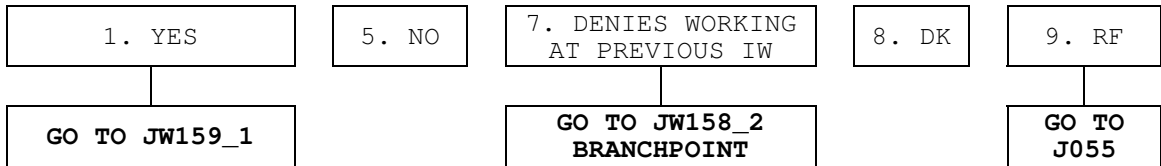

JW158\_1 BRANCHPOINT: IF R SAID NAME OF LAST IW's EMPLOYER {IS INCORRECT or DON'T KNOW} (JW168\_1={5 or 8}), CONTINUE ON TO J158\_1  
  
IF THE ALTERNATE WAVE FLAG IS NOT SET TO ASK QUESTIONS (J731>0), GO TO J055

NOTE: QUESTIONS J158\_1 THROUGH J165\_1 ARE ALWAYS ASKED OF REINTERVIEW Rs WHO WORK FOR THE SAME EMPLOYER AS AT R's LAST IW (J045={1 or 3}), BUT FOR WHOM WE DO NOT KNOW THE EMPLOYER'S NAME (Z091=EMPTY), OR IF S/HE REPORTS THAT THE NAME WE HAVE FOR HIS/HER LAST IW EMPLOYER IS INCORRECT OR S/HE DOESN'T KNOW THE NAME (JW168\_1={5 or 8}).  
IN ADDITION, ALL OTHER REINTERVIEW R's WHO WORK FOR THE SAME EMPLOYER AS AT R's LAST IW WILL BE ASKED THIS SERIES IN 2010 AND EVERY 3<sup>RD</sup> WAVE THEREAFTER (E.G., IN 2016); THEY WERE LAST ASKED IN 2004. **THESE Rs WILL NOT BE ASKED IN 2008.**

JW158\_1

IWER: READ TO ALL RESPONDENTS:

We would like to obtain complete information about fringe benefits for employees like you. In order to do this, we need the full name and address of your employer.

For whom do you work [on your main job/now]?

What is the (company's/organization's) name?

	DK	RF
COMPANY NAME	GO TO J055	

JW159\_1

IF R WORKS FOR SAME EMPLOYER AS R'S LAST IW (J045={1 or 3}) and WE KNOW EMPLOYER NAME FROM LAST IW (Z091 NOT EMPTY):

We would like to obtain complete information about fringe benefits for employees like you. In order to do this, we need the full address of your employer.

ASK ALL Rs:

What is the address of the place where you work(ed)?

[IWER: PROBE IF NECESSARY]

I will need the mailing address, city, state, and zip code.

	DK	RF
ADDRESS 1	GO TO JW161_1	GO TO J055

	DK	RF
JW160_1 ADDRESS 2		

	DK	RF
JW161_1 CITY	GO TO J055	

	97. OTHER (SPECIFY) <hr style="width: 80%; margin: 0;"/> JW163_1 OTHER COUNTRY	98. DK	99. RF
JW162_1 STATE		GO TO J055	

NOTE: THE IWER SELECTS FROM A MENU OF STATE NAMES, INCLUDING WASHINGTON, D.C., AND PUERTO RICO.

DK	RF
----	----

JW164\_1  
ZIP

[IWER: DO NOT USE DASH IN PHONE NUMBER]

[IWER: ENTER 999 FOR UNKNOWN AREA CODE OR NUMBER]

DK

RF

JW165\_1  
PHONE NUMBER

END OF **EMPLOYER INFORMATION BLOCK-1:**

(JW168\_1 — JW165\_1)

J055

Were there any months since [*CURRENT IW MONTH, YEAR 2 YEARS AGO/R's LAST IW MONTH, YEAR*] when you did not work for [*R's LAST IW EMPLOYER NAME (per Z091)/R's CURRENT EMPLOYER NAME (per J046)/that employer*]?

1. YES

5. NO

8. DK

9. RF

GO TO J058 BRANCHPOINT

J056

Which months were those?

[IWER: MONTHS ENTERED MUST BE BETWEEN R's LAST IW MONTH, YEAR AND CURRENT IW MONTH, YEAR]

[IWER: PRESS [F9] AND ARROW DOWNWARD FOR WHOLE YEAR AND OTHER CHOICES, THEN PRESS [ENTER] TO RETURN TO ANSWER BOX]

[IWER: CHOOSE ALL THAT APPLY]

MONTHS IN 2006	MONTHS IN 2007	MONTHS IN 2008	OTHER YEARS
(1) JAN 06	(14) JAN 07	(27) JAN 08	(41) ALL OF 2006 (AFTER PREV IW MO)
(2) FEB 06	(15) FEB 07	(28) FEB 08	(42) ALL OF 2005 (AFTER PREV IW MO)
(3) MAR 06	(16) MAR 07	(29) MAR 08	(43) ALL OF 2005
(4) APR 06	(17) APR 07	(30) APR 08	(44) ALL OF 2004 (AFTER PREV IW MO)
(5) MAY 06	(18) MAY 07	(31) MAY 08	(45) ALL OF 2004
(6) JUN 06	(19) JUN 07	(32) JUN 08	(46) ALL OF 2003 (AFTER PREV IW MO)
(7) JUL 06	(20) JUL 07	(33) JUL 08	(47) ALL OF 2003
(8) AUG 06	(21) AUG 07	(34) AUG 08	(48) ALL OF 2002 (AFTER PREV IW MO)
(9) SEP 06	(22) SEP 07	(35) SEP 08	(49) ALL OF 2002
(10) OCT 06	(23) OCT 07	(36) OCT 08	(50) ALL OF 2001 (AFTER PREV IW MO)
(11) NOV 06	(24) NOV 07	(37) NOV 08	(51) ALL OF 2001
(12) DEC 06	(25) DEC 07	(38) DEC 08	(52) ALL OF 2000 (AFTER PREV IW MO)
(13) ALL OF 2006	(26) ALL OF 2007	(39) ALL OF 2008 TO DATE	(53) ALL OF 2000
		(40) ALL OF 2008	(54) ALL OF 1999 (AFTER PREV IW MO)
			(55) ALL OF 1999
			(56) ALL OF 1998 (AFTER PREV IW MO)
			(57) ALL OF 1998
			(58) ALL OF 1997 (AFTER PREV IW MO)
			(59) ALL OF 1997
			(60) ALL OF 1996 (AFTER PREV IW MO)
			(61) ALL OF 1996
			(62) ALL OF 1995 (AFTER PREV IW MO)
			(63) ALL OF 1995
			(64) ALL OF 1994 (AFTER PREV IW MO)
			(65) ALL OF 1994
			(66) ALL OF 1993 (AFTER PREV IW MO)
			(67) ALL OF 1993
			(68) ALL OF 1992 (AFTER PREV IW MO)
			(69) OTHER (SPECIFY) [J057]
			(98) DK
			(99) RF

NOTE: THE ONLY CHOICES PRESENTED TO THE IWER ARE THOSE FOR MONTHS AND YEARS FROM R's LAST IW DATE UNTIL CURRENT IW MONTH & YEAR.

J058 BRANCHPOINT: IF WE DO NOT HAVE JOB TITLE FROM R's LAST IW (Z128=EMPTY),  
GO TO J166 BRANCHPOINT

J058

In R's LAST IW MONTH, YEAR our records indicate that your job title was R's LAST IW TITLE.

Is this still the case?

[IWER: IF JOB TITLE IS SLIGHTLY INACCURATE BUT DESCRIBES R's CURRENT JOB, ANSWER "YES" HERE AND NOTE CORRECTIONS AS A COMMENT.]

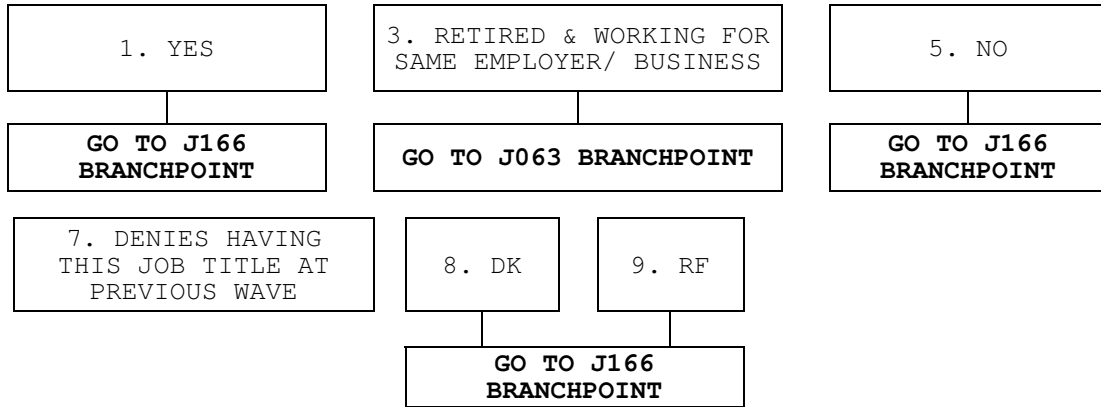

J059

What was your job title in [CURRENT IW MONTH, YEAR 2 YEARS AGO/R's LAST IW MONTH, YEAR]?

[IWER: PROBE:]  
The title that your employer used?

\_\_\_\_\_

TITLE

DK

RF

J060

What sort of work did you do?

[IWER: PROBE:]

Tell me a little more about what you did.

\_\_\_\_\_  DK  RF  
\_\_\_\_\_  
\_\_\_\_\_  
\_\_\_\_\_  
\_\_\_\_\_

J061

What is your job title now?

[IWER: PROBE:]

The title that your employer uses?

\_\_\_\_\_  DK  RF  
TITLE

J062

What sort of work do you do now?

[IWER: PROBE:]

Tell me a little more about what you do.

\_\_\_\_\_  DK  RF  
\_\_\_\_\_  
\_\_\_\_\_  
\_\_\_\_\_  
\_\_\_\_\_

J063 BRANCHPOINT: IF R DENIES HAVING PREVIOUSLY LISTED JOB TITLE AT R's LAST  
IW (J058=7), GO TO J169  
  
IF R REPORTED RETIRED AND WORKING FOR SAME EMPLOYER (J058=3)  
and GAVE YEAR S/HE RETIRED AT J018, GO TO J067 BRANCHPOINT



J063

IF {R WAS WORKING IN LAST IW AND NOW IS {RETIRED AND WORKING FOR SAME EMPLOYER/BUSINESS}} (J058=3) and YEAR RETIRED WAS NOT REPORTED (J018 NOT ASKED):

In what month and year did you retire?

IF R IS NO LONGER WORKING FOR R's LAST IW EMPLOYER (J045={4 or 5}):

In what month and year did you stop working there?

IF NAME OF R's LAST IW EMPLOYER IS KNOWN (Z091 NOT EMPTY):

According to our records, you were working for R's LAST IW EMPLOYER NAME (per Z091) in R's LAST IW MONTH, YEAR.

In what month and year did you stop working there?

OTHERWISE:

According to our records, you were working for someone else when we last talked to you in R's LAST IW MONTH, YEAR.

In what month and year did you stop working for that employer?

[IWER: MONTH ENTERED MUST BE BETWEEN R's LAST IW MONTH, YEAR AND CURRENT IW MONTH, YEAR]

Now I have some questions about R's FIRST NAME's employment before [he/she] died.

IF R'S LAST IW EMPLOYER IS KNOWN (Z091 NOT EMPTY):

According to our records, [he/she] was working for R's LAST IW EMPLOYER NAME (per Z091) in R's LAST IW MONTH, YEAR.

In what month and year did [he/she] stop working there, or was [he/she] still working there when [he/she] died?

OTHERWISE:

According to our records, [he/she] was working for someone else when we last talked to [him/her] in R's LAST IW MONTH, YEAR.

In what month and year did [he/she] stop working for that employer?

[IWER: MONTH ENTERED MUST BE BETWEEN R's LAST IW MONTH, YEAR AND R's DATE OF DEATH, MONTH, YEAR.]

J063

MONTH:

1. JAN	2. FEB	3. MAR	4. APR	5. MAY	6. JUN
7. JUL	8. AUG	9. SEP	10. OCT	11. NOV	12. DEC

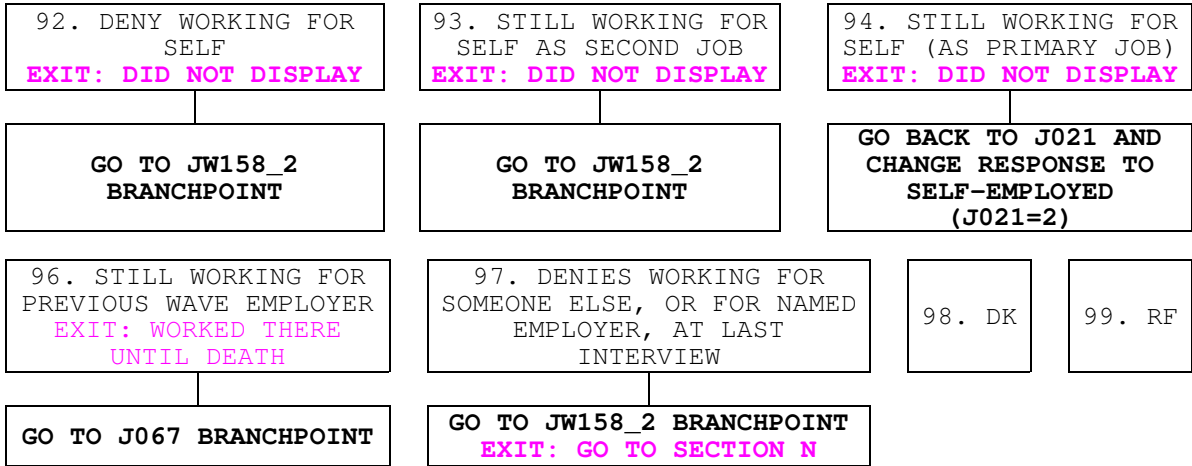

NOTE: WHEN R REPORTED EARLIER THAT WAS RETIRED AND WORKING FOR THE SAME EMPLOYER (J058=3), CODE "96. STILL WORKING FOR PREVIOUS WAVE EMPLOYER" DOES NOT APPEAR IN THIS CODEFRAME.

\_\_\_\_\_

DK	RF
----	----

J064  
YEAR

J067 BRANCHPOINT: IF R IS SELF-EMPLOYED (J021=2) and SAID THAT IS STILL WORKING FOR PREVIOUS WAVE EMPLOYER (J063=96), GO BACK TO J021 AND CHANGE RESPONSE TO SOMEONE ELSE (J021=1)

IF R IS SELF-EMPLOYED (J021=2) and SAID THAT IS STILL WORKING FOR SELF AS PRIMARY JOB (J063=94), GO TO J166 BRANCHPOINT

IF R SAID STILL WORKING FOR LAST IW EMPLOYER (J063=96) and DID NOT REPORT THAT IS {RETIRED AND WORKING FOR SAME EMPLOYER/BUSINESS} (J058 NOT 3) and R WAS ASKED J045 (J045 NOT EMPTY), GO BACK TO J045 AND CHANGE RESPONSE TO YES (J045=1)

IF R REPORTED OWNERSHIP OF PREVIOUS EMPLOYER HAS CHANGED BUT R NOW WORKS FOR SOMEONE ELSE (J045=4), GO TO J083 BRANCHPOINT

J067

IF R WAS WORKING IN LAST IW (Z123=1) and NOW IS {RETIRED AND WORKING FOR SAME EMPLOYER/BUSINESS (J058=3)}:  
 What were you earning, before deductions, when you retired?

OTHERWISE:

What were you earning, before deductions, when you left that employer?

What was [he/she] earning, before deductions, [when [he/she] left that employer/at the time of [his/her] death]?

[IWER: IF AMOUNT PER HOUR, ENTER BOTH DOLLARS AND CENTS]

[IWER: DO NOT PROBE DK/RF]

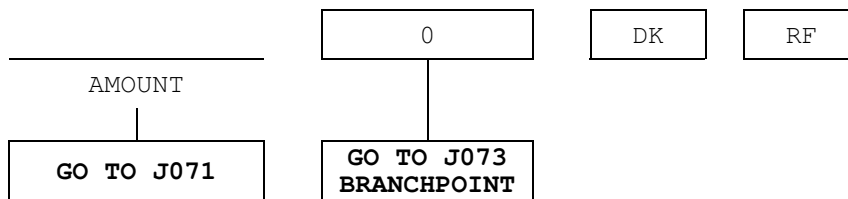

J068-J070 Unfolding Sequence

Question text: {CORE AND EXIT} Did it amount to a total of less than \$\_\_\_ per month, more than \$\_\_\_ per month, or what?

PROCEDURES: 2Up1Down, 1Up2Down

BREAKPOINTS: \$200, \$800, \$1,500, \$3,000

RANDOM ENTRY POINTS: \$800, \$1,500

ENTRY POINT ASSIGNMENT: 1 OR {NOT 1} AT X502

ORDER OF ENTRY POINT ASSIGNMENTS AND PROCEDURES CORRESPOND

J071 BRANCHPOINT: GO TO J073 BRANCHPOINT

J071

{CORE AND EXIT} [IWER: PROBE IF NECESSARY]

Was that per hour, week, month, or year?

PER:

1. HOUR	2. WEEK	3. EVERY TWO WEEKS/BI-WEEKLY	4. MONTH	5. TWICE A MONTH
6. YEAR	7. OTHER (SPECIFY) _____ J072	8. DK	9. RF	

J073 BRANCHPOINT: IF R IS {RETIRED AND WORKING FOR SAME EMPLOYER/BUSINESS} (J058=3), GO TO J080 BRANCHPOINT

IF THIS IS AN EXIT INTERVIEW, GO TO J084 BRANCHPOINT

J073

IF NOT SELF-EMPLOYED AT LAST IW (Z136=1):  
Why did you leave that employer?

(Did the business close, were you laid off or let go, did you have poor health or a disability, did you leave to take care of family members, did you quit, did you retire, did ownership of your employment change, did your pension rules change, or what?)

IF SELF-EMPLOYED AT LAST IW (Z136=2):  
Why did you stop working at that business?

[IWER: DO NOT PROBE BUT CHOOSE ALL THAT APPLY]

1. BUSINESS CLOSED	2. LAID OFF/LET GO	3. POOR HEALTH/DISABLED	4. FAMILY CARE	5. BETTER JOB
GO TO J080 BRANCHPOINT	GO TO J079			
6. QUIT	7. RETIRED	9. OWNERSHIP CHANGED	10. PENSION RULES CHANGED	
97. OTHER (SPECIFY) _____	98. DK	99. RF		
J074				

J075 BRANCHPOINT: IF R WAS SELF-EMPLOYED AT R's LAST IW (Z136=2), GO TO J080 BRANCHPOINT

J075

Did your employment situation change in some way that encouraged you to leave?

1. YES	5. NO	8. DK	9. RF
GO TO J078			

J076

How did it change?

[IWER: CHOOSE ALL THAT APPLY]

1. SUPERVISOR ENCOURAGED DEPARTURE	2. COWORKER ENCOURAGED DEPARTURE	3. WAGES REDUCED (OR ABOUT TO BE REDUCED)	4. HOURS REDUCED (OR ABOUT TO BE REDUCED)
			GO TO J079
5. WOULD HAVE BEEN LAID OFF	6. NEW JOB DUTIES	7. NEW JOB LOCATION	8. BECAME ELIGIBLE FOR PENSION
9. EMPLOYER CHANGED HEALTH INSURANCE		10. SPECIAL EARLY RETIREMENT INCENTIVE OFFER	
97. OTHER (SPECIFY) _____	98. DK	99. RF	
J077			

J078

{CORE WORDING} If your employer had allowed you to work fewer hours with correspondingly less pay, would you have continued working there?

1. YES	5. NO	8. DK	9. RF
--------	-------	-------	-------

J079

Did your employer experience a permanent reduction in employment between [CURRENT IW MONTH, YEAR 2 YEARS AGO/R's LAST IW MONTH, YEAR] and the time you were leaving?

[IWER: PERMANENT EMPLOYMENT REDUCTIONS ARE SOMETIMES CALLED "DOWNSIZING"; "LAYOFFS" CAN BE PERMANENT OR TEMPORARY.]

1. YES	5. NO	8. DK	9. RF
--------	-------	-------	-------

J080 BRANCHPOINT: IF R STOPPED WORKING FOR {LAST IW EMPLOYER or SELF} {ONE MONTH OR LESS} AFTER R's LAST IW (per {J063&J064 or J023&J024 or J017&J018}) or R DID NOT SAY WHEN S/HE STOPPED WORKING FOR {LAST IW EMPLOYER or SELF} ({J063 or J064}={DK or RF} or {{J023 or J024} or {J017 or J018}}={DK or RF}),  
GO TO J084 BRANCHPOINT

J080

Were there any months between *R's LAST IW MONTH, YEAR* and *MONTH, YEAR R STOPPED WORKING FOR [EMPLOYER (per J063&J064)/SELF (per J023&J024)]* when you did not work [at this business/for this employer]?

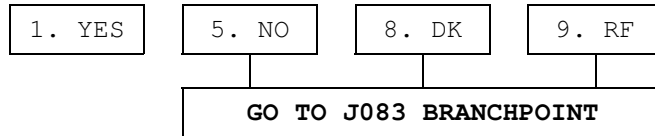

J081

Which months were those?

[IWER: MONTHS ENTERED MUST BE BETWEEN R's LAST IW MONTH, YEAR AND MONTH, YEAR R STOPPED WORKING FOR [EMPLOYER (per J063&J064)/SELF (per J023&J024)]]

[IWER: PRESS [F9] AND ARROW DOWNWARD FOR WHOLE YEAR AND OTHER CHOICES, THEN PRESS [ENTER] TO RETURN TO ANSWER BOX]

[IWER: CHOOSE ALL THAT APPLY]

MONTHS IN 2006	MONTHS IN 2007	MONTHS IN 2008	OTHER YEARS
(1) JAN 06	(14) JAN 07	(27) JAN 08	(41) ALL OF 2006 (AFTER PREV IW MO)
(2) FEB 06	(15) FEB 07	(28) FEB 08	(42) ALL OF 2005 (AFTER PREV IW MO)
(3) MAR 06	(16) MAR 07	(29) MAR 08	(43) ALL OF 2005
(4) APR 06	(17) APR 07	(30) APR 08	(44) ALL OF 2004 (AFTER PREV IW MO)
(5) MAY 06	(18) MAY 07	(31) MAY 08	(45) ALL OF 2004
(6) JUN 06	(19) JUN 07	(32) JUN 08	(46) ALL OF 2003 (AFTER PREV IW MO)
(7) JUL 06	(20) JUL 07	(33) JUL 08	(47) ALL OF 2003
(8) AUG 06	(21) AUG 07	(34) AUG 08	(48) ALL OF 2002 (AFTER PREV IW MO)
(9) SEP 06	(22) SEP 07	(35) SEP 08	(49) ALL OF 2002
(10) OCT 06	(23) OCT 07	(36) OCT 08	(50) ALL OF 2001 (AFTER PREV IW MO)
(11) NOV 06	(24) NOV 07	(37) NOV 08	(51) ALL OF 2001
(12) DEC 06	(25) DEC 07	(38) DEC 08	(52) ALL OF 2000 (AFTER PREV IW MO)
(13) ALL OF 2006	(26) ALL OF 2007	(39) ALL OF 2008 TO DATE	(53) ALL OF 2000
		(40) ALL OF 2008	(54) ALL OF 1999 (AFTER PREV IW MO)
			(55) ALL OF 1999
			(56) ALL OF 1998 (AFTER PREV IW MO)
			(57) ALL OF 1998
			(58) ALL OF 1997 (AFTER PREV IW MO)
			(59) ALL OF 1997
			(60) ALL OF 1996 (AFTER PREV IW MO)
			(61) ALL OF 1996
			(62) ALL OF 1995 (AFTER PREV IW MO)
			(63) ALL OF 1995
			(64) ALL OF 1994 (AFTER PREV IW MO)
			(65) ALL OF 1994
			(66) ALL OF 1993 (AFTER PREV IW MO)
			(67) ALL OF 1993
			(68) ALL OF 1992 (AFTER PREV IW MO)
			(69) OTHER (SPECIFY) [J082]
			(98) DK
			(99) RF

NOTE: THE ONLY CHOICES PRESENTED TO THE IWER ARE THOSE FOR MONTHS AND YEARS FROM R's LAST IW DATE UNTIL CURRENT IW MONTH & YEAR.

J083 BRANCHPOINT: IF R DID NOT REPORT THAT IS {RETIRED AND WORKING FOR SAME EMPLOYER/BUSINESS} (J058 NOT 3) *and* {NOT WORKING FOR SAME EMPLOYER- OWNERSHIP HAS CHANGED} (J045 NOT 4), GO TO J084 BRANCHPOINT

J083

Is your current work on this job being credited to the pension plan that you were a member of in your previous interview?

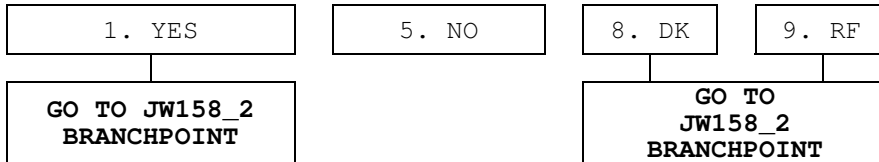

J084 BRANCHPOINT: IF R HAD PENSION PLAN ON JOB AT R's LAST IW (Z133=1), ASSIGN 1 TO J084 AND GO TO J085



J084

IF NOT SELF-EMPLOYED AT R's LAST IW (Z136 NOT 2):

Were you included in a pension or retirement plan, or in any tax deferred savings plan, through your work when you worked for [R's LAST IW EMPLOYER NAME (per Z091)/that employer]?

OTHERWISE:

Aside from IRAs not sponsored by your business or KEOGH plans, were you included in a pension or retirement plan, or in any tax deferred savings plan, through your work?

[IWER: IF R MENTIONS IRA OR SOCIAL SECURITY, NOTE IN COMMENT BOX AND SAY:]

I will ask about these later in the interview. Here, I just want to find out about other plans operated through your previous [business/employer].

IF NOT SELF-EMPLOYED AT R's LAST IW (Z136 NOT 2):

Was R's FIRST NAME included in a pension or retirement plan, or in any tax deferred savings plan, through [his/her] work when [he/she] worked for [R's LAST IW EMPLOYER NAME (per Z091)/that employer]?

OTHERWISE:

Aside from IRAs not sponsored by [his/her] business or KEOGH plans, was R's FIRST NAME included in a pension or retirement plan, or in any tax deferred savings plan, through [his/her] work?

[IWER: IF R MENTIONS IRA OR SOCIAL SECURITY, NOTE IN COMMENT BOX AND SAY:]

I will ask about these later in the interview. Here, I just want to find out about other plans operated through [his/her] previous [business/employer].

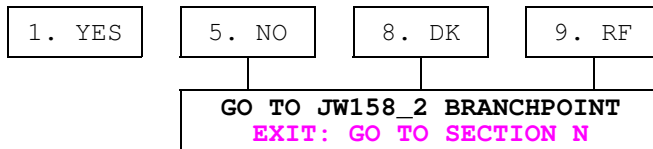

J085

IF R REPORTED AT LAST IW THAT WAS INCLUDED IN PENSION PLAN ON THIS JOB (Z133=1):

According to our records, you reported that you were included in one or more pension plans on this job.

In how many different pension plans were you included on this job?

[IWER: ENTER "95" IF R DENIES BEING INCLUDED IN ANY PENSION PLAN]

OTHERWISE:

In how many different pension plans were you included on this job?

IF R REPORTED AT LAST IW THAT R WAS INCLUDED IN PENSION PLAN ON THIS JOB (Z133=1):

According to our records, R's FIRST NAME reported that [he/she] was included in one or more pension plans on this job.

In how many different pension plans was [he/she] included on this job?

[IWER: ENTER "95" IF R DENIES BEING INCLUDED IN ANY PENSION PLAN]

OTHERWISE:

In how many different pension plans was [he/she] included on this job?

1 - 8 PLANS

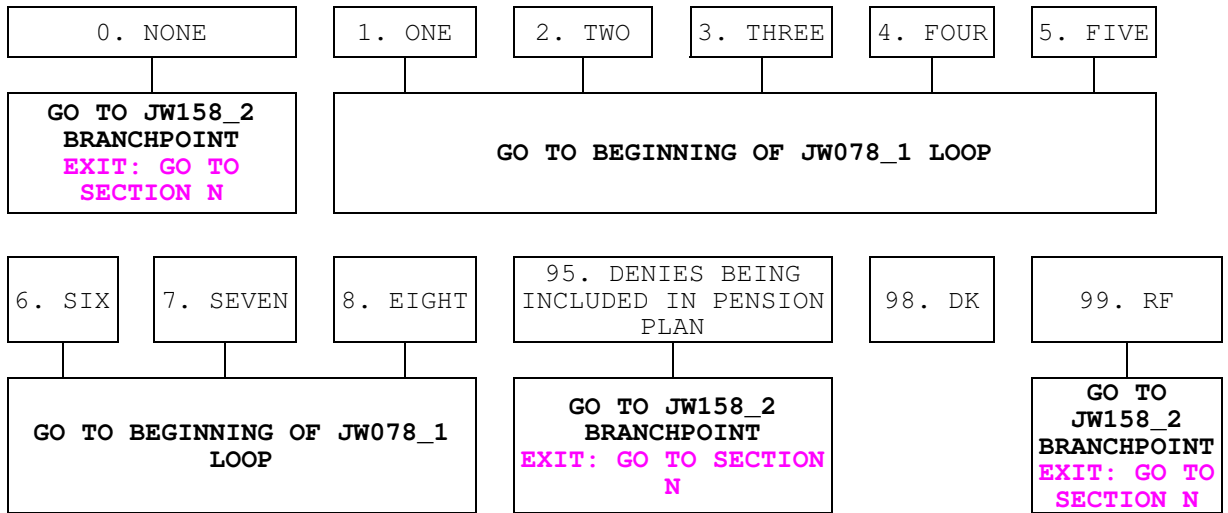

J086

Is this just one plan or more than one?

Was this just one plan or more than one?

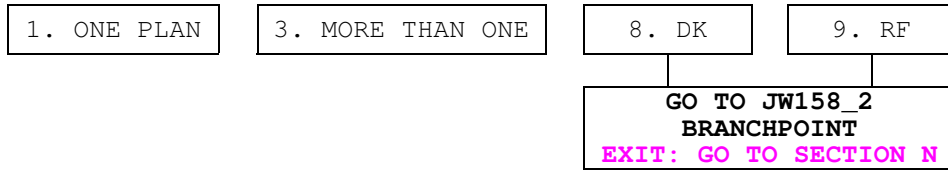

NOTE: THE FOLLOWING SERIES OF PENSION QUESTIONS COMPRISES THE PENSION BLOCK. (JW078\_1 - JW077\_1) IS REPLICATED IN SECTION K AND TWICE IN SECTION L AND IS KNOWN AS THE SECTION J PENSION BLOCK.

BEGINNING OF PENSION BLOCK-1:

(JW078\_1 — JW077\_1)

QUESTION NUMBERS WITHIN THE PENSION BLOCK ARE JW078\_1 - JW077, PRECEDED BY THE SECTION NAME, J, AND FOLLOWED BY "\_1" WHICH INDICATES THAT THIS IS THE FIRST TIME THE EMPLOYER NAME BLOCK HAS OCCURRED WITHIN THE QUESTIONNAIRE.

\*\*\*BEGINNING OF JW078\_1 LOOP: QUESTIONS JW078\_1 THROUGH JW077\_1 ARE REPEATED FOR UP TO FOUR PENSION PLANS IF R [PROXY] REPORTED THE NUMBER OF PLANS AT J085 (J085={1-8}) OR FOR UP TO TWO PLANS IF R [PROXY] REPORTED HAVING PLANS AT J086 (J086={1 or 3}).\*\*\*

JW078\_1

IF THIS IS THE FIRST PLAN AND R HAD MORE THAN ONE PLAN (J085 ≥2 or J086=3):

Now I have some questions about the most important of these plans.

What was the name of this plan?

IF THIS IS THE SECOND, THIRD OR FOURTH PLAN (J085 ≥2) or R HAD MORE THAN ONE PLAN (J086=3):

Now I have some questions about the next most important of these plans.

What was the name of this plan?

IF R HAD ONLY ONE PLAN ({J085 or J086}=1):

What was the name of this plan?

IF THIS IS THE FIRST PLAN AND R HAD MORE THAN ONE PLAN (J085 ≥2 or J086=3):

Now I have some questions about the most important of these plans.

What was the name of this plan?

IF THIS IS THE SECOND, THIRD OR FOURTH PLAN (J085 ≥2) or R HAD MORE THAN ONE PLAN (J086=3):

Now I have some questions about the next most important of these plans.

What was the name of this plan?

IF R HAD ONLY ONE PLAN ({J085 or J086}=1):

What was the name of this plan?

\_\_\_\_\_

DK

RF

NAME OF PLAN

JW082\_1

Was it a 401K, a Supplemental Retirement Account (SRA), defined benefit, defined contribution, or what?

(What did your former employer call it?)

Was it a 401K, a Supplemental Retirement Account (SRA), defined benefit, defined contribution, or what?

(What did [his/her] former employer call it?)

1. 401K PLAN	2. SUPPLEMENTAL RETIREMENT ACCOUNT (SRA)	3. DEFINED BENEFIT PLAN	4. DEFINED CONTRIBUTION PLAN	5. 401A
6. 403B PLAN	7. 457 PLAN	8. THRIFT/SAVINGS PLAN (TSP)	9. PROFIT- SHARING PLAN	10. EMPLOYEE STOCK OWNERSHIP PLAN (ESOP)
11. MONEY PURCHASE PLAN	12. PORTABLE CASH OPTION PLAN	13. EMPLOYEE STOCK PURCHASE PLAN (ESPP)	14. SEP OR SIMPLE PLAN	
15. COMBINATION PLAN	16. CASH BALANCE PLAN	97. OTHER (SPECIFY)  JW083_1	98. DK	99. RF

JW001\_1

{CORE AND EXIT}

(Could you tell me a little more about this plan?)

I would like to know what type of plan this was.

READ TO ALL CORE Rs ON THE FIRST LOOP; READ ON SUBSEQUENT LOOPS IF NECESSARY:

In some retirement plans, call them Type A, benefits are usually based on a formula involving age, years of service and salary. In other plans, call them Type B, money is accumulated in an account for you.

ALL EXIT Rs:

In some retirement plans, call them Type A, benefits are usually based on a formula involving age, years of service and salary. In other plans, call them Type B, money is accumulated in an account for [him/her].

NOTE: IF R HAS ALREADY BEEN THROUGH THE LOOP ONCE, THE EXPLANATION, ABOVE, APPEARS IN PARENTHESES AND IS READ AT THE IWER'S DISCRETION.

{CORE WORDING} Was your plan Type A or Type B?

{EXIT WORDING} Was [his/her] plan Type A or Type B?

[IWER: IF R HAS MULTIPLE PLANS OF DIFFERENT TYPES, RECORD THEM AS SEPARATE PLANS RATHER THAN COMBINING THEM AS 'BOTH'.]

DEFINITION: 401-K, 403-B, 457, ESOP, SRA, THRIFT/SAVINGS (TSP), STOCK/PROFIT SHARING, MONEY PURCHASE PLANS, SEP/SIMPLE, 401A, AND CASH BALANCE PLANS ARE ALL TYPE B RETIREMENT PLANS. TYPE A PLANS ARE OFTEN CALLED 'DEFINED BENEFIT' PLANS. TYPE B PLANS ARE OFTEN CALLED 'DEFINED CONTRIBUTION'.

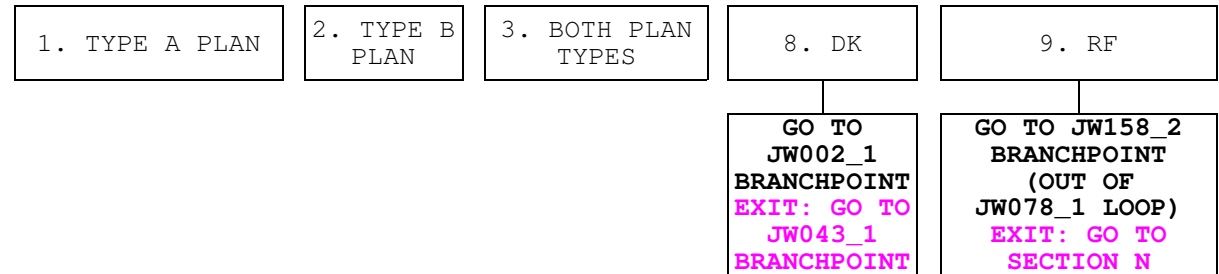

JW085\_1

Sometimes people are not sure about the type of retirement plans they have. We are interested in how certain you are about the type of plans you had on that job.

Are you very certain, somewhat certain or not certain at all that you actually had (a) [TYPE OF PLAN per JW001\_1]?

Sometimes people are not sure about the type of retirement plans they have. We are interested in how certain you are about the type of plans R's FIRST NAME had on that job.

Are you very certain, somewhat certain or not certain at all that [he/she] actually had (a) [TYPE OF PLAN per JW001\_1]?

- |                 |                     |                       |       |       |
|-----------------|---------------------|-----------------------|-------|-------|
| 1. VERY CERTAIN | 2. SOMEWHAT CERTAIN | 3. NOT CERTAIN AT ALL | 8. DK | 9. RF |
|-----------------|---------------------|-----------------------|-------|-------|

JW034\_1

How many years altogether were you included in this plan?

How many years altogether was [he/she] included in this plan?

[IWER: INCLUDE YEARS WITH OTHER EMPLOYERS IF SAME PLAN]

[IWER: ROUND THE VALUE TO THE NEAREST YEAR]

- \_\_\_\_\_
- |    |    |
|----|----|
| DK | RF |
|----|----|
- 0-50 YEARS

JW043\_1 BRANCHPOINT: IF THIS IS NOT AN EXIT INTERVIEW, GO TO JW002\_1 BRANCHPOINT

IF THIS IS AN EXIT INTERVIEW and R WAS NOT COUPLED AT THE TIME OF DEATH (X065 {NOT 1 and NOT 3}), GO TO END OF JW078\_1 LOOP (AFTER JW077\_1)

JW043\_1

Did [you/R's FIRST NAME's [husband/wife/partner]] or will [you/[his/her] [husband/wife/partner]] receive any benefits from this plan?

- |        |       |       |       |
|--------|-------|-------|-------|
| 1. YES | 5. NO | 8. DK | 9. RF |
|--------|-------|-------|-------|
- GO TO END OF JW078\_1 LOOP (AFTER JW077\_1)

JW002\_1 BRANCHPOINT: IF R/**BENEFICIARY** CONSISTENTLY REPORTED TYPE A/DEFINED BENEFIT PLAN ({JW082\_1=3 and JW001\_1}=1), GO TO JW097\_1

JW002\_1

{CORE} IF TYPE B PLAN:

How much money was in your account when you left that [business/employer]?

OTHERWISE:

For the part of your pension where money is accumulated in an account, how much money was in your account when you left that [business/employer]?

{EXIT} IF TYPE B PLAN:

How much money was in [his/her] account when [he/she] died?

OTHERWISE:

For the part of [his/her] pension where money was accumulated in an account, how much money was in [his/her] account when [he/she] died?

[IWER: IF R SAYS 'DOES NOT HAVE AN ACCOUNT', ENTER [-2]]

[IWER: DO NOT PROBE DK/RF]

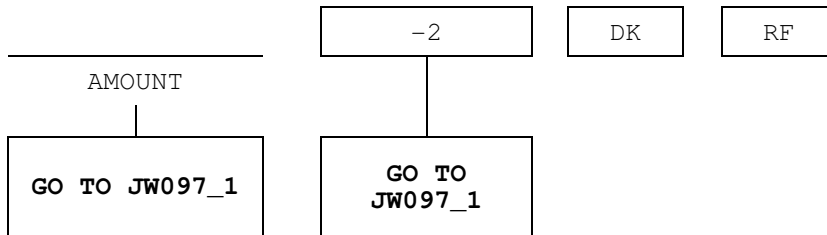

JW003\_1 - JW005\_1 Unfolding Sequence

Question text: {CORE **AND EXIT**} Did it amount to a total of less than \$\_\_\_\_ , more than \$\_\_\_\_ , or what?

PROCEDURES: 2Up1Down, 1Up2Down

BREAKPOINTS: \$5,000, **\$20,000**, **\$50,000**, \$150,000

RANDOM ENTRY POINTS: \$20,000, \$50,000

ENTRY POINT ASSIGNMENT: 1 OR {NOT 1} AT X503

ORDER OF ENTRY POINT ASSIGNMENTS AND PROCEDURES CORRESPOND



JW097\_1

IF R IS {RETIRED AND WORKING FOR SAME EMPLOYER/BUSINESS} (J058=3):  
When you retired, what did you do with that plan?

(Are you receiving benefits in the form of regular payments now, did you withdraw all or part of the money, roll it over into an IRA, leave it in the old plan, did you convert it to or purchase an annuity, did you transfer it to a new employer, did you lose your benefits, did you receive or are you receiving one or more installments or irregular payments, or what?)

OTHERWISE:

When you left that [business/employer], what did you do with that plan?

(Are you receiving benefits in the form of regular payments now, did you withdraw all or part of the money, roll it over into an IRA, leave it in the old plan, did you convert it to or purchase an annuity, did you transfer it to a new employer, did you lose your benefits, did you receive or are you receiving one or more installments or irregular payments, or what?)

[IWER: DO NOT PROBE, BUT CHOOSE ALL THAT APPLY AND ASK ALL APPROPRIATE FOLLOW-UP QUESTIONS]

We are interested in what [you/R's FIRST NAME's [husband/wife/partner]] did with that plan. When [he/she] died, what did [you/R's FIRST NAME's [husband/wife/partner]] do with that plan?

(Are/Is [you/R's FIRST NAME's [husband/wife/partner]] receiving benefits in the form of regular payments now, did [you/R's FIRST NAME's [husband/wife/partner]] withdraw all or part of the money, roll it over into an IRA, leave the plan unchanged, convert it to or purchase an annuity, continue collecting all or part of the benefits, lose the benefits, did [you/R's FIRST NAME's [husband/wife/partner]] receive or [are you/is R's FIRST NAME's [husband/wife/partner]] receiving one or more installments or irregular payments, or what?)

[IWER: DO NOT PROBE, BUT CHOOSE ALL THAT APPLY AND ASK ALL APPROPRIATE FOLLOW-UP QUESTIONS]

8. RECEIVING BENEFITS NOW	1. WITHDREW THE MONEY/RECEIVED CASH SETTLEMENT/LUMP-SUM	2. ROLLED OVER INTO IRA	3. LEFT IN THE PLAN
4. CONVERT TO/PURCHASED ANNUITY	5. TRANSFERRED TO NEW EMPLOYER EXIT: 9. CONTINUED COLLECTING ALL/PART OF R'S BENEFITS	6. LOST BENEFITS	
7. RECEIVED/RECEIVING INSTALLMENTS/TOOK IRREGULAR WITHDRAWALS	97. OTHER (SPECIFY) _____ JW007_1	98. DK	99. RF

NOTE: A RESPONSE CODE OF "6. LOST BENEFITS" MAY NOT BE SELECTED WITH ANY OTHER RESPONSE.

JW088\_1 BRANCHPOINT: IF R/BENEFICIARY DID NOT LEAVE MONEY IN THE PLAN (JW097\_1 NOT 3), GO TO JW065\_1 BRANCHPOINT

JW088\_1

IF MORE THAN ONE OPTION WAS SELECTED IN JW097\_1:  
For the part of the money that you left in the plan,

ALL Rs:

[Do/do] you expect to receive benefits from this plan in the form of regular monthly or annual payments at some time in the future?

IF MORE THAN ONE OPTION WAS SELECTED IN JW097\_1:  
For the part of the money that was left in the plan,

ASK OF ALL Rs:

[Do/do/[Does/does]] [you/R's FIRST NAME's [husband/wife/partner] expect to receive benefits from this plan in the form of regular monthly or annual payments at some time in the future?

1. YES

5. NO

8. DK

9. RF

JW065 BRANCHPOINT: IF R/BENEFICIARY {WITHDREW THE MONEY/RECEIVED CASH SETTLEMENT/LUMP-SUM or LOST BENEFITS} ({JW097\_1}={1 or 6}), GO TO JW008\_1 BRANCHPOINT

JW065

Were you allowed to receive benefits as a cash settlement or a lump-sum payment?

[Were/Was] [you/R's FIRST NAME's [husband/wife/partner]]allowed to receive benefits as a cash settlement or a lump-sum payment?

1. YES

5. NO

8. DK

9. RF

JW008\_1 BRANCHPOINT: IF R/BENEFICIARY DID NOT REPORT THAT MONEY WAS (LEFT IN THE PLAN/LEFT UNCHANGED) {JW097\_1 NOT 3), GO TO JW063\_1/BRANCHPOINT

JW008\_1

How much money did you leave in the old plan?

How much money did [you/he/she] leave in that plan?

\_\_\_\_\_

AMOUNT

DK	RF
----	----

JW063\_1 BRANCHPOINT: IF R/BENEFICIARY {DID NOT RECEIVE OR IS NOT RECEIVING} {ONE OR MORE} {INSTALLMENTS OR IRREGULAR PAYMENTS} (JW097\_1 NOT 7), GO TO JW009\_1 BRANCHPOINT

JW063\_1

How much money in total did you receive in installments or irregular payments in the last calendar year?

How much money in total did [you/he/she] receive in installments or irregular payments in the last calendar year?

\_\_\_\_\_

AMOUNT

DK	RF
----	----

JW009\_1 BRANCHPOINT: IF R/BENEFICIARY CONSISTENTLY REPORTED TYPE A/DEFINED BENEFIT PLAN (JW082\_1=3 and JW001\_1=1), GO TO JW013\_1 BRANCHPOINT

IF R/BENEFICIARY DID NOT REPORT THAT MONEY WAS LEFT IN THE PLAN/LEFT UNCHANGED} (JW097\_1 NOT 3) or R REPORTED DOES NOT HAVE ACCOUNT (JW002\_1=-2), GO TO JW013\_1 BRANCHPOINT

JW009\_1

How much is in that account now?

How much is in that account now?

[IWER: DO NOT PROBE DK/RF]

\_\_\_\_\_

DK	RF
----	----

AMOUNT

GO TO  
JW013\_1 BRANCHPOINT

JW010\_1 - JW012\_1 Unfolding Sequence

Question text: {CORE AND EXIT} Did it amount to less than \$\_\_\_\_ , more than \$\_\_\_\_ , or what?

PROCEDURES: 2Up1Down, 1Up2Down

BREAKPOINTS: \$10,000, \$20,000, \$50,000, \$150,000

RANDOM ENTRY POINTS: \$20,000, \$50,000

ENTRY POINT ASSIGNMENT: 1 OR {NOT 1} AT X504

ORDER OF ENTRY POINT ASSIGNMENTS AND PROCEDURES CORRESPOND

JW013\_1 BRANCHPOINT: IF R/BENEFICIARY DID NOT REPORT RECEIVING BENEFITS NOW (JW097\_1 NOT 8) and DID NOT REPORT THAT MONEY IN PENSION PLAN WAS CONVERTED TO/PURCHASED AN ANNUITY (JW097\_1 NOT 4) and DID NOT REPORT CONTINUED COLLECTING ALL/PART OF R'S BENEFITS (JW097\_1 NOT 9), GO TO JW018\_1 BRANCHPOINT

IF R/BENEFICIARY REPORTED RECEIVING BENEFITS NOW or CONTINUED COLLECTING ALL/PART OF R'S BENEFITS (JW097\_1=8 or 9) and DID NOT REPORT THAT MONEY IN PENSION PLAN WAS CONVERTED TO/PURCHASED AN ANNUITY (JW097\_1 NOT 4), GO TO JW014\_1

JW013\_1

How much did you (convert to/purchase as) an annuity?

How much did [you/he/she] (convert to/purchase as) an annuity?

\_\_\_\_\_

DK	RF
----	----

AMOUNT

JW014\_1

How old were you when you started receiving benefits?

How old [were you/was R's FIRST NAME's [husband/wife/partner]] when [you/he/she] started receiving benefits?

[IWER: IF R MENTIONS AGE AND SOME NUMBER OF MONTHS, E.G., 59 AND ½, ENTER AGE HERE AND GO TO THE NEXT SCREEN TO ENTER MONTHS]

50-80 AGE

\_\_\_\_\_

AGE

DK	RF
GO TO JW015_1	

JW086\_1

[IWER: IF R REPORTS AGE AND MONTHS, ENTER NUMBER OF MONTHS]

[IWER: IF R DID NOT MENTION MONTHS, PRESS [ENTER] TO CONTINUE]

\_\_\_\_\_  
1-12 NUMBER OF  
MONTHS

JW015\_1

How much are the benefits per month or year?

How much are the benefits per month or year?

[IWER: IF BENEFITS HAVE NOT YET STARTED, RECORD WHAT BENEFITS WILL BE]

\_\_\_\_\_

AMOUNT

0	DK	RF
GO TO JW049_1 (AFTER JW017_1)		

JW016\_1

[IWER: PROBE IF NECESSARY]

Is that per month or year?

Is that per month or year?

PER:

4. MONTH	6. YEAR	7. OTHER (SPECIFY) _____ JW017_1	8. DK	9. RF
----------	---------	--	-------	-------

JW028\_1

Are the benefits adjusted for changes in the cost of living?  
 Are the benefits adjusted for changes in the cost of living?

1. YES	5. NO	8. DK	9. RF
--------	-------	-------	-------

GO TO JW049\_1

JW059\_1

Are the benefits adjusted automatically?  
 Are the benefits adjusted automatically?

1. YES	5. NO	8. DK	9. RF
--------	-------	-------	-------

JW049\_1

IF R IS MARRIED/PARTNERED (X065={1 or 3}):  
 Will this payment continue only as long as you live, as long as either you or your [husband/wife/partner] live, is it for a fixed time period, or what?

OTHERWISE:  
 Will this payment continue as long as you live, is it for a fixed time period, or what?

Will this payment continue as long as [you/R's FIRST NAME's [husband/wife/partner]] [live/lives], is it for a fixed time period, or what?

1. AS LONG AS R LIVES EXIT: DID NOT DISPLAY	2. AS LONG AS R OR SPOUSE/PARTNER LIVES EXIT: AS LONG AS SPOUSE/PARTNER LIVES	3. FOR A FIXED TIME PERIOD
--	--	----------------------------

GO TO JW054\_1 BRANCHPOINT

7. OTHER (SPECIFY) _____ JW050_1	8. DK	9. RF
--	-------	-------

GO TO JW054\_1 BRANCHPOINT

NOTE: CODE 2 IS NOT SEEN FOR NON-COUPLED Rs.

JW051\_1

What is that time period?  
What is that time period?

\_\_\_\_\_ OR \_\_\_\_\_ OR \_\_\_\_\_  DK  RF  
JW051\_1 UNTIL YEAR JW052\_1 UNTIL AGE JW053\_1 YEARS

JW054\_1 BRANCHPOINT: IF THIS IS AN EXIT INTERVIEW or R IS NOT MARRIED/PARTNERED (X065 {NOT 1 and NOT 3}), GO TO JW018\_1 BRANCHPOINT

JW054\_1

If you or your [husband/wife/partner] should die, will the pension payments change, stay the same, or what?

5. CHANGE  3. STAY THE SAME  7. OTHER (SPECIFY)  8. DK  9. RF  
\_\_\_\_\_ JW055\_1

JW018\_1 BRANCHPOINT: IF R DID NOT REPORT THAT MONEY IN PENSION ACCOUNT WAS ROLLED OVER INTO AN IRA (JW097\_1 NOT 2), GO TO JW019\_1 BRANCHPOINT

JW018\_1

How much did the rollover amount to?  
How much did the rollover amount to?

\_\_\_\_\_  DK  RF  
AMOUNT

JW019\_1 BRANCHPOINT: IF THIS IS AN EXIT INTERVIEW, GO TO JW056\_1 BRANCHPOINT  
IF R DID NOT REPORT THAT MONEY IN PENSION ACCOUNT WAS TRANSFERRED TO NEW EMPLOYER (JW097\_1 NOT 5), GO TO JW056\_1 BRANCHPOINT

JW019\_1

How much did the transfer amount to?

\_\_\_\_\_  DK  RF  
AMOUNT

JW056\_1 BRANCHPOINT: IF R/BENEFICIARY DID NOT REPORT THAT WITHDREW THE MONEY/RECEIVED CASH SETTLEMENT/LUMP-SUM (JW097\_1 NOT 1), GO TO JW035\_1 BRANCHPOINT

JW056\_1

How much money did you withdraw or how much was the lump sum or cash settlement you received?

How much money did [you/[his/her] [husband/wife/partner]] withdraw or how much was the lump sum or cash settlement [you/[his/her] [husband/wife/partner]] received?

\_\_\_\_\_

AMOUNT

JW057\_1

What did you do with the money?

What did [you/he/she] do with the money?

1. BOUGHT DURABLES	2. SPENT IT	3. SAVED/INVESTED	4. PAID OFF DEBT
5. ROLLED INTO IRA	7. OTHER (SPECIFY) _____ JW058_1	8. DK	9. RF

JW035\_1 BRANCHPOINT: IF R DID NOT REPORT THAT EXPECTS FUTURE BENEFITS FROM PENSION (JW088\_1 NOT 1), GO TO JW042\_1 BRANCHPOINT

IF THIS IS {NOT A SELF INTERVIEW (A009={2 or 3}) and NOT AN EXIT INTERVIEW}, GO TO JW042\_1 BRANCHPOINT

IF R REPORTED RECEIVING BENEFITS NOW or CONTINUED COLLECTING ALL/PART OF R'S BENEFITS or CONVERTED/PURCHASED ANNUITY (JW097\_1=8 or 9 or 4), GO TO JW096\_1 BRANCHPOINT



JW035\_1

At what age do you expect to start receiving (the rest of your) benefits from this plan?

At what age [do you/does R's FIRST NAME's [husband/wife/partner]] expect to start receiving (the rest of [his/her]) benefits from this plan?

[IWER: IF R MENTIONS AGE AND SOME NUMBER OF MONTHS, E.G., 59 AND ½, ENTER AGE HERE AND GO TO THE NEXT SCREEN TO ENTER MONTHS]

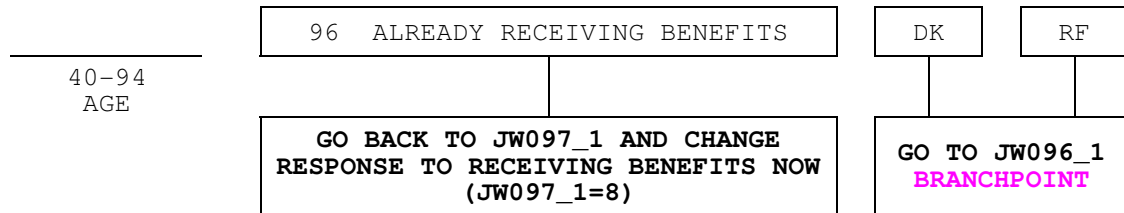

JW098\_1

[IWER: IF R REPORTS AGE AND MONTHS, ENTER NUMBER OF MONTHS]

[IWER: IF R DID NOT MENTION MONTHS, PRESS [ENTER] TO CONTINUE]

1-12 NUMBER OF MONTHS

JW036\_1

About how much do you expect these benefits to be, either as a percent of your pay when you left that job, or as an amount per month or year when you start receiving them?

About how much [do you/does [he/she]] expect these benefits to be, either as an amount per month or year or a lump sum amount?

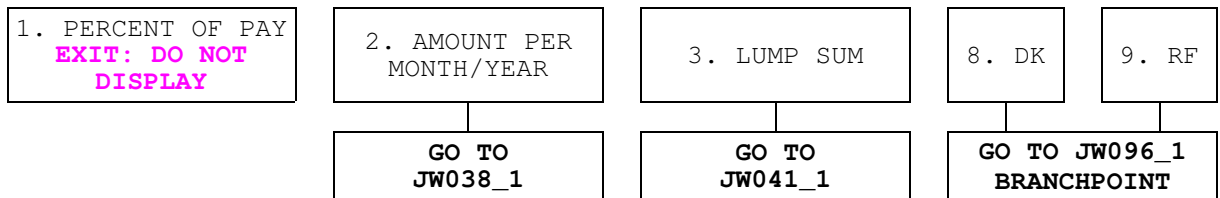

JW037\_1

{CORE ONLY} [IWER: ENTER PERCENT OF FINAL PAY]

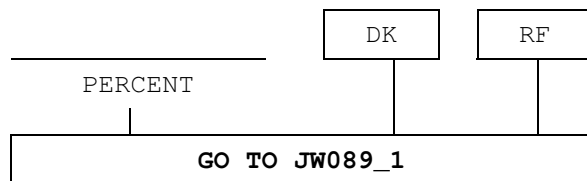

NOTE: EXIT R's ARE NEVER ASKED THIS QUESTION.

JW038\_1

[IWER: PROBE IF NECESSARY]

How much do you expect to receive?

How much [do you/does [he/she]] expect to receive?

[IWER: DO NOT PROBE DK/RF]

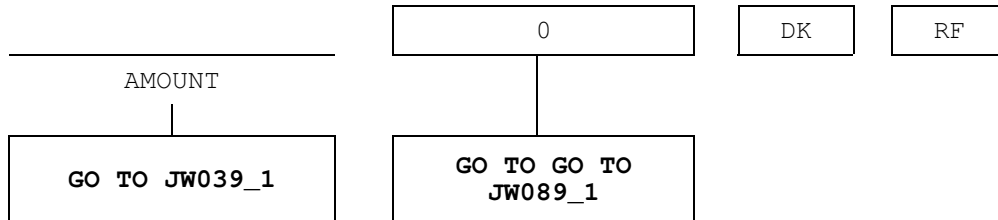

J133\_1 - J135\_1 Unfolding Sequence

Question text: Do you expect a total of less than \$\_\_\_\_ per month, more than \$\_\_\_\_ per month, or what?

PROCEDURES: 2Up1Down, 1Up2Down

BREAKPOINTS: \$500, \$1,000, \$2,000, \$3,000

RANDOM ENTRY POINTS: \$1,000, \$2,000

ENTRY POINT ASSIGNMENT: 1 OR {NOT 1} AT X507

ORDER OF ENTRY POINT ASSIGNMENTS AND PROCEDURES CORRESPOND

JW039\_1 BRANCHPOINT: GO TO JW089\_1

JW039\_1

[IWER: PROBE IF NECESSARY]

Is that per month or year?

Is that per month or year?

PER:

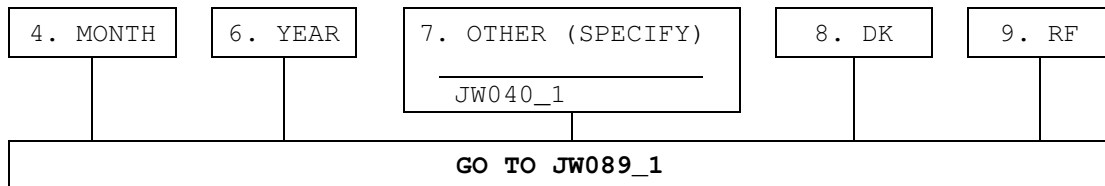

JW041\_1

{CORE AND EXIT} [IWER: ENTER LUMP SUM AMOUNT]

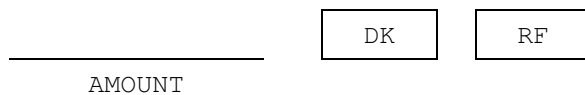

JW089\_1 BRANCHPOINT: GO TO JW042\_1 BRANCHPOINT

JW089\_1

IF R IS MARRIED/PARTNERED (X065={1 or 3}):

Will this payment continue only as long as you live, as long as either you or your [husband/wife/partner] live, is it for a fixed time period, or what?

OTHERWISE:

Will this payment continue as long as you live, is it for a fixed time period, or what?

Will this payment continue as long as [you/R's FIRST NAME's [husband/wife/partner]] [live/lives], is it for a fixed time period, or what?

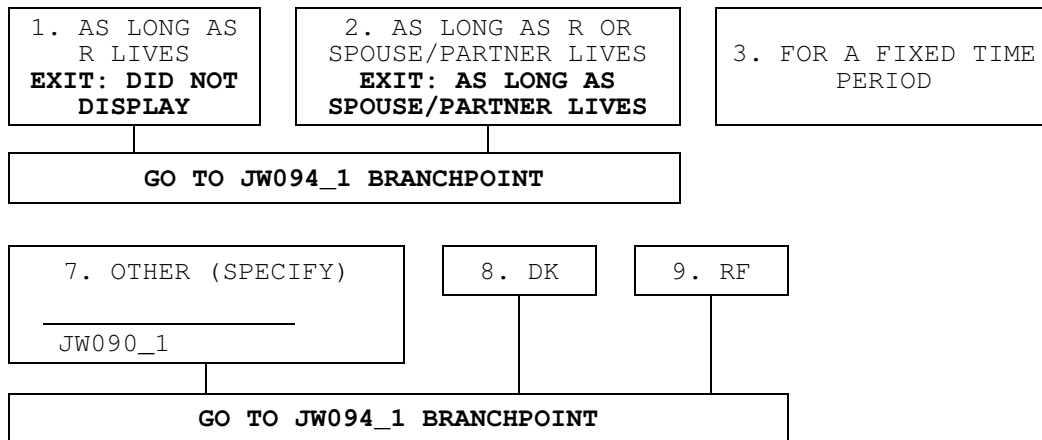

NOTE: CODE 2 IS NOT SEEN FOR NON-COUPLED Rs.

JW091\_1

What is that time period?

What is that time period?

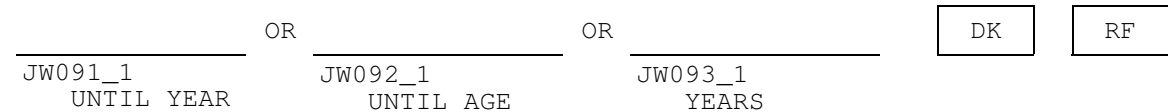

JW094\_1 BRANCHPOINT: IF THIS IS AN EXIT INTERVIEW or R IS NOT MARRIED/PARTNERED (X065 {NOT 1 and NOT 3}), GO TO JW096\_1 BRANCHPOINT

JW094\_1

If you or your [husband/wife/partner] should die, will the pension payment change, stay the same, or what?

1. CHANGE

3. STAY THE SAME

7. OTHER (SPECIFY)

8. DK

9. RF

JW095\_1

JW096\_1 BRANCHPOINT: IF R/**BENEFICIARY** REPORTED {EXPECTS FUTURE BENEFITS FROM PENSION or CURRENTLY RECEIVING BENEFITS} and LEFT MONEY IN THE PLAN ({JW088\_1=1 or {JW097\_1=8} and JW097\_1=3), CONTINUE ON TO JW096

OTHERWISE, GO TO JW042\_1 **BRANCHPOINT**

JW096\_1

IF R EXPECTS TO RECEIVE FUTURE BENEFITS (JW088\_1=1):

You mentioned that you left money in this plan and you expect future benefits from this plan. Is the money you reported leaving in the plan the same as the money that will finance your future benefits?

IF R IS CURRENTLY RECEIVING BENEFITS (JW097\_1=8):

You mentioned that you left money in this plan and you are currently receiving benefits from this plan. Is the money you reported leaving in the plan the same as the money financing the benefits you are drawing from?

IF **BENEFICIARY** EXPECTS TO RECEIVE FUTURE BENEFITS (JW088\_1=1):

You mentioned that [you/R's **FIRST NAME's** [husband/wife/partner]] left money in this plan and [you/R's **FIRST NAME's** [husband/wife/partner]] expect(s) future benefits from this plan. Is the money [you/R's **FIRST NAME's** [husband/wife/partner]] reported leaving in the plan the same as the money that will finance [your/R's **FIRST NAME's** [husband's/wife's/partner's]] future benefits?

IF **BENEFICIARY** IS CURRENTLY RECEIVING BENEFITS (JW097\_1=8):

You mentioned that [you/R's **FIRST NAME's** [husband/wife/partner]] left money in this plan and [you/R's **FIRST NAME's** [husband/wife/partner]] [are/is] currently receiving benefits from this plan. Is the money [you/R's **FIRST NAME's** [husband/wife/partner]] reported leaving in the plan the same as the money financing the benefits [you/R's **FIRST NAME's** [husband/wife/partner]] [are/is] drawing from?

1. NO, DIFFERENT MONEY

2. YES, THE SAME MONEY

3. YES, PARTLY THE SAME

8. DK

9. RF

JW042\_1 BRANCHPOINT: IF THIS IS AN EXIT INTERVIEW, GO TO END OF JW078\_1 LOOP  
(AFTER JW077\_1)

JW042\_1

What is the earliest age at which you could have left that job and begun to receive pension benefits from this plan?

[IWER: IF R MENTIONS AGE AND SOME NUMBER OF MONTHS, E.G., 59 AND ½, ENTER AGE HERE AND GO TO THE NEXT SCREEN TO ENTER MONTHS]

30-80 AGE

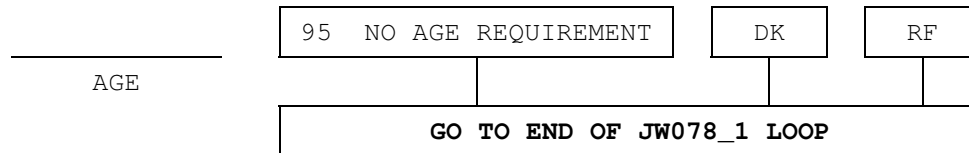

JW077\_1

[IWER: IF R REPORTS AGE AND MONTHS, ENTER NUMBER OF MONTHS]

[IWER: IF R DID NOT MENTION MONTHS, PRESS [ENTER] TO CONTINUE]

1-12 NUMBER OF  
MONTHS

\*\*\*END OF JW078\_1 LOOP: IF THERE ARE MORE PENSION PLANS GIVEN, REPEAT QUESTIONS JW078\_1 THROUGH JW077\_1) FOR UP TO FOUR PENSION PLANS IF [PROXY] REPORTED HAVING MORE THAN ONE PLAN AT J085 (J085={2-8}) OR FOR TWO PLANS IF [PROXY] REPORTED HAVING MORE THAN ONE PLAN AT J086 (J086=3). IF NOT, CONTINUE ON TO JW158\_2 BRANCHPOINT IF THIS IS A CORE IW; IF EXIT IW, GO TO SECTION N.\*\*\*

END OF PENSION BLOCK-1:  
(JW078\_1 — JW077\_1)

EXIT: GO TO SECTION N