NOTE ABOUT BRANCHPOINTS:

WHERE THERE IS MORE THAN ONE JUMP WITHIN A BRANCHPOINT BOX, THE JUMPS ARE TO BE APPLIED IN ORDER FROM THE TOP.

NOTE ABOUT COLORS:

ALL QUESTION TEXT IN BLACK IS FOR THE CORE INTERVIEW.

ALL QUESTION TEXT IN FUCHSIA IS FOR THE EXIT INTERVIEW. ALSO IN FUCHSIA IS ALL OTHER TEXT THAT IS SPECIFIC TO THE EXIT INTERVIEW BUT NOT TO THE CORE.

OTHERWISE, BLACK TEXT FOR CODEFRAMES, INTERVIEWER INSTRUCTIONS, JUMPS AND BRANCHPOINTS, ETC. CAN APPLY TO BOTH THE CORE AND THE EXIT INTERVIEW UNLESS SPECIFIED OTHERWISE OR THERE IS AN EXIT ALTERNATIVE.

ON A BLACK-AND-WHITE HARD COPY OF THE DOCUMENT, THE FUCHSIA TEXT WILL APPEAR SOMEWHAT LIGHTER THAN THE ORIGINAL BLACK.

NOTE ABOUT EXIT INTERVIEW Rs:

ANY NEW SPOUSE/PARTNER THAT AN EXIT INTERVIEW R ACQUIRED SINCE HIS/HER LAST INTERVIEW IS IGNORED FOR THE PURPOSES OF THIS INTERVIEW.

MAJOR FLOW CONTROL, CONDITION AND FILL VARIABLES *

THIS IS A NEW EXIT R (HAS NEVER BEFORE BEEN INTERVIEWED AS AN EXIT R: = {R DIED SINCE LAST IW or {R WAS REPORTED DEAD AT A PREVIOUS IW BUT EXIT IW HAS NEVER BEEN DONE FOR THIS R = NOT A POST-EXIT IW}}) (A007=5 and {Z145 {NOT 1 and NOT 2 and NOT 3 and NOT 4}})

THIS IS A **NEW POST-EXIT INTERVIEW** (Z145=2);
THIS IS A **FIRST REPEAT POST-EXIT INTERVIEW** (Z145=3);
THIS IS A **SECOND REPEAT POST-EXIT INTERVIEW** (Z145=4)

THIS IS A **SELF INTERVIEW** (A009=1);
THIS IS A **PROXY INTERVIEW** (A009={2 or 3}) or (A009 NOT 1);
PROXY REPORTER IS SURVIVING SPOUSE (A009=2);
PROXY REPORTER IS NON-SPOUSE (A009=3)

R IS **MARRIED** (X065=1);
R IS **PARTNERED** (X065=3);
R IS **OTHER (SINGLE)** (X065=6)

R WAS **MARRIED AT HH's LAST IW** (X066=1);
R WAS **NOT COUPLED AT HH's LAST IW** (X066 {NOT 1 and NOT 3});
R WAS **PARTNERED AT HH's LAST IW** (X066=3);
R WAS **SINGLE AT HH's LAST IW** (X066=6)

R WAS **MARRIED WHEN S/HE DIED** (A026=1)

R's **LAST IW SPOUSE/PARTNER WAS LIVING WHEN S/HE DIED** (A023=1);
R's **LAST IW SPOUSE/PARTNER WAS NOT LIVING WHEN S/HE DIED** (A023=5)

R's **FIRST NAME** (per X058)

HH's **LAST IW MAIN RESIDENCE CITY** (per X025), **STATE** (STATE ABBREVIATION)
(per X026);
HH's **LAST IW 2ND RESIDENCE CITY** (per X029), **STATE** (STATE ABBREVIATION)
(per X030)

R's **LAST IW MONTH** (per Z092), **YEAR** (per Z093)

NUMBER OF CHILDREN OR STEP-CHILDREN (per A101);
R HAS **NO CHIDREN** (A101=0)

NUMBER OF GRANDCHILDREN FOR CORE OR EXIT R (NOT POST-EXIT R) (per E046);
NUMBER OF GRANDCHILDREN NOT ASKED BECAUSE ASSUMED TO BE ZERO (E046=95);
R **HAS NO GRANDCHILDREN** (E046 NOT {>0 - <81})

NUMBER OF GRANDCHILDREN FOR POST-EXIT R (per Z114)

R **OWNED A MAIN RESIDENCE OR {MOBILE {HOME AND/OR SITE}} OR FARM** AT R's **LAST IW**
(X079=1)

R **OWNED SECOND RESIDENCE** AT HH's **LAST IW** (X032 = 1)

ASK ABOUT DISPOSITION OF HOME ONLY (Z146=1);
ASK ABOUT **WILL/TRUST ONLY** (Z146=2);
ASK ABOUT **BOTH HOME AND WILL/TRUST** (Z146=3)

* A variable fieldname and code reference is shown at its first occurrence in the questionnaire, but in some cases, especially when it is common, is not shown after that.

T001 BRANCHPOINT: IF THIS IS AN EXIT INTERVIEW, GO TO T101 BRANCHPOINT

!! WILLS--FAMILY

T001

Do you currently have a will that is written and witnessed?

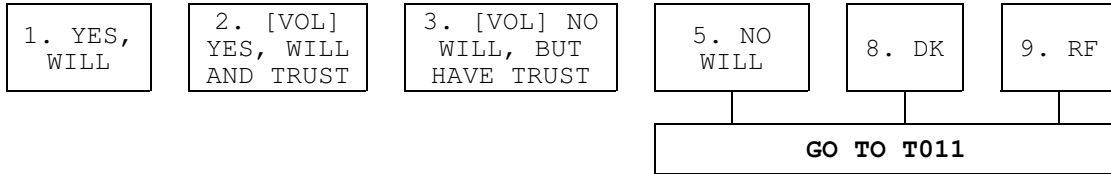

T002

Have you made provisions in your [will/will or trust/trust] for any family members other than your [husband/wife/partner]?

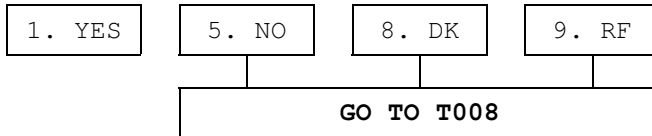

T003 BRANCHPOINT: IF R DOES NOT HAVE CHILDREN OR STEP-CHILDREN (A101=0), GO TO T006 BRANCHPOINT

T003

Does that include any child or step-child?

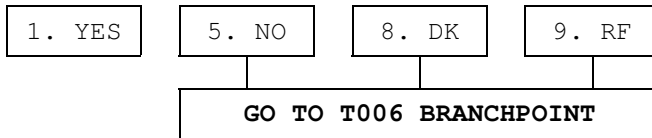

T004/T050_T004

(Which child is that?)

[IWER: CHOOSE ALL THAT APPLY. IF ONLY ONE CHILD APPEARS, SELECT AND MOVE ON.]

CHILD NAME(S) [DISPLAYED BY BLAISE FROM PREVIOUS RESPONSES]
3. THROUGH 42. CHILD NAME(S)
[ROWS PROVIDED BY BLAISE AS NECESSARY]
93. ALL CHILDREN EQUALLY
96. ALL CHILDREN — "EQUALLY" NOT MENTIONED
98. DK
99. RF

NOTE: NAMES OF ALL LIVING AND DEAD CHILDREN ARE DISPLAYED. NAMES OF SPOUSE/PARTNERS OF CHILDREN ARE NOT DISPLAYED.

T005 BRANCHPOINT: IF R REPORTED THAT MADE PROVISION FOR ALL CHILDREN EQUALLY (T004=93), GO TO T006 BRANCHPOINT

IF IWER MADE ONLY 1 SELECTION AT T004 and SELECTION AT T004 WAS NOT 96 ('ALL CHILDREN — "EQUALLY" NOT MENTIONED'), GO TO T006 BRANCHPOINT

T005

Does that document provide for all your children about equally?

1. YES	5. NO	8. DK	9. RF
--------	-------	-------	-------

T006 BRANCHPOINT: IF R DOES NOT HAVE GRANDCHILDREN (E046={0 or 95 or DK or RF}), GO TO T008

T006

Does that document include any grandchild directly?

1. YES	2. [VOL] ONLY THROUGH THEIR PARENTS	5. NO	8. DK	9. RF
GO TO T008				

T007/T051_T007

Which of your children is the parent of that grandchild?

[IWER: CHOOSE ALL THAT APPLY]

CHILD NAME(S) [DISPLAYED BY BLAISE FROM PREVIOUS RESPONSES]
3. THROUGH 42. CHILD NAME(S)
[ROWS PROVIDED BY BLAISE AS NECESSARY]
92. DECEASED CHILD
93. ALL CHILDREN
98. DK
99. RF

NOTE: NAMES OF ALL LIVING AND DEAD CHILDREN ARE DISPLAYED. NAMES OF SPOUSE/PARTNERS OF CHILDREN ARE NOT DISPLAYED.

T008

Have you made provisions for any charities in your will or trust?

1. YES	5. NO	8. DK	9. RF
--------	-------	-------	-------

!! LIFE INSURANCE

T011

Do you have any life insurance, including individual or group policies?

1. YES	5. NO	8. DK	9. RF	
<table border="1"> <tr> <td>GO TO T036</td> </tr> </table>				GO TO T036
GO TO T036				

T012

How many different life insurance policies do you have?

[IWER: INCLUDE INDIVIDUAL POLICIES, GROUP POLICIES, OR PAID-UP POLICIES IF R ASKS]

1. ONE	2. TWO	3. THREE	4. FOUR	5. FIVE OR MORE	8. DK	9. RF
--------	--------	----------	---------	-----------------	-------	-------

T013

(Altogether), what is the total face value of (this policy/these policies), that is, the amount of money the beneficiary would get if you were to die?

[IWER: DO NOT PROBE DK/RF]

	DK	RF
AMOUNT		
GO TO T017		

T014-T016 Unfolding Sequence

Question text: Does it amount to less than \$____ , more than \$____ , or what?

PROCEDURES: 3Up, 2Up1Down, 1Up2Down
 BREAKPOINTS: \$2,500, \$25,000, \$50,000, \$250,000
 RANDOM ENTRY POINTS: \$2,500, \$25,000, \$50,000
 ENTRY POINT ASSIGNMENT 1 or 2 or {NOT 1 and NOT 2} AT Z087
 ORDER OF ENTRY POINT ASSIGNMENTS AND PROCEDURES CORRESPOND

T017/T052_T017

Who are the beneficiaries of (this policy/all of these policies)?

[IWER: CHOOSE ALL THAT APPLY]

CHILD NAME(S) [DISPLAYED BY BLAISE FROM PREVIOUS RESPONSES]
3. THROUGH 42. CHILD NAME(S) [ROWS PROVIDED BY BLAISE AS NECESSARY]
91. R'S SPOUSE/PARTNER
92. DECEASED CHILD
93. ALL CHILDREN
94. ALL GRANDCHILDREN
97. OTHER (SPECIFY) [T045]
98. DK
99. RF

NOTE: NAMES OF ALL LIVING AND DEAD CHILDREN ARE DISPLAYED. NAMES OF SPOUSE/PARTNERS OF CHILDREN ARE NOT DISPLAYED.

T018

[Is this a life insurance policy that builds/Are any of these life insurance policies ones that build] up a cash value that you can borrow against, or that you would receive if the policy were to be cancelled?

DEFINITION: THESE ARE SOMETIMES CALLED 'WHOLE LIFE' OR 'STRAIGHT LIFE POLICIES.'

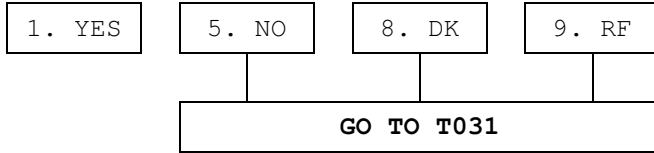

T019 BRANCHPOINT: IF R HAS ONLY ONE LIFE INSURANCE POLICY (T012=1), GO TO T024

T019

(How many such policies do you have?)

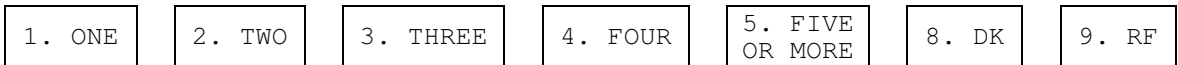

T020

What is the current face value of [these policies/this policy]?

[IWER: DO NOT PROBE DK/RF]

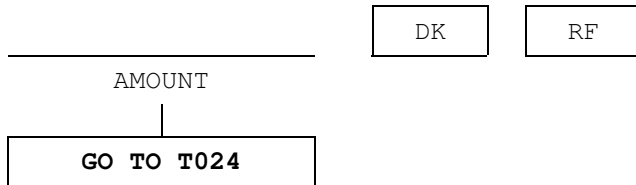

T021-T023 Unfolding Sequence

Question text: Does it amount to less than \$____ , more than \$____ , or what?

PROCEDURES: 3Up, 2Up1Down, 1Up2Down

BREAKPOINTS: \$2,500, \$25,000, \$50,000, \$250,000

RANDOM ENTRY POINTS: \$2,500, \$25,000, \$50,000

ENTRY POINT ASSIGNMENT 1 or 2 or {NOT 1 and NOT 2} AT Z087

ORDER OF ENTRY POINT ASSIGNMENTS AND PROCEDURES CORRESPOND

T024

(Altogether) about how much do you pay for [these policies/this policy] each month or year?

[IWER: ENTER 0 IF PAID UP OR NO PREMIUM PAYMENTS]

AMOUNT	0 NO PREMIUM PAYMENTS	DK	RF
GO TO T025	GO TO T029 BRANCHPOINT		

T026-T028 Unfolding Sequence

Question text: Does it amount to less than \$____ per month, more than \$____ per month, or what?

PROCEDURES: 2Up2Down, 1Up3Down

BREAKPOINTS: \$20, \$50, \$100, \$200, \$400

RANDOM ENTRY POINTS: \$100, \$200

ENTRY POINT ASSIGNMENT 1 or {NOT 1} AT X501

ORDER OF ENTRY POINT ASSIGNMENTS AND PROCEDURES CORRESPOND

T025

PER:

1. MONTH	2. YEAR	8. DK	9. RF
----------	---------	-------	-------

T029 BRANCHPOINT: IF R HAS ONLY ONE LIFE INSURANCE POLICY (T012=1), GO TO T031

T029/T053_T029

Who are the beneficiaries of [these policies/this policy]?

[IWER: CHOOSE ALL THAT APPLY]

CHILD NAME(S) [DISPLAYED BY BLAISE FROM PREVIOUS RESPONSES]
3. THROUGH 42. CHILD NAME(S) [ROWS PROVIDED BY BLAISE AS NECESSARY]
91. R'S SPOUSE/PARTNER
92. DECEASED CHILD
93. ALL CHILDREN
94. ALL GRANDCHILDREN
97. OTHER (SPECIFY) [T030]
98. DK
99. RF

NOTE: NAMES OF ALL LIVING AND DEAD CHILDREN ARE DISPLAYED. NAMES OF SPOUSE/PARTNERS OF CHILDREN ARE NOT DISPLAYED.

!! NEW LIFE INSURANCE

T031

[Since R's LAST IW MONTH, YEAR/In the last 2 years] have you obtained any new life insurance policies?

1. YES	5. NO	8. DK	9. RF
GO TO T036			

T032

What is the total face value of (this policy/all of these policies)?

[IWER: DO NOT PROBE DK/RF]

AMOUNT

|

DK	RF
----	----

|

GO TO T036

T033-T035 Unfolding Sequence

Question text: Does it amount to less than \$____ , more than \$____ , or what?

PROCEDURE: 2Up1Down

BREAKPOINTS: \$2,500, **\$25,000**, \$50,000, \$250,000

ENTRY POINT: \$25,000

!! LAPSED LIFE INSURANCE

T036

[Since R's LAST IW MONTH, YEAR/In the last 2 years] have you allowed any life insurance policies to lapse or have any been cancelled?

1. YES	5. NO	8. DK	9. RF
--------	-------	-------	-------

|

GO TO T047 (T ASSIST)

T037

What was the total face value of (this policy/all of these policies)?

[IWER: DO NOT PROBE DK/RF]

AMOUNT

|

DK	RF
----	----

|

GO TO T041

T038-T040 Unfolding Sequence

Question text: Does it amount to less than \$____ , more than \$____ , or what?

PROCEDURE: 1Up2Down

BREAKPOINTS: \$2,500, \$25,000, **\$50,000**, \$250,000

ENTRY POINT: \$50,000

T041

Was this lapse or cancellation something you chose to do, or was it done by the provider, your employer, or someone else?

1. R'S CHOICE	2. PROVIDER/EMPLOYER/ SOMEONE ELSE CHOSE	8. DK	9. RF
---------------	---	-------	-------

GO TO T047 (T ASSIST)

T042

Was it because the policy was too expensive, because you did not need the coverage or some other reason?

1. TOO EXPENSIVE	2. COVERAGE NOT NEEDED	3. R GOT NEW POLICY
------------------	------------------------	---------------------

7. OTHER (SPECIFY) _____ T048 (Tag#=T042.5)	8. DK	9. RF
---	-------	-------

T043

Did you receive any cash when the policy was cancelled or allowed to lapse?

1. YES	5. NO	8. DK	9. RF
--------	-------	-------	-------

GO TO T047 (T ASSIST)

T044

About how much cash did you receive?

AMOUNT

DK	RF
----	----

T047

T ASSIST

IWER: HOW OFTEN DID R RECEIVE ASSISTANCE WITH ANSWERS IN SECTION T — WILLS AND TRUSTS?

1. NEVER	2. A FEW TIMES	3. MOST OR ALL OF THE TIME	4. THE SECTION WAS DONE BY A PROXY REPORTER
----------	----------------	-------------------------------	--

!! EXIT 1st HOME DISPOSAL - FIRST RESIDENCE

T101 BRANCHPOINT: IF THIS IS NOT AN EXIT INTERVIEW,
GO TO SECTION U

IF THIS IS A POST-EXIT INTERVIEW (Z145={2 or 3 or 4}) and WE
DON'T NEED TO ASK ABOUT THE HOME DISPOSITION (Z146 {NOT 1 and
NOT 3}), GO TO T155 BRANCHPOINT

IF THIS IS NOT A POST-EXIT IW (Z145 {NOT 2 and NOT 3 and NOT
4})) and R DID NOT OWN RESIDENCE/MOBILE HOME/FARM IN HH's LAST
IW (X079 NOT 1), GO TO T124 BRANCHPOINT

T101

IF {R's LAST IW SPOUSE/PARTNER WAS NOT LIVING WHEN S/HE DIED (A023 NOT
1) and PROXY IS NOT A SURVIVING SPOUSE/PARTNER (A009 NOT 2)} or R {WAS
REMARRIED WHEN S/HE DIED (A026=1) and WAS NOT COUPLED AT HH's LAST IW
(X066 {NOT 1 and NOT 3}):

Our records show that R's FIRST NAME (per X058) owned a home in HH's
LAST IW 1ST RESIDENCE CITY (X025), STATE (STATE ABBREVIATION) (X026) in
[R's LAST IW MONTH (per X092), YEAR (per X093)/the last two years].

IF R WAS MARRIED/PARTNERED HH's LAST IW (X066={1 or 3}) and PROXY IS R's
SURVIVING SPOUSE/PARTNER (A009=2):

Our records show that you and R's FIRST NAME owned a home in HH's
LAST IW 1ST RESIDENCE CITY, STATE (STATE ABBREVIATION) in [R's LAST IW
MONTH, YEAR/the last two years].

OTHERWISE, IF {THIS IS NOT A POST-EXIT AND R's LAST IW SPOUSE/PARTNER
WAS LIVING WHEN S/HE DIED (A023=1) and PROXY IS NOT A SURVIVING
SPOUSE/PARTNER (A009 NOT 2)}:

Our records show that (R's FIRST NAME) and [his/her]
[husband/wife/partner] owned a home in HH's LAST IW 1ST RESIDENCE CITY,
STATE (STATE ABBREVIATION) in [R's LAST IW MONTH, YEAR/the last two
years].

ASK ALL PROXIES:

Please, let me confirm, did R's FIRST NAME still own that home when
[he/she] died?

1. YES

2. [VOL] RECORDS
INCORRECT

5. NO

8. DK

9. RF

GO TO T111

GO TO T124
BRANCHPOINT

!! EXIT NO 1st HOME AT DEATH

T066 (Tag#=T101.5)
Did R's FIRST NAME ever own it?

1. YES	5. NO	8. DK	9. RF
GO TO T124 BRANCHPOINT			

T102

What happened to that home — did R's FIRST NAME sell it, give it to someone, or what?

1. GAVE TO SOMEONE	2. SOLD	7. OTHER (SPECIFY) _____	8. DK	9. RF
	GO TO T107	T103	GO TO T124 BRANCHPOINT	

T104

To whom did [he/she] give the house, (that is, what was their relationship to R's FIRST NAME)?

[IWER: CHOOSE ALL THAT APPLY]

1. SPOUSE/PARTNER	2. CHILD/ CHILD-IN-LAW	3. OTHER RELATIVE	4. FRIEND	
5. CHARITY	6. GRANDCHILD	7. SOMEONE ELSE	8. DK	9. RF

T105 BRANCHPOINT: IF PROXY DID NOT REPORT THAT R GAVE THE HOUSE TO A CHILD/GRANDCHILD (T104 {NOT 2 and NOT 6}), GO TO T107

T105/T054-T105

(Which child is that?)

[IWER: CHOOSE ALL THAT APPLY]

IF GRANDCHILD:

Which child of R's FIRST NAME (or [you/[his/her] [husband/wife/partner]]) is the parent of that grandchild?

CHILD NAME(S) [DISPLAYED BY BLAISE FROM PREVIOUS RESPONSES]
3. THROUGH 42. CHILD NAME(S) [ROWS PROVIDED BY BLAISE AS NECESSARY]
92. DECEASED CHILD
93. ALL CHILDREN
97. OTHER (SPECIFY) [T106]
98. DK
99. RF

NOTE: NAMES OF ALL LIVING AND DEAD CHILDREN ARE DISPLAYED. NAMES OF SPOUSE/PARTNERS OF CHILDREN ARE NOT DISPLAYED.

T107

IF R SOLD THE HOME (T102=2)
What was the selling price?

OTHERWISE:

What was the value of that house? I mean, what would it have brought if it had been sold?

[IWER: DO NOT PROBE DK/RF]

AMOUNT

T108-T110 Unfolding Sequence

Question text: Did it amount to a total of less than \$____, more than \$____, or what?

PROCEDURES: 1Up1Down, 2Down

BREAKPOINTS: \$15,000, \$50,000, \$200,000

RANDOM ENTRY POINTS: \$50,000, \$200,000

ENTRY POINT ASSIGNMENT 1 or {NOT 1} AT X502

ORDER OF ENTRY POINT ASSIGNMENTS AND PROCEDURES CORRESPOND

T111 BRANCHPOINT: GO TO T124 BRANCHPOINT

!! EXIT 1st HOME DISPOSAL AFTER DEATH

T111

What happened to that home after *R's FIRST NAME's* death:

IF PROXY IS THE SURVIVING SPOUSE/PARTNER (A009=2):

Do you own it now, was it sold, was it inherited by someone else, has it not yet been disposed of, or what?

IF {THIS IS NOT A POST-EXIT AND PROXY IS NOT *R's* SPOUSE/PARTNER AND *R's* SPOUSE/PARTNER IS STILL LIVING} (A023=1):

Does [his/her] [husband/wife/partner] own it now, was it sold, was it inherited by someone else, has it not yet been disposed of, or what?

OTHERWISE:

Was it sold, was it inherited by someone else, has it not yet been disposed of, or what?

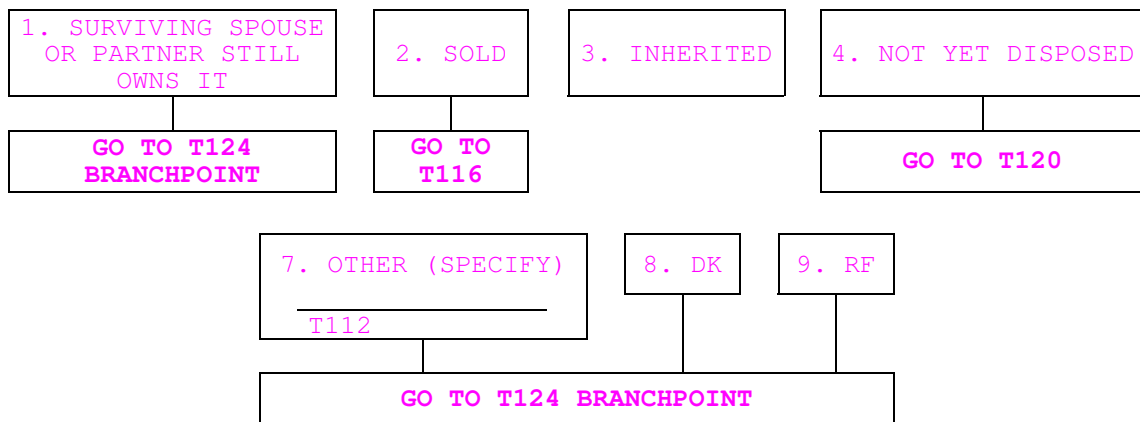

!! EXIT 1st HOME INHERITED

T113

Who inherited the house, (that is, what was their relationship to *R's FIRST NAME*)?

[IWER: CHOOSE ALL THAT APPLY]

- | | | | |
|-------------------|-----------------------|-------------------|-----------|
| 1. SPOUSE/PARTNER | 2. CHILD/CHILD-IN-LAW | 3. OTHER RELATIVE | 4. FRIEND |
| 5. CHARITY | 6. GRANDCHILD | 7. SOMEONE ELSE | 8. DK |
| | | | 9. RF |

T114 BRANCHPOINT: IF PROXY DID NOT REPORT THAT CHILD/GRANDCHILD INHERITED THE HOUSE (T113 {NOT 2 and NOT 6}), GO TO T116

T114/T055_T114

(Which child is that?)

[IWER: CHOOSE ALL THAT APPLY]

IF GRANDCHILD:

Which child of *R's FIRST NAME* (or [you/[his/her] [husband/wife/partner]]) is the parent of that grandchild?

CHILD NAME(S) [DISPLAYED BY BLAISE FROM PREVIOUS RESPONSES]
3. THROUGH 42. CHILD NAME(S) [ROWS PROVIDED BY BLAISE AS NECESSARY]
92. DECEASED CHILD
93. ALL CHILDREN
97. OTHER (SPECIFY) [T115]
98. DK
99. RF

NOTE: NAMES OF ALL LIVING AND DEAD CHILDREN ARE DISPLAYED. NAMES OF SPOUSE/PARTNERS OF CHILDREN ARE NOT DISPLAYED.

!! EXIT 1st HOME SOLD

T116

IF R SOLD THE HOME (T111=2)
What was the selling price?

OTHERWISE:

What was the value of that house? I mean, what would it have brought if it had been sold?

[IWER: DO NOT PROBE DK/RF]

AMOUNT

T117-T119 Unfolding Sequence

Question text: Did it amount to a total of less than \$____, more than \$____, or what?

PROCEDURES: 1Up1Down, 2Down

BREAKPOINTS: \$15,000, **\$50,000**, \$200,000

RANDOM ENTRY POINTS: \$50,000, \$200,000

ENTRY POINT ASSIGNMENT 1 or {NOT 1} AT X503

ORDER OF ENTRY POINT ASSIGNMENTS AND PROCEDURES CORRESPOND

T120 BRANCHPOINT: GO TO T124 BRANCHPOINT

!! EXIT HOME NOT DISPOSED

T120

Is that home now vacant, or is someone living there?

GO TO T124
BRANCHPOINT

GO TO T124
BRANCHPOINT

T121

Who lives in the house, (that is, what was their relationship to R's FIRST NAME)?

[IWER: CHOOSE ALL THAT APPLY]

1. SPOUSE/PARTNER

2. CHILD/
CHILD-IN-LAW

3. OTHER RELATIVE

4. FRIEND

5. CHARITY

6. GRANDCHILD

7. SOMEONE ELSE

8. DK

9. RF

T122 BRANCHPOINT: IF PROXY DID NOT REPORT THAT CHILD/GRANDCHILD LIVES IN HOUSE (T121 {NOT 2 and NOT 6}), GO TO T124 BRANCHPOINT

T122/T056_T121

(Which child is that?)

[IWER: CHOOSE ALL THAT APPLY]

IF GRANDCHILD:

Which child of R's FIRST NAME (or [you/[his/her]
[husband/wife/partner]]) is the parent of that grandchild?

CHILD NAME(S) [DISPLAYED BY BLAISE FROM PREVIOUS RESPONSES]
3. THROUGH 42. CHILD NAME(S) [ROWS PROVIDED BY BLAISE AS NECESSARY]
92. DECEASED CHILD
93. ALL CHILDREN
97. OTHER (SPECIFY) [T123]
98. DK
99. RF

NOTE: NAMES OF ALL LIVING AND DEAD CHILDREN ARE DISPLAYED. NAMES OF SPOUSE/PARTNERS OF CHILDREN ARE NOT DISPLAYED.

!! EXIT HOME DISPOSAL - SECOND RESIDENCE

T124 BRANCHPOINT: IF THIS IS A POST-EXIT INTERVIEW (Z145={2 or 3 or 4}),
GO TO T155 BRANCHPOINT

IF R DID NOT HAVE A SECOND RESIDENCE AT HH'S LAST IW
(X032 NOT 1), GO TO T148

T124

IF {R's LAST IW SPOUSE/PARTNER WAS NOT LIVING WHEN S/HE DIED (A023 NOT 1) and PROXY IS NOT A SURVIVING SPOUSE/PARTNER (A009 NOT 2)} or R {WAS REMARRIED WHEN S/HE DIED (A026=1) and WAS NOT COUPLED AT HH'S LAST IW (X066 {NOT 1 and NOT 3}):

Our records show that R's FIRST NAME owned a home in HH's LAST IW 2ND RESIDENCE CITY, STATE (STATE ABBREVIATION) in [R's LAST IW MONTH, YEAR/the last two years].

IF R WAS MARRIED/PARTNERED AT HH'S LAST IW (X066={1 or 3}) and PROXY IS R's SURVIVING SPOUSE/PARTNER (A009=2):

IF PROXY IS THE SURVIVING SPOUSE/PARTNER (A009=2):

Our records show that you and R's FIRST NAME owned a home in HH's LAST IW 2ND RESIDENCE CITY (X029), STATE (STATE ABBREVIATION) (X030) in [R's LAST IW MONTH, YEAR/the last two years].

OTHERWISE, IF R's LAST IW SPOUSE/PARTNER WAS LIVING WHEN S/HE DIED (A023=1) and PROXY IS NOT A SURVIVING SPOUSE/PARTNER (A009 NOT 2):

Our records show that R's FIRST NAME and [his/her] [husband/wife/partner] owned a home in HH's LAST IW 2ND RESIDENCE CITY, STATE (STATE ABBREVIATION) in [R's LAST IW MONTH, YEAR/the last two years].

ASK ALL PROXIES:

Remind me, did [he/she] own that home when [he/she] died?

1. YES

2. [VOL] RECORDS
INCORRECT

5. NO

8. DK

9. RF

GO TO T135

GO TO T148

!! EXIT 2ND HOME DISPOSED BEFORE DEATH

T125

Did R's FIRST NAME ever own it?

1. YES	5. NO	8. DK	9. RF
GO TO T148			

T240 (Tag#=T126)

What happened to that home — did R's FIRST NAME sell it, give it to someone, or what?

1. GAVE TO SOMEONE	2. SOLD	7. OTHER (SPECIFY) _____ T241 (Tag#=T127)	8. DK	9. RF
	GO TO T131	GO TO T148		

!! EXIT 2ND HOME INHERITED BEFORE DEATH

T128

To whom did [he/she] give the house, (that is, what was their relationship to R's FIRST NAME)?

[IWER: CHOOSE ALL THAT APPLY]

1. SPOUSE/PARTNER	2. CHILD/ CHILD-IN-LAW	3. OTHER RELATIVE	4. FRIEND
5. CHARITY	6. GRANDCHILD	7. SOMEONE ELSE	8. DK
9. RF			

T129 BRANCHPOINT: IF PROXY DID NOT REPORT THAT CHILD/GRANDCHILD LIVES IN HOUSE (T128 {NOT 2 and NOT 6}), GO TO T131

T129/T056_T129

(Which child is that?)

[IWER: CHOOSE ALL THAT APPLY]

IF GRANDCHILD:

Which child of R's FIRST NAME (or [you/[his/her]
[husband/wife/partner]]) is the parent of that grandchild?

CHILD NAME(S) [DISPLAYED BY BLAISE FROM PREVIOUS RESPONSES]
3. THROUGH 42. CHILD NAME(S) [ROWS PROVIDED BY BLAISE AS NECESSARY]
92. DECEASED CHILD
93. ALL CHILDREN
97. OTHER (SPECIFY) [T130]
98. DK
99. RF

NOTE: NAMES OF ALL LIVING AND DEAD CHILDREN ARE DISPLAYED. NAMES OF SPOUSE/PARTNERS OF CHILDREN ARE NOT DISPLAYED.

!! EXIT 2ND HOME SOLD BEFORE DEATH

T131

IF R SOLD THE HOME (T240=2):
What was the selling price?

OTHERWISE:

What was the value of that house? I mean, what would it have brought if it had been sold?

[IWER: DO NOT PROBE DK/RF]

AMOUNT

T132-T134 Unfolding Sequence

Question text: Did it amount to a total of less than \$____, more than \$____, or what?

PROCEDURES: 1Up1Down, 2Down

BREAKPOINTS: \$15,000, \$50,000, \$200,000

RANDOM ENTRY POINTS: \$50,000, \$200,000

ENTRY POINT ASSIGNMENT 1 or {NOT 1} AT X504

ORDER OF ENTRY POINT ASSIGNMENTS AND PROCEDURES CORRESPOND

T135 BRANCHPOINT: GO TO T148

!! EXIT 2ND HOME DISPOSAL AFTER DEATH

T135

What happened to that home after R's FIRST NAME's death:

IF PROXY IS THE SURVIVING SPOUSE/PARTNER (A009=2):

Do you own it now, was it sold, was it inherited by someone else, has it not yet been disposed of, or what?

IF {PROXY IS NOT R's SPOUSE/PARTNER AND R's SPOUSE/PARTNER WAS STILL LIVING WHEN S/HE DIED} (A023=1):

Does [his/her] [husband/wife/partner] own it now, was it sold, was it inherited by someone else, has it not yet been disposed of, or what?

OTHERWISE:

Was it sold, was it inherited by someone else, has it not yet been disposed of, or what?

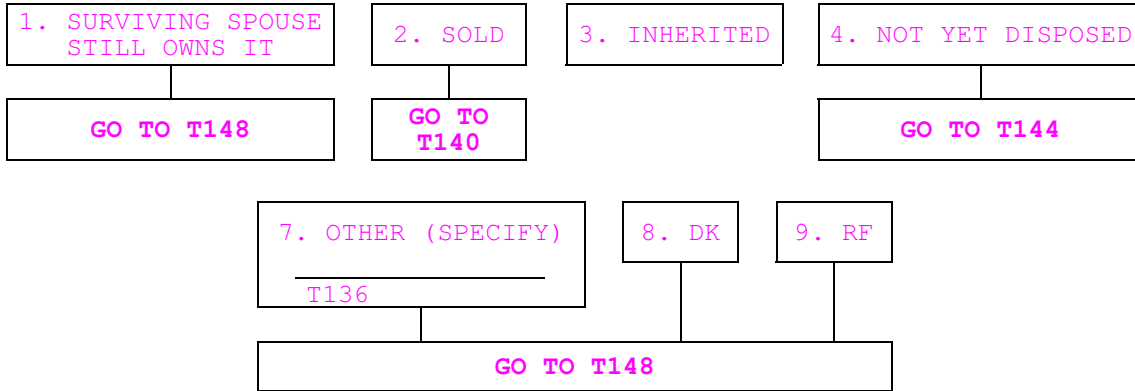

!! EXIT 2ND HOME INHERITED

T137

Who inherited the house, (that is, what was their relationship to R's FIRST NAME)?

[IWER: CHOOSE ALL THAT APPLY]

- | | | | |
|-------------------|---------------------------|-------------------|-----------|
| 1. SPOUSE/PARTNER | 2. CHILD/
CHILD-IN-LAW | 3. OTHER RELATIVE | 4. FRIEND |
| 5. CHARITY | 6. GRANDCHILD | 7. SOMEONE ELSE | 8. DK |
| | | | 9. RF |

T138 BRANCHPOINT: IF PROXY DID NOT REPORT THAT CHILD/GRANDCHILD LIVES IN HOUSE (T137 {NOT 2 and NOT 6}), GO TO T140

T138/T058_T137

(Which child is that?)

[IWER: CHOOSE ALL THAT APPLY]

IF GRANDCHILD:

Which child of R's FIRST NAME (or [you/[his/her] [husband/wife/partner]]) is the parent of that grandchild?

CHILD NAME(S) [DISPLAYED BY BLAISE FROM PREVIOUS RESPONSES]
3. THROUGH 42. CHILD NAME(S) [ROWS PROVIDED BY BLAISE AS NECESSARY]
92. DECEASED CHILD
93. ALL CHILDREN
97. OTHER (SPECIFY) [T139]
98. DK
99. RF

NOTE: NAMES OF ALL LIVING AND DEAD CHILDREN ARE DISPLAYED. NAMES OF SPOUSE/PARTNERS OF CHILDREN ARE NOT DISPLAYED.

!! EXIT 2ND HOME SOLD

T140

IF R SOLD THE HOME (T135=2):
What was the selling price?

OTHERWISE:
What was the value of that house? I mean, what would it have brought if it had been sold?

[IWER: DO NOT PROBE DK/RF]

AMOUNT

DK	RF
----	----

|

GO TO T148

T141-T143 Unfolding Sequence

Question text: Did it amount to a total of less than \$____, more than \$____, or what?

PROCEDURE: 1Up1Down
BREAKPOINTS: \$15,000, \$50,000, \$200,000
ENTRY POINT: \$50,000

T144 BRANCHPOINT: GO TO T148

!! EXIT 2ND HOME NOT DISPOSED YET

T144

Is that home now vacant, or is someone living there?

1. VACANT	5. OCCUPIED	8. DK	9. RF

GO TO T148

GO TO T148

T145

Who lives in the house, (that is, what was their relationship to R's FIRST NAME)?

[IWER: CHOOSE ALL THAT APPLY]

1. SPOUSE/PARTNER

2. CHILD/
CHILD-IN-LAW

3. OTHER RELATIVE

4. FRIEND

5. CHARITY

6. GRANDCHILD

7. SOMEONE ELSE

8. DK

9. RF

T146 BRANCHPOINT: IF PROXY DID NOT REPORT THAT CHILD/GRANDCHILD LIVES IN HOUSE (T145 {NOT 2 and NOT 6}), GO TO T148

T146/T059_T146

(Which child is that?)

[IWER: CHOOSE ALL THAT APPLY]

IF GRANDCHILD:

Which child of R's FIRST NAME (or [you/[his/her]
[husband/wife/partner]]) is the parent of that grandchild?

CHILD NAME(S) [DISPLAYED BY BLAISE FROM PREVIOUS RESPONSES]
3. THROUGH 42. CHILD NAME(S) [ROWS PROVIDED BY BLAISE AS NECESSARY]
92. DECEASED CHILD
93. ALL CHILDREN
97. OTHER (SPECIFY) [T147]
98. DK
99. RF

NOTE: NAMES OF ALL LIVING AND DEAD CHILDREN ARE DISPLAYED. NAMES OF SPOUSE/PARTNERS OF CHILDREN ARE NOT DISPLAYED.

!! EXIT DEATH EXPENSES

T148

I asked you earlier about expenses incurred for the health care that R's FIRST NAME received. Now I want to know about expenses associated with [his/her] death, for funeral expenses, legal fees, and so on.

What were the total expenses associated with the death for things of that type?

[IWER: DO NOT PROBE DK/RF]

[IWER: ENTER 99996 IF NOT SETTLED YET]

	99996 NOT SETTLED YET	0	DK	RF
AMOUNT				
GO TO T152		GO TO T155 BRANCHPOINT		

T149-T151 Unfolding Sequence

Question text: Did it amount to less than \$____, more than \$____, or what?

PROCEDURES: 2Up1Down, 1Up2Down

BREAKPOINTS: \$1,000, \$5,000, \$25,000, \$100,000

RANDOM ENTRY POINTS: \$5,000, \$25,000

ENTRY POINT ASSIGNMENT 1 or {NOT 1} AT X505

ORDER OF ENTRY POINT ASSIGNMENTS AND PROCEDURES CORRESPOND

T152

Excluding life insurance, were any of these costs covered by insurance?

1. YES	5. NO	8. DK	9. RF
GO TO T155 BRANCHPOINT			

T153

How much did insurance pay?

	OR		DK	RF
T153 AMOUNT		T154 PERCENT		

!! EXIT INHERITANCE

T155 BRANCHPOINT: IF WE DON'T NEED TO ASK ABOUT THE WILL/TRUST
(Z146 {NOT 2 and NOT 3}), GO TO T173

T155

Sometimes people make provision to leave things to specific family members if something happens to them, others do not. Because we are trying to get a complete picture of family situations, I have a few questions about inheritance.

Before [his/her] death, had *R's FIRST NAME* put any of [his/her] assets into a trust?

- | | | | |
|--------|-------|-------|-------|
| 1. YES | 5. NO | 8. DK | 9. RF |
|--------|-------|-------|-------|

T156

IF R PUT ASSETS INTO TRUST (T155=1):
In addition to the trust, did *R's FIRST NAME* have a will that was written and witnessed?

OTHERWISE:

Did *R's FIRST NAME* have a will that was written and witnessed?

- | | | | |
|------------------------|-------|-------|-------|
| 1. YES | 5. NO | 8. DK | 9. RF |
| GO TO T161 BRANCHPOINT | | | |

T157

Has [his/her] will been probated?

- | | | |
|--|---------------------------------|--|
| 1. YES | 2. [VOL] NO: PROBATE NOT NEEDED | 3. [VOL] NO: NO ASSETS REMAINED TO BE PROBATED |
| GO TO T161 BRANCHPOINT | | |
| 4. [VOL] NO: ALL ASSETS WERE HELD IN JOINT TENANCY OR IN A TRUST | | 5. NO |
| GO TO T161 BRANCHPOINT | | |
| 7. [VOL] R DISPUTES RECORD | 8. DK | 9. RF |
| GO TO T161 BRANCHPOINT | | |

T158

In what state was it probated?

_____	OTHER COUNTRY (SPECIFY) _____	98. DK	99. RF
STATE	T159		
	GO TO T161 BRANCHPOINT	GO TO T161 BRANCHPOINT	

NOTE: THE IWER SELECTS FROM A MENU OF STATE NAMES, INCLUDING WASHINGTON, D.C., AND PUERTO RICO.

T160

In what county was it probated?

_____	98. DK	99. RF
COUNTY		

T161 BRANCHPOINT: IF R HAD {A TRUST or A PROBATED WILL} ({T155 or T157}=1), GO TO T163 LOOP BRANCHPOINT

!! EXIT DISTRIBUTION OF ASSETS

T161

The next questions are about R's FIRST NAME's assets and possessions, excluding any life insurance.

Have they been divided up among the heirs, have they not yet been distributed, was there nothing of much value to distribute, or what?

1. DIVIDED AMONG THE HEIRS, OR RETAINED BY THOSE WITH JOINT TENANCY	2. NOT YET DISTRIBUTED		
3. NOTHING MUCH OF VALUE	7. OTHER (SPECIFY) _____	8. DK	9. RF
	T162		

T163 LOOP BRANCHPOINT: IF {R HAD NEITHER A TRUST NOR A PROBATED WILL ({T155 and T157} NOT 1)} and {{ASSETS/POSSESSIONS WERE NOT DIVIDED AMONG HEIRS and THE RESPONSE WAS NOT OTHER (SPECIFY)} (T161 {NOT 1 and NOT 7})}, GO TO T181 BRANCHPOINT

IF R WAS NOT PART OF A COUPLE (X065 {NOT 1 and NOT 3}), GO TO T164 BRANCHPOINT

T163 THROUGH T908-8 ARE ASKED FOR POTENTIAL BENEFICIARIES OF R'S ESTATE.

T163

IF R HAD {A TRUST and/or A WILL} ({T155 and T156}=1 or T155=1 or T156=1):
Did [he/she] make provisions in [either the trust or the will/the trust/the will] for [you/[[his/her] [husband/wife/partner]]]?

OTHERWISE:

Were any of [his/her] possessions or assets left to [you/[[his/her] [husband/wife/partner]]]?

1. YES	5. NO	8. DK	9. RF
GO TO T164 BRANCHPOINT			

***BEGINNING OF BLOCK_1: AMOUNT TO SPOUSE/PARTNER
(T902_1 - T908_1)

T902_1

Excluding any life insurance, how much did [you/[[his/her] [husband/wife/partner]]] receive from [his/her] estate?

[IWER: ACCEPT EITHER A DOLLAR AMOUNT OR A PERCENTAGE]

[IWER: DO NOT PROBE DK/RF]

_____	OR	_____	DK	RF
T902_1		T903_1		
AMOUNT		PERCENT		
GO TO T164 BRANCHPOINT				

T904_1

Was it more than half of [his/her] estate?

1. YES	5. NO	8. DK	9. RF
	GO TO T907_1	GO TO T164 BRANCHPOINT	

T905_1

Was it more than 75 percent of [his/her] estate?

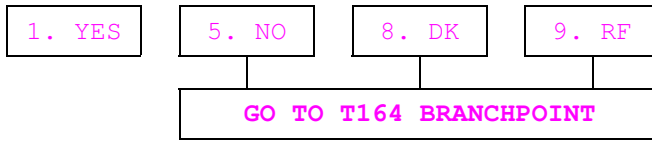

T906_1

Was it more than 90 percent of [his/her] [his/her] estate?

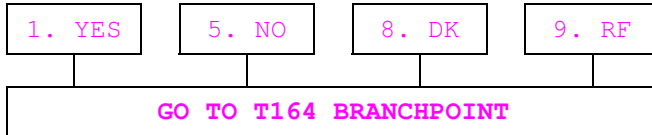

T907_1

Was it more than 25 percent of [his/her] estate?

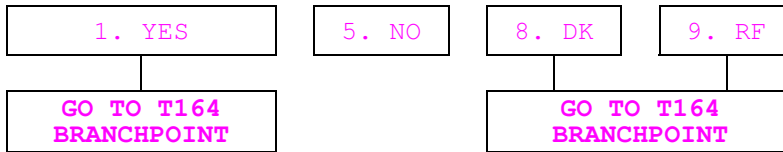

T908_1

Was it more than 10 percent of [his/her] estate?



***END OF **BLOCK_1**: AMOUNT TO SPOUSE/PARTNER (T902_1 - T908_1)

T164 BRANCHPOINT: IF R DOES NOT HAVE ANY CHILDREN (A101=0) and {{THIS IS A NEW EXIT IW (A007=5 and {Z145 {NOT 2 and NOT 3 and NOT 4}}) and {PROXY DID NOT REPORT THAT R HAD GRANDCHILDREN (E046 NOT {>0 - <81}}) or {THIS IS A POST-EXIT IW (Z145={2 or 3 or 4}) and R WAS NOT REPORTED IN A PREVIOUS WAVE TO HAVE GRANDCHILDREN (Z114 NOT {>0 - <81}})}, GO TO T168

T164

IF R HAD {A TRUST and/or A WILL} ({T155 and T156}=1 or T155=1 or T156=1):
(Again,) excluding any life insurance, did [he/she] make provisions in [either the trust or the will/the trust/the will] for any of [his/her] [children or grandchildren (or great-grandchildren)/ children/grandchildren (or great-grandchildren)]?

OTHERWISE:

(Again,) excluding any life insurance, were any of [his/her] (possessions) left to any of [his/her] [children or grandchildren (or great-grandchildren)/ children/grandchildren (or great-grandchildren)]?

[IWER: PLEASE RECORD ANY INFORMATION ABOUT ULTIMATE BENEFICIARIES IN F2 COMMENTS]

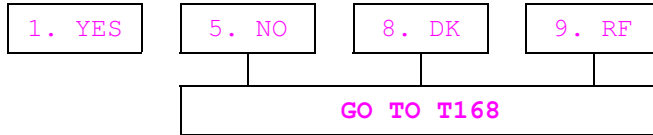

T165 BRANCHPOINT: IF R HAS FEWER THAN 2 CHILDREN (A101 ≤ 1), GO TO T166 BRANCHPOINT

T165

Did R's FIRST NAME's will provide equally for all of [his/her] children and their families?

[IWER: WE ARE INTERESTED IN THE TOTAL AMOUNT GIVEN TO EACH OF R'S CHILDREN AND THEIR SPOUSES AND CHILDREN.]



T166 BRANCHPOINT: IF R HAS ONLY ONE GRANDCHILD (E046=1 or Z114=1), ASSIGN 1 TO T166 AND GO TO T902_2

IF THIS IS A NEW EXIT R and R DOES NOT HAVE MORE THAN ONE GRANDCHILD (E046 NOT {>1 - <81}) or THIS IS A POST-EXIT R and R WAS NOT REPORTED IN A PREVIOUS WAVE TO HAVE MORE THAN ONE GRANDCHILD (Z114 NOT {>1 - <81}), GO TO T902_2 BRANCHPOINT

T166

Did [he/she] leave the same amount to each of [his/her] grandchildren?

1. YES	5. NO	8. DK	9. RF
--------	-------	-------	-------

T902_2 BRANCHPOINT: IF R HAS ONLY ONE CHILD (A101=1) or R LEFT THE SAME AMOUNT TO EACH {CHILD (T165=1) or GRANDCHILD (T166=1)}, CONTINUE ON TO T902_2
 OTHERWISE, GO TO BEGINNING OF T902_3 LOOP

***BEGINNING OF **BLOCK_2: SAME AMOUNT TO ALL CHILDREN**
 (T902_2 - T908_2)

T902_2

Altogether, how much did [he/she] leave for [his/her] [child (grandchild)/children (grandchildren)]?

[IWER: ACCEPT EITHER A DOLLAR AMOUNT OR A PERCENTAGE]

[IWER: DO NOT PROBE DK/RF]

	OR			DK	RF
T902_2 AMOUNT		T903_2 PERCENT			

GO TO T168	GO TO T168
------------	------------

T904_2

Was it more than half of [his/her] estate?

1. YES	5. NO	8. DK	9. RF
	GO TO T907_2	GO TO T168	

T905_2

Was it more than 75 percent of [his/her] estate?

1. YES	5. NO	8. DK	9. RF
GO TO T168			

T906_2

Was it more than 90 percent of [his/her] estate?

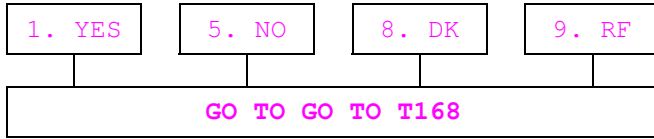

T907_2

Was it more than 25 percent of [his/her] estate?

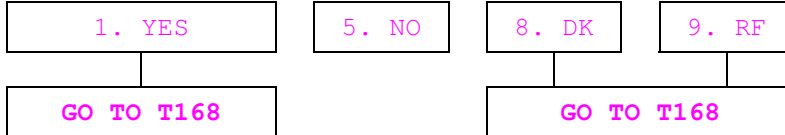

T908_2

Was it more than 10 percent of [his/her] estate?

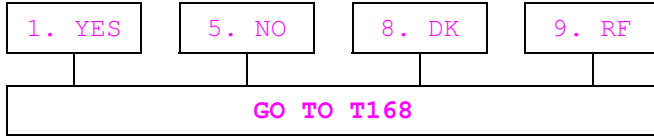

***END OF **BLOCK_2**: SAME AMOUNT TO ALL CHILDREN (T902_2 - T908_2)

T902_3 LOOP BRANCHPOINT: GO TO T168

***BEGINNING OF T902_3 LOOP: ESTATE DISPERSAL TO EACH CHILD

T902_2 - T908_2 ARE ASKED FOR EACH CHILD

***BEGINNING OF BLOCK_3: AMOUNT TO EACH CHILD

(T902_3 - T908_3)

NOTE: THIS BLOCK IS REPEATED FOR EACH CHILD LISTED FOR A HOUSEHOLD.

T902_3

(Excluding any life insurance,) how much did [he/she] leave for CHILDn's NAME and (his/her) family?

[IWER: ACCEPT EITHER A DOLLAR AMOUNT OR A PERCENTAGE]

[IWER: DO NOT PROBE DK/RF]

_____ OR _____

DK	RF
----	----

T902_3 AMOUNT T903_3 PERCENT

GO TO END OF T902_3 LOOP (AFTER T908_3)

T904_3

Was it more than half of [his/her] estate?

1. YES	5. NO	8. DK	9. RF
--------	-------	-------	-------

GO TO T907_3

GO TO END OF T902_3 LOOP (AFTER T908_3)

T905_3

Was it more than 75 percent of [his/her] estate?

1. YES	5. NO	8. DK	9. RF
--------	-------	-------	-------

GO TO END OF T902_3 LOOP (AFTER T908_3)

T906_3

Was it more than 90 percent of [his/her] estate?

1. YES	5. NO	8. DK	9. RF
--------	-------	-------	-------

GO TO END OF T902_3 LOOP (AFTER T902_3)

T907_3

Was it more than 25 percent of [his/her] estate?

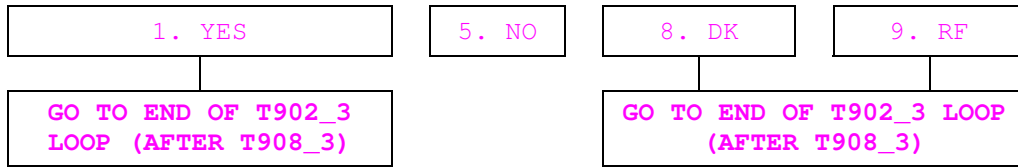

T908_3

Was it more than 10 percent of [his/her] estate?



***END OF **BLOCK_3**: AMOUNT TO EACH CHILD (T902_3 - T908_3)

***END OF T902_3 LOOP: ESTATE DISPERSAL TO EACH CHILD

IF THERE ARE NO MORE CHILDREN, CONTINUE ON TO T168. OTHERWISE, GO BACK TO BEGINNING OF T902_3 LOOP

T168

IF R HAD {A TRUST and/or A WILL} ({T155 and T156}=1 or T155=1 or T156=1):
(Excluding any life insurance,) did [he/she] make provisions in [either the trust or the will/the trust/the will] for charities?

OTHERWISE:
(Excluding any life insurance,) were any of [his/her] (possessions) left to charities?

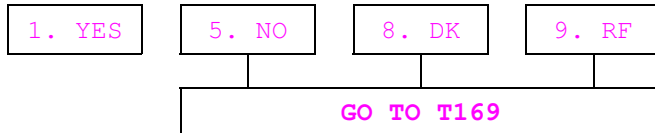

***BEGINNING OF **BLOCK_4: AMOUNT TO CHARITIES**
(T902_4 - T908_4)

T902_4

How much did charities receive from [his/her] estate?

[IWER: ACCEPT EITHER A DOLLAR AMOUNT OR A PERCENTAGE]

[IWER: DO NOT PROBE DK/RF]

_____	OR	_____	<input type="text" value="DK"/>	<input type="text" value="RF"/>
T902_4		T903_4		
AMOUNT		PERCENT		
<input type="text" value="GO TO T169"/>				

T904_4

Was it more than half of [his/her] estate?

<input type="text" value="1. YES"/>	<input type="text" value="5. NO"/>	<input type="text" value="8. DK"/>	<input type="text" value="9. RF"/>
	<input type="text" value="GO TO T907_4"/>		<input type="text" value="GO TO T169"/>

T905_4

Was it more than 75 percent of [his/her] estate?

<input type="text" value="1. YES"/>	<input type="text" value="5. NO"/>	<input type="text" value="8. DK"/>	<input type="text" value="9. RF"/>
<input type="text" value="GO TO T169"/>			

T906_4

Was it more than 90 percent of [his/her] estate?

<input type="text" value="1. YES"/>	<input type="text" value="5. NO"/>	<input type="text" value="8. DK"/>	<input type="text" value="9. RF"/>
<input type="text" value="GO TO T169"/>			

T907_4

Was it more than 25 percent of [his/her] estate?

1. YES	5. NO	8. DK	9. RF
GO TO T169		GO TO T169	

T908_4

Was it more than 10 percent of [his/her] estate?

1. YES	5. NO	8. DK	9. RF
--------	-------	-------	-------

***END OF **BLOCK_4**: AMOUNT TO CHARITIES (T902_4 - T908_4)

T169

IF R HAD {A TRUST and/or A WILL} ({T155 and T156}=1 or T155=1 or T156=1):
(Excluding any life insurance,) did [he/she] make provisions in [either the trust or the will/the trust/the will] for any of [his/her] brothers or sisters??

OTHERWISE:
(Excluding any life insurance,) were any of [his/her] (possessions) left to any of [his/her] brothers or sisters??

1. YES	5. NO	8. DK	9. RF
GO TO T170			

***BEGINNING OF **BLOCK_5: AMOUNT TO SIBLINGS**
(T902_5 - T908_5)

T902_5

Altogether, how much did [his/her] brothers and sisters receive from [his/her] estate?

[IWER: ACCEPT EITHER A DOLLAR AMOUNT OR A PERCENTAGE]

[IWER: DO NOT PROBE DK/RF]

	OR		<input type="button" value="DK"/>	<input type="button" value="RF"/>
T902_5 AMOUNT		T903_5 PERCENT		
GO TO T170				

T904_5

Was it more than half of [his/her] estate?

1. YES	5. NO	8. DK	9. RF
	GO TO T907_5		GO TO T170

T905_5

Was it more than 75 percent of [his/her] estate?

1. YES	5. NO	8. DK	9. RF
GO TO T170			

T906_5

Was it more than 90 percent of [his/her] estate?

1. YES	5. NO	8. DK	9. RF
GO TO T170			

T907_5

Was it more than 25 percent of [his/her] estate?

1. YES	5. NO	8. DK	9. RF
GO TO T170		GO TO T170	

T908_5

Was it more than 10 percent of [his/her] estate?

1. YES	5. NO	8. DK	9. RF
--------	-------	-------	-------

***END OF BLOCK_5: AMOUNT TO SIBLINGS (T902_5 - T908_5)

T170

IF R HAD {A TRUST and/or A WILL} ({T155 and T156}=1 or T155=1 or T156=1):
 (Excluding any life insurance,) did [he/she] make provisions in [either the trust or the will/the trust/the will] for any other of [his/her] relatives?

OTHERWISE:

Excluding any life insurance,) were any of [his/her] (possessions) left to any other of [his/her] relatives?

1. YES	5. NO	8. DK	9. RF
GO TO T171			

***BEGINNING OF BLOCK_6: AMOUNT TO OTHER RELATIVES

(T902_6 - T908_6)

T902_6

Altogether, how much did these other relatives receive from [his/her] estate?

[IWER: ACCEPT EITHER A DOLLAR AMOUNT OR A PERCENTAGE]

[IWER: DO NOT PROBE DK/RF]

_____	OR	_____	DK	RF
T902_6		T903_6		
AMOUNT		PERCENT		
GO TO T171				

T904_6

Was it more than half of [his/her] estate?

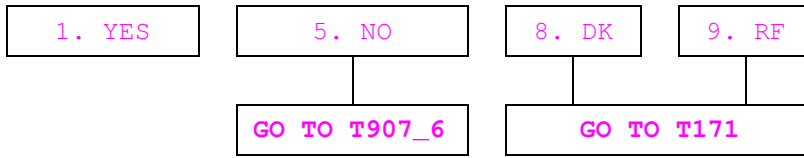

T905_6

Was it more than 75 percent of [his/her] estate?

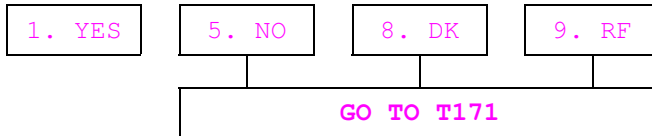

T906_6

Was it more than 90 percent of [his/her] estate?

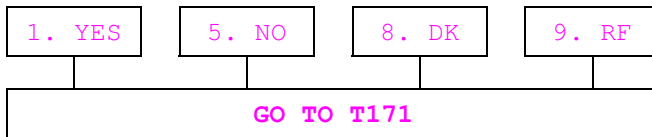

T907_6

Was it more than 25 percent of [his/her] estate?

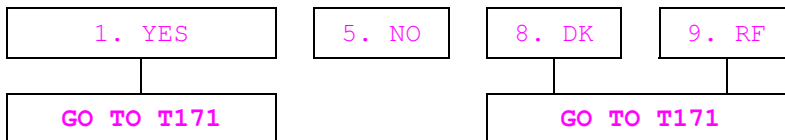

T908_6

Was it more than 10 percent of [his/her] estate?



***END OF **BLOCK_6**: AMOUNT TO OTHER RELATIVES (T902_6 - T908_6)

T171

IF R HAD {A TRUST and/or A WILL} ({T155 and T156}=1 or T155=1 or T156=1):
(Excluding any life insurance,) did [he/she] make provisions in [either the trust or the will/the trust/the will] for any of [his/her] friends?

OTHERWISE:

Excluding any life insurance,) were any of [his/her] (possessions) left to any of [his/her] friends?

1. YES	5. NO	8. DK	9. RF
GO TO T172			

***BEGINNING OF BLOCK 7: AMOUNT TO FRIENDS
(T902_7 - T908_7)

T902_7

Altogether, how much did [his/her] friends receive from [his/her] estate?

[IWER: ACCEPT EITHER A DOLLAR AMOUNT OR A PERCENTAGE]

[IWER: DO NOT PROBE DK/RF]

_____ OR _____

T902_7 T903_7

AMOUNT PERCENT

DK	RF
----	----

GO TO T172

T904_7

Was it more than half of [his/her] estate?

1. YES	5. NO	8. DK	9. RF
	GO TO T907_7	GO TO T172	

T905_7

Was it more than 75 percent of [his/her] estate?

1. YES	5. NO	8. DK	9. RF
GO TO T172			

T906_7

Was it more than 90 percent of [his/her] estate?

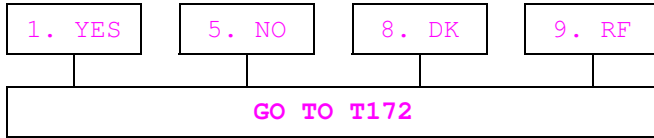

T907_7

Was it more than 25 percent of [his/her] estate?

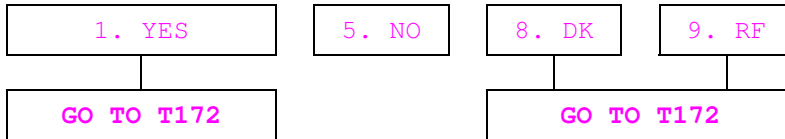

T908_7

Was it more than 10 percent of [his/her] estate?



***END OF **BLOCK_7**: AMOUNT TO FRIENDS (T902_7 - T908_7)

T172

IF R HAD {A TRUST and/or A WILL} ({T155 and T156}=1 or T155=1 or T156=1):
(Excluding any life insurance,) did [he/she] make provisions in [either the trust or the will/the trust/the will] for anyone else or anything else that we have not yet listed?

OTHERWISE:

Excluding any life insurance,) were any of [his/her] (possessions) left to anyone else or anything else that we have not yet listed?

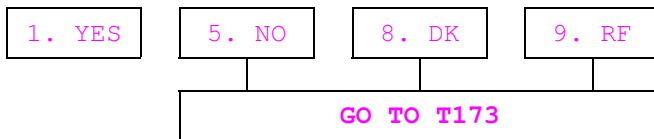

***BEGINNING OF **BLOCK_8: AMOUNT TO OTHERS**
(T902_8 - T908_8)

T902_8

Altogether, how much did those others receive from [his/her] estate?

[IWER: ACCEPT EITHER A DOLLAR AMOUNT OR A PERCENTAGE]

[IWER: DO NOT PROBE DK/RF]

_____	OR	_____	<input type="button" value="DK"/>	<input type="button" value="RF"/>
T902_8 AMOUNT		T903_8 PERCENT		
<input type="button" value="GO TO T173"/>				

T904_8

Was it more than half of [his/her] estate?

<input type="button" value="1. YES"/>	<input type="button" value="5. NO"/>	<input type="button" value="8. DK"/>	<input type="button" value="9. RF"/>
	<input type="button" value="GO TO T907_8"/>		<input type="button" value="GO TO T173"/>

T905_8

Was it more than 75 percent of [his/her] estate?

<input type="button" value="1. YES"/>	<input type="button" value="5. NO"/>	<input type="button" value="8. DK"/>	<input type="button" value="9. RF"/>
<input type="button" value="GO TO T173"/>			

T906_8

Was it more than 90 percent of [his/her] estate?

<input type="button" value="1. YES"/>	<input type="button" value="5. NO"/>	<input type="button" value="8. DK"/>	<input type="button" value="9. RF"/>
<input type="button" value="GO TO T173"/>			

T907_8

Was it more than 25 percent of [his/her] estate?

1. YES	5. NO	8. DK	9. RF
GO TO T173		GO TO T173	

T908_8

Was it more than 10 percent of [his/her] estate?

1. YES	5. NO	8. DK	9. RF
--------	-------	-------	-------

***END OF **BLOCK_8: AMOUNT TO OTHERS** (T902_8 - T908_8)

***END OF T163 ESTATE DISPERSAL LOOP. CONTINUE ON TO T173.

!! EXIT VALUE OF ESTATE

T173

Excluding any life insurance, altogether what was the value of [his/her] total estate?

[IWER: DO NOT PROBE DK/RF]

	DK	RF
AMOUNT		
GO TO T242 BRANCHPOINT		

T174-T176 Unfolding Sequence

Question text: Did it amount to a total of less than \$____ , more than \$____ , or what?

PROCEDURES: 3Up1Down, 2Up2Down, 1Up3Down
BREAKPOINTS: \$10,000, **\$25,000**, **\$100,000**, **\$500,000**, \$2,000,000
RANDOM ENTRY POINTS: \$25,000, \$100,000, \$500,000
ENTRY POINT ASSIGNMENT [1 (\$100,000)] or [2 (\$25,000)] or
[{NOT 1 and NOT 2} (\$500,000)] AT X511

T242 BRANCHPOINT: IF THIS IS A POST-EXIT INTERVIEW (Z145={2 or 3 or 4}) and PROXY DID NOT SAY R STILL OWNED HOME AT TIME OF DEATH (T101 NOT 1), GO TO END OF INTERVIEW

IF THIS IS NOT A POST-EXIT IW (Z145 {NOT 2 and NOT 3 and NOT 4})) and R DID NOT OWN RESIDENCE/MOBILE HOME/FARM IN HH's LAST IW (X079 NOT 1), GO TO T177

T242 (Tag#=T176.5)
Does that include the value of the home?

1. YES	5. NO	8. DK	9. RF
--------	-------	-------	-------

T177 BRANCHPOINT: IF THIS IS A POST-EXIT INTERVIEW (Z145={2 or 3 or 4}), GO TO END OF INTERVIEW

!! EXIT ESTATE IN TRUST

T177

IF R PUT ASSETS INTO TRUST (T155=1):
Is any part of [his/her] estate still held in any type of a trust?

OTHERWISE:

Was any part of [his/her] estate put into a trust after [he/she] died?

1. YES	5. NO	8. DK	9. RF
GO TO T181 BRANCHPOINT			

T178

Who is currently the trustee of this trust?

[IWER: CHOOSE ALL THAT APPLY]

DEFINITION: A TRUSTEE IS A PERSON WHO ADMINISTERS OR MANAGES THE TRUST.

1. SPOUSE/PARTNER	2. CHILD/ CHILD-IN-LAW	3. OTHER RELATIVE	4. ATTORNEY	
5. BANK OFFICER/TRUST DEPARTMENT AT A BANK	6. GRANDCHILD	7. OTHER (SPECIFY) _____ T179	8. DK	9. RF

T180 BRANCHPOINT: IF PROXY DID NOT REPORT THAT TRUSTEE IS A CHILD/GRANDCHILD (T178 {NOT 2 and NOT 6}), GO TO T181 BRANCHPOINT

T180/T065_T180

(Which child is that?)

[IWER: CHOOSE ALL THAT APPLY]

IF GRANDCHILD:

Which child of R's FIRST NAME or [you/[his/her]
[husband/wife/partner]] is the parent of that grandchild?

CHILD NAME(S) [DISPLAYED BY BLAISE FROM PREVIOUS RESPONSES]
3. THROUGH 42. CHILD NAME(S) [ROWS PROVIDED BY BLAISE AS NECESSARY]
92. DECEASED CHILD
97. OTHER (SPECIFY) [T238]
98. DK
99. RF

NOTE: NAMES OF ALL LIVING AND DEAD CHILDREN ARE DISPLAYED. NAMES OF SPOUSE/PARTNERS OF CHILDREN ARE NOT DISPLAYED.

T181 BRANCHPOINT: IF THIS IS A POST-EXIT INTERVIEW (Z145={2 or 3 or 4}), GO TO END OF SECTION T

!! EXIT LIFE INSURANCE SETTLEMENT

T181

IF R HAD {A TRUST or A WILL} (T155=1 or T156=1) or THE WILL HAS BEEN PROBATED (T157=1) or {ASSETS AND POSSESSIONS} WERE DIVIDED AMONG THE HEIRS (T161=1):

In addition to what you have just told me about [his/her] estate did anyone receive a settlement from life insurance?

OTHERWISE:

Did anyone receive a settlement from life insurance?

1. YES	5. NO	8. DK	9. RF
GO TO T190			

T182

Who were the beneficiaries of that life insurance?

[IWER: CHOOSE ALL THAT APPLY]

1. SPOUSE/PARTNER	2. CHILD(REN)	3. GRANDCHILD(REN) OR GREAT-GRANDCHILD(REN)	
4. OTHER RELATIVE(S)	7. OTHER (SPECIFY) T183	8. DK	9. RF

T184 BRANCHPOINT: IF PROXY {DID NOT REPORT THAT BENEFICIARY IS CHILD(REN) *and* DID NOT REPORT THAT IS GRANDCHILD(REN)} (T182 {NOT 2 *and* NOT 3}), GO TO T902_11 BRANCHPOINT

IF R HAS ONLY ONE CHILD (A101=1), GO TO BEGINNING OF T902_10 LOOP

T184

Did each of [his/her] children and their families receive the same amount from life insurance?

1. YES	5. NO	8. DK	9. RF
--------	-------	-------	-------

***BEGINNING OF T902_9 LOOP: LIFE INSURANCE DISPERSAL

T902_9 THROUGH T908_13 ARE ASKED ABOUT ALL CHILD BENEFICIARIES OF R'S LIFE INSURANCE COMBINED.

T902_9 BRANCHPOINT: IF PROXY REPORTED THAT CHILDREN RECEIVED SAME AMOUNT (T184=1) and R HAS MORE THAN ONE CHILD (A101>1), GO TO BEGINNING OF T902_10 LOOP

***BEGINNING OF BLOCK 9: LIFE INSURANCE: SAME AMOUNT TO ALL CHILDREN (T902_9 - T908_9)

T902_9

Altogether, how much did [his/her] children receive from [his/her] life insurance?

[IWER: ACCEPT EITHER A DOLLAR AMOUNT OR A PERCENTAGE]

[IWER: DO NOT PROBE DK/RF]

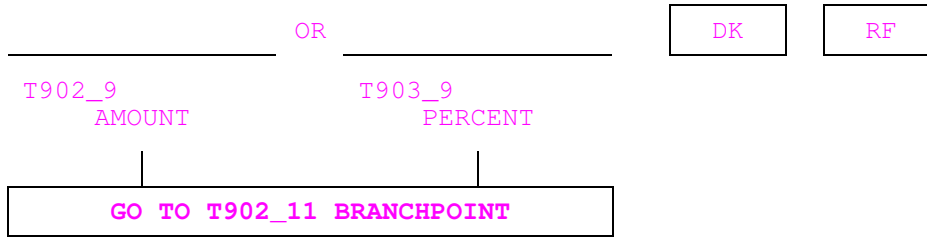

T904_9

Was it more than half of [his/her] life insurance settlement?

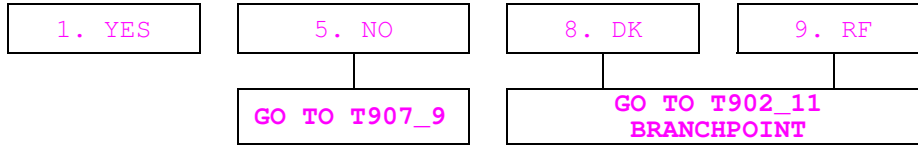

T905_9

Was it more than 75 percent of [his/her] life insurance settlement?

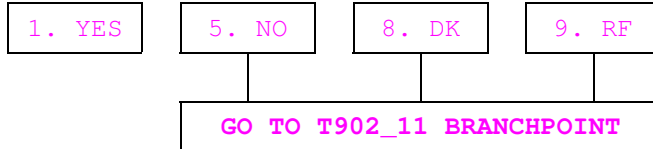

T906_9

Was it more than 90 percent of [his/her] life insurance settlement?

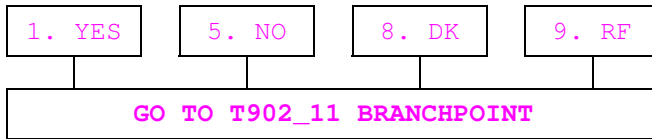

T907_9

Was it more than 25 percent of [his/her] life insurance settlement?

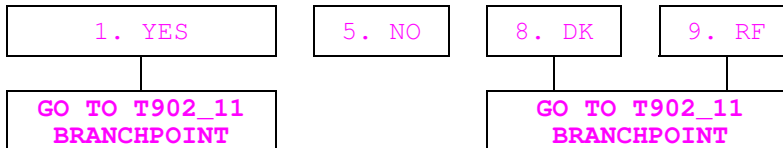

T908_9

Was it more than 10 percent of [his/her] life insurance settlement?

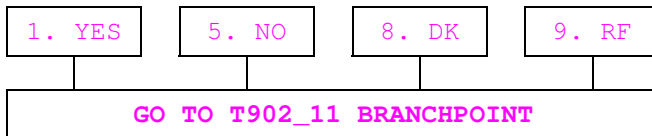

***END OF **BLOCK_9: LIFE INSURANCE:** SAME AMOUNT TO ALL CHILDREN
(T902_9 - T908_9)

T902_10 LOOP BRANCHPOINT: GO TO T902_11 BRANCHPOINT

*** BEGINNING OF T902_10 LOOP: LIFE INSURANCE TO EACH CHILD
T902_10 THROUGH T908_10 ARE ASKED FOR EACH CHILD.

***BEGINNING OF BLOCK_10: LIFE INSURANCE: AMOUNT TO EACH CHILD
(T902_10 - T908_10)

NOTE: THIS BLOCK IS REPEATED FOR EACH CHILD LISTED FOR A HOUSEHOLD.

T902_10

How much did CHILDn NAME and (his/her) family receive from life insurance?

[IWER: ACCEPT EITHER A DOLLAR AMOUNT OR A PERCENTAGE]

[IWER: DO NOT PROBE DK/RF]

_____ OR _____

T902_10 T903_10
AMOUNT PERCENT

DK RF

GO TO END OF T902_10 LOOP (AFTER T908_10)

T904_10

Was it more than half of [his/her] life insurance settlement?

1. YES 5. NO 8. DK 9. RF

GO TO T907_10 GO TO END OF T902_10 LOOP (AFTER T908_10)

T905_10

Was it more than 75 percent of [his/her] life insurance settlement?

1. YES 5. NO 8. DK 9. RF

GO TO END OF T902_10 LOOP (AFTER T908_10)

T906_10

Was it more than 90 percent of [his/her] life insurance settlement?

1. YES 5. NO 8. DK 9. RF

GO TO END OF T902_10 LOOP (AFTER T908_10)

T907_10

Was it more than 25 percent of [his/her] life insurance settlement?

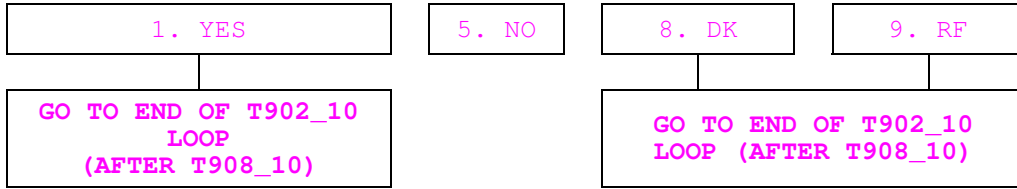

T908_10

Was it more than 10 percent of [his/her] life insurance settlement?

1. YES	5. NO	8. DK	9. RF
--------	-------	-------	-------

***END OF **BLOCK_10: LIFE INSURANCE: AMOUNT TO EACH CHILD**
(T902_10 - T908_10)

***END OF T902_10 LOOP: LIFE INSURANCE TO EACH CHILD
IF THERE ARE NO MORE CHILDREN, CONTINUE ON TO T902_11 BRANCHPOINT. OTHERWISE,
GO BACK TO BEGINNING OF T902_10 LOOP

T902_11 BRANCHPOINT: IF LIFE INSURANCE BENEFICIARY WAS R'S SPOUSE/PARTNER
(T182=1), CONTINUE ON TO T902_11

OTHERWISE, GO TO T902_12 BRANCHPOINT

***BEGINNING OF **BLOCK_11: LIFE INSURANCE: AMOUNT TO SPOUSE/PARTNER**
(T902_11 - T908_11)

T902_11

Altogether, how much did [you/[his/her] [husband/wife/partner]] receive from [his/her] life insurance?

[IWER: ACCEPT EITHER A DOLLAR AMOUNT OR A PERCENTAGE]

[IWER: DO NOT PROBE DK/RF]

	OR		DK	RF
T902_11 AMOUNT		T903_11 PERCENT		

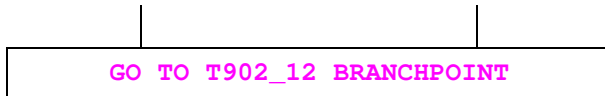

T904_11

Was it more than half of [his/her] life insurance settlement?

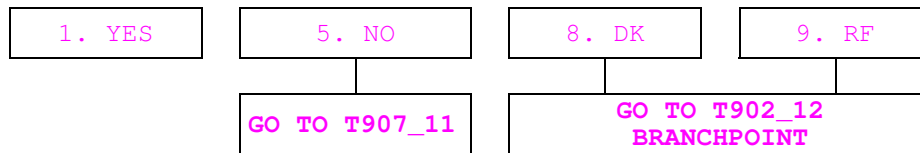

T905_11

Was it more than 75 percent of [his/her] life insurance settlement?

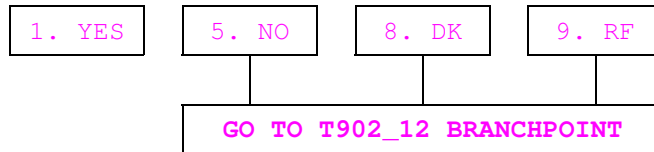

T906_11

Was it more than 90 percent of [his/her] life insurance settlement?

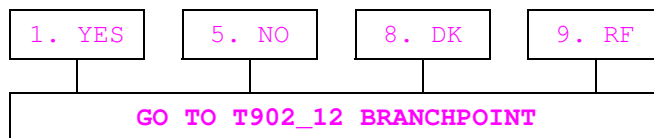

T907_11

Was it more than 25 percent of [his/her] life insurance settlement?

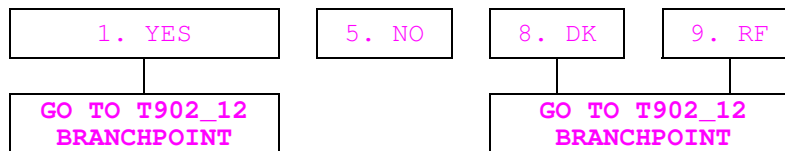

T908_11

Was it more than 10 percent of [his/her] life insurance settlement?



***END OF **BLOCK_11**: LIFE INSURANCE: AMOUNT TO SPOUSE/PARTNER
(T902_11 - T908_11)

T902_12 BRANCHPOINT: IF R's LIFE INSURANCE BENEFICIARY WAS OTHER RELATIVE(S)
(T182=4)}, CONTINUE ON TO T902_12
OTHERWISE, GO TO T902_13 BRANCHPOINT

***BEGINNING OF **BLOCK_12: LIFE INSURANCE: AMOUNT TO OTHER RELATIVES**
(T902_12 - T908_12)

T902_12

Altogether, how much did [his/her] other relatives receive from [his/her] life insurance?

[IWER: ACCEPT EITHER A DOLLAR AMOUNT OR A PERCENTAGE]

[IWER: DO NOT PROBE DK/RF]

_____ OR _____

T902_12 AMOUNT T903_12 PERCENT

| |

| |

| |

GO TO T902_13 BRANCHPOINT

T904_12

Was it more than half of [his/her] life insurance settlement?

1. YES

5. NO

8. DK

9. RF

| | |

| | |

GO TO T907_12

GO TO T902_13
BRANCHPOINT

T905_12

Was it more than 75 percent of [his/her] life insurance settlement?

1. YES

5. NO

8. DK

9. RF

| | | |

GO TO T902_13 BRANCHPOINT

T906_12

Was it more than 90 percent of [his/her] life insurance settlement?

1. YES

5. NO

8. DK

9. RF

| | | |

GO TO T902_13

T907_12

Was it more than 25 percent of [his/her] life insurance settlement?

1. YES	5. NO	8. DK	9. RF
GO TO T902_13 BRANCHPOINT		GO TO T902_13 BRANCHPOINT	

T908_12

Was it more than 10 percent of [his/her] life insurance settlement?

1. YES	5. NO	8. DK	9. RF
--------	-------	-------	-------

***END OF **BLOCK_12: LIFE INSURANCE: AMOUNT TO OTHER RELATIVES**
(T902_12 - T908_12)

T902_13 BRANCHPOINT: IF RESPONSE TO LIFE INSURANCE BENEFICIARY WAS OTHER
(SPECIFY) (T182=7)}, CONTINUE ON TO T902_13

OTHERWISE, GO TO T186 BRANCHPOINT

***BEGINNING OF **BLOCK_13: LIFE INSURANCE: AMOUNT TO NON-RELATIVES**
(T902_13 - T908_13)

T902_13

Altogether, how much did other non-relatives receive from [his/her] life insurance?

[IWER: ACCEPT EITHER A DOLLAR AMOUNT OR A PERCENTAGE]

[IWER: DO NOT PROBE DK/RF]

_____	OR	_____	<input type="checkbox"/> DK	<input type="checkbox"/> RF
T902_13 AMOUNT		T903_13 PERCENT		
GO TO T186 BRANCHPOINT				

T904_13

Was it more than half of [his/her] life insurance settlement?

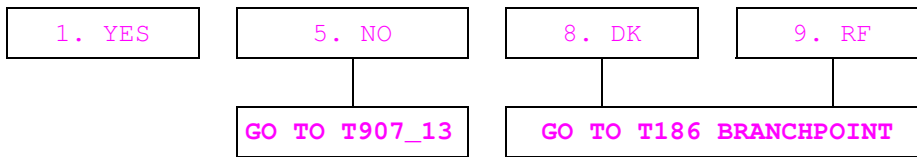

T905_13

Was it more than 75 percent of [his/her] life insurance settlement?



T906_13

Was it more than 90 percent of [his/her] life insurance settlement?

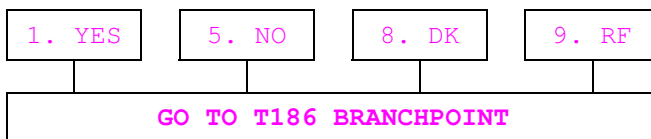

T907_13

Was it more than 25 percent of [his/her] life insurance settlement?

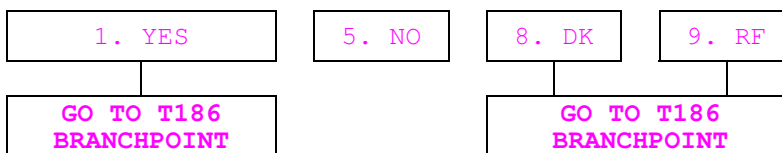

T908_13

Was it more than 10 percent of [his/her] life insurance settlement?



***END OF **BLOCK_13: LIFE INSURANCE:** AMOUNT TO NON-RELATIVES
(T902_13 - T908_13)

***END OF T902_9 LOOP: LIFE INSURANCE DISPERSAL.
CONTINUE ON TO T186.

T186 BRANCHPOINT: IF R's SPOUSE/PARTNER WAS SOLE LIFE INSURANCE BENEFICIARY
(T182=1 ONLY) and A DOLLAR AMOUNT WAS GIVEN (T902_11 ≥ 0),
GO TO T190

T186

Altogether, what was the value of the life insurance settlement?

[IWER: DO NOT PROBE DK/RF]

AMOUNT

DK

RF

GO TO T190

T187-T189 Unfolding Sequence

Question text: Did it amount to a total of less than \$____ , more than \$____ , or what?

PROCEDURES: 3Up1Down, 2Up2Down, 1Up3Down
 BREAKPOINTS: \$10,000, **\$25,000**, **\$100,000**, **\$500,000**, \$2,000,000
 RANDOM ENTRY POINTS: \$25,000, \$100,000, \$500,000
 ENTRY POINT ASSIGNMENT: [1 (\$100,000)] or [2 (\$25,000)] or
 [{NOT 1 and NOT 2} (\$500,000)] AT X512
 ORDER OF ENTRY POINT ASSIGNMENTS AND PROCEDURES CORRESPOND

!! EXIT HEALTH CARE DECISIONS

T190

Now we wish to ask some questions about healthcare decisions toward the end of *R's FIRST NAME's* life.

Did *R's FIRST NAME* provide written instructions about the treatment or care [he/she] wanted to receive during the final days of [his/her] life?

1. YES

5. NO

8. DK

9. RF

GO TO T206

T191

About when were these written instructions dated (approximately)?

T191

MONTH:

01. JAN	02. FEB	03. MAR	04. APR	05. MAY	06. JUN	07. JUL
08. AUG	09. SEP	10. OCT	11. NOV	12. DEC	98. DK	99. RF

DK

RF

T192

YEAR

T193

	1. YES	5. NO	8. DK	9. RF
T193 Did these instructions express a desire to receive all care possible under any circumstances in order to prolong life?				
T194 Did these instructions express a desire to limit care in certain situations?				
T195 Did these instructions express a desire to have any treatment withheld?				
T196 (Did these instructions express a desire to) keep [him/her] comfortable and pain free but to forego extensive measures to prolong life?				

T197

Were these instructions applicable to the actual situation?

1. YES	5. NO	8. DK	9. RF
GO TO T206			

!! EXIT WHO CONSULTED ON HEALTH CARE DECISIONS

T198

Were you consulted about whether these instructions should be followed?

1. YES	5. NO	8. DK	9. RF
--------	-------	-------	-------

T199

Were any (other) family members or other persons consulted?

1. YES	5. NO	8. DK	9. RF
--------	-------	-------	-------

GO TO T204

T200

Who was this?

[IWER: CHOOSE ALL THAT APPLY]

Anyone else?

1. DECEASED R	2. NON-SPOUSE/PARTNER PROXY RESPONDENT	3. SPOUSE/ PARTNER	4. CHILD/CHILD-IN-LAW/ GRANDCHILD
5. OTHER RELATIVE	6. FRIEND	7. PHYSICIAN/HEALTHCARE PROFESSIONAL	8. MINISTER/RABBI/PRIEST/ RELIGIOUS ADVISOR
9. ATTORNEY	10. SOCIAL WORKER	97. OTHER (SPECIFY) _____	98. DK
		T201	99. RF

T202 BRANCHPOINT: IF PROXY DID NOT REPORT THAT A CHILD/GRANDCHILD WAS CONSULTED (T200 NOT 4), GO TO T204

T202/T060_T202

(Which child was that?)

IF GRANDCHILD:

(Which of [his/her] children is the parent of that grandchild?)

[IWER: CHOOSE ALL THAT APPLY]

CHILD NAME(S) [DISPLAYED BY BLAISE FROM PREVIOUS RESPONSES]
3. THROUGH 42. CHILD NAME(S) [ROWS PROVIDED BY BLAISE AS NECESSARY]
92. DECEASED CHILD
93. ALL CHILDREN
97. OTHER (SPECIFY) [T203]
98. DK
99. RF

NOTE: NAMES OF ALL LIVING AND DEAD CHILDREN ARE DISPLAYED. NAMES OF SPOUSE/PARTNERS OF CHILDREN ARE NOT DISPLAYED.

T204

Did any problems come up in trying to follow these written instructions?

1. YES	5. NO	8. DK	9. RF
GO TO T206			

T205

Did the physician or any other health care worker have problems following the written instructions?

1. YES	5. NO	8. DK	9. RF
--------	-------	-------	-------

T206

Did R's FIRST NAME (also) make any legal arrangements for a specific person or persons to make decisions about [his/her] care or medical treatment if [he/she] could not make those decisions [himself/herself]? This is sometimes called a Durable Power of Attorney for Health Care.

1. YES	5. NO	8. DK	9. RF
GO TO T213			

T207

Who had that authority?

[IWER: CHOOSE ALL THAT APPLY]

1. DECEASED R	2. NON-SPOUSE/PARTNER PROXY RESPONDENT	3. SPOUSE/ PARTNER	4. CHILD/CHILD-IN-LAW/ GRANDCHILD
5. OTHER RELATIVE	6. FRIEND	7. PHYSICIAN/HEALTHCARE PROFESSIONAL	8. MINISTER/RABBI/PRIEST/ RELIGIOUS ADVISOR
9. ATTORNEY	10. SOCIAL WORKER	97. OTHER (SPECIFY) _____	98. DK
		T208	99. RF

T209 BRANCHPOINT: IF PROXY DID NOT REPORT THAT A CHILD/GRANDCHILD WAS CONSULTED (T207 NOT 4), GO TO T211

T209/T061_T209

(Which child was that?)

IF GRANDCHILD:

(Which child of R's FIRST NAME (or [you/[his/her] [husband/wife/partner]]) is the parent of that grandchild?)

[IWER: CHOOSE ALL THAT APPLY]

CHILD NAME(S) [DISPLAYED BY BLAISE FROM PREVIOUS RESPONSES]
3. THROUGH 42. CHILD NAME(S) [ROWS PROVIDED BY BLAISE AS NECESSARY]
92. DECEASED CHILD
93. ALL CHILDREN
97. OTHER (SPECIFY) [T210]
98. DK
99. RF

NOTE: NAMES OF ALL LIVING AND DEAD CHILDREN ARE DISPLAYED. NAMES OF SPOUSE/PARTNERS OF CHILDREN ARE NOT DISPLAYED.

T211

When was the Durable Power of Attorney for Health Care made (approximately)?

T211

MONTH:

01. JAN	02. FEB	03. MAR	04. APR	05. MAY	06. JUN	07. JUL
08. AUG	09. SEP	10. OCT	11. NOV	12. DEC	98. DK	99. RF

DK	RF
----	----

T212

YEAR

T213

Did *R's FIRST NAME* ever discuss with you or anyone else the treatment or care [he/she] wanted to receive in the final days of [his/her] life?

1. YES	5. NO	8. DK	9. RF
GO TO T218			

T214

Who was that?

[IWER: CHOOSE ALL THAT APPLY]

2. NON-SPOUSE/PARTNER PROXY RESPONDENT	3. SPOUSE/PARTNER	4. CHILD/CHILD-IN-LAW/ GRANDCHILD		
5. OTHER RELATIVE	6. FRIEND	7. PHYSICIAN/HEALTHCARE PROFESSIONAL	8. MINISTER/RABBI/PRIEST/ RELIGIOUS ADVISOR	
9. ATTORNEY	10. SOCIAL WORKER	97. OTHER (SPECIFY) _____ T215	98. DK	99. RF

T216 BRANCHPOINT: IF PROXY DID NOT REPORT THAT A CHILD/GRANDCHILD WAS CONSULTED (T214 NOT 4), GO TO T218

T216/T062_T216

(Which child was that?)

IF GRANDCHILD:

(Which of [his/her] children is the parent of that grandchild?)

[IWER: CHOOSE ALL THAT APPLY]

CHILD NAME(S) [DISPLAYED BY BLAISE FROM PREVIOUS RESPONSES]
3. THROUGH 42. CHILD NAME(S) [ROWS PROVIDED BY BLAISE AS NECESSARY]
92. DECEASED CHILD
93. ALL CHILDREN
97. OTHER (SPECIFY) [T217]
98. DK
99. RF

NOTE: NAMES OF ALL LIVING AND DEAD CHILDREN ARE DISPLAYED. NAMES OF SPOUSE/PARTNERS OF CHILDREN ARE NOT DISPLAYED.

T218

Did any decisions have to be made about the care and treatment of R's FIRST NAME during the final days of [his/her] life?

1. YES	5. NO	8. DK	9. RF
GO TO T237			

T219

Who was actually involved in making decisions about the care and treatment of R's FIRST NAME during the final days of [his/her] life?

(Who else participated?)

[IWER: CHOOSE ALL THAT APPLY]

1. DECEASED R	2. NON-SPOUSE/PARTNER PROXY RESPONDENT	3. SPOUSE/ PARTNER	4. CHILD/CHILD-IN-LAW/ GRANDCHILD
5. OTHER RELATIVE	6. FRIEND	7. PHYSICIAN/HEALTHCARE PROFESSIONAL	8. MINISTER/RABBI/PRIEST/ RELIGIOUS ADVISOR
9. ATTORNEY	10. SOCIAL WORKER	97. OTHER (SPECIFY) _____	98. DK
		T220	99. RF

T221 BRANCHPOINT: IF PROXY DID NOT REPORT THAT A CHILD/GRANDCHILD WAS CONSULTED (T219 NOT 4), GO TO T223 BRANCHPOINT

T221/T063_T221

(Which child was that?)

IF GRANDCHILD:

(Which of [his/her] children is the parent of that grandchild?)

[IWER: CHOOSE ALL THAT APPLY]

CHILD NAME(S) [DISPLAYED BY BLAISE FROM PREVIOUS RESPONSES]
3. THROUGH 42. CHILD NAME(S) [ROWS PROVIDED BY BLAISE AS NECESSARY]
92. DECEASED CHILD
93. ALL CHILDREN
97. OTHER (SPECIFY) [T222]
98. DK
99. RF

NOTE: NAMES OF ALL LIVING AND DEAD CHILDREN ARE DISPLAYED. NAMES OF SPOUSE/PARTNERS OF CHILDREN ARE NOT DISPLAYED.

T223 BRANCHPOINT: IF DECEASED R WAS AMONG THOSE CONSULTED (T219=1), GO TO T227 BRANCHPOINT

T223

Was R's FIRST NAME able to participate in decisions about [his/her] medical care during the final days of [his/her] life?

1. YES	5. NO	8. DK	9. RF
GO TO T227 BRANCHPOINT		GO TO T227 BRANCHPOINT	

T224

For about how long before R's FIRST NAME died was [he/she] unable to participate in decisions about [his/her] medical care?

_____	OR	_____	OR	_____	DK	RF
T224 MONTHS		T225 DAYS		T226 YEAR		

T227 BRANCHPOINT: IF AT LEAST TWO {PEOPLE OR CATEGORY OF PERSON} PARTICIPATED IN THE DECISIONS ({BETWEEN QUESTIONS T219 AND T221} AND T223=1) see NOTE, below), CONTINUE ON TO T227

OTHERWISE, GO TO T230

NOTE: "AT LEAST TWO {PEOPLE OR CATEGORY OF PERSONS}" CAN BE

- (a) NUMBER OF SELECTIONS AT {T219 or T221} > 1, or
- (b) SELECTION OF {"1. DECEASED R(AT T219 or T223=1} IN ADDITION TO ONE OTHER SELECTION AT T219, or
- (c) MORE THAN ONE CHILD SELECTED AT T221, WHICH CAN INCLUDE (92. DECEASED CHILD(, or
- (d) SELECTION OF (93. ALL CHILDREN(AT T221.

T227

Who was the main decision-maker?

1. DECEASED R	2. NON-SPOUSE/PARTNER PROXY RESPONDENT	3. SPOUSE/ PARTNER	4. CHILD/CHILD-IN-LAW/ GRANDCHILD
5. OTHER RELATIVE	6. FRIEND	7. PHYSICIAN/HEALTHCARE PROFESSIONAL	8. MINISTER/RABBI/PRIEST/ RELIGIOUS ADVISOR
9. ATTORNEY	10. SOCIAL WORKER	97. OTHER (SPECIFY) _____ T244	98. DK
			99. RF

NOTE: RESPONSE "1. DECEASED R" APPEARS ONLY IF PROXY SAID R WAS ABLE TO PARTICIPATE IN HIS/HER OWN DECISIONS (T223=1).

T228 BRANCHPOINT: IF PROXY DID NOT REPORT THAT A CHILD/GRANDCHILD WAS CONSULTED (T227 NOT 4), GO TO T230

IF {PROXY GAVE ONLY 1 RESPONSE TO T221 and THAT RESPONSE WAS NOT "ALL CHILDREN" (T221 NOT 93)}, GO TO T230

T228

(Which child was that?)

IF GRANDCHILD:

(Which of [his/her] children is the parent of that grandchild?)

CHILD NAME(S) [DISPLAYED BY BLAISE FROM PREVIOUS RESPONSES]
3. THROUGH 42. CHILD NAME(S) [ROWS PROVIDED BY BLAISE AS NECESSARY]
92. DECEASED CHILD
97. OTHER (SPECIFY) [T229]
98. DK
99. RF

NOTE: NAMES OF ALL LIVING AND DEAD CHILDREN ARE DISPLAYED. NAMES OF SPOUSE/PARTNERS OF CHILDREN ARE NOT DISPLAYED.

!! EXIT TYPE OF HEALTH CARE DECISIONS

T230

Did those last decisions involve a desire to give all care possible unconditionally in order to prolong life?

1. YES	5. NO	8. DK	9. RF
--------	-------	-------	-------

T231

Did those last decisions involve limiting care in certain situations?

1. YES	5. NO	8. DK	9. RF
--------	-------	-------	-------

T232

Did those last decisions involve withholding any treatment?

1. YES	5. NO	8. DK	9. RF
--------	-------	-------	-------

T233

Did those last decisions rest largely on keeping R's FIRST NAME comfortable and pain free without taking extensive measures to prolong life?

1. YES	5. NO	8. DK	9. RF
--------	-------	-------	-------

T234

Did any doctor(s) recommend any care or treatment that the family or other decision-maker(s) ultimately refused?

1. YES	5. NO	8. DK	9. RF
GO TO T236			

T235

Did *R's FIRST NAME* receive this treatment anyway?

1. YES	5. NO	8. DK	9. RF
--------	-------	-------	-------

T236

Did cost enter into the decisions about what care or treatment [he/she] would receive in the final days of [his/her] life?

1. YES	5. NO	8. DK	9. RF
--------	-------	-------	-------

T237

Thinking back over the course of *R's FIRST NAME's* life, what would you say were [his/her] greatest strengths?

	DK	RF

GO TO SECTION U