

NOTE ABOUT BRANCHPOINTS:

WHERE THERE IS MORE THAN ONE JUMP WITHIN A BRANCHPOINT BOX, THE JUMPS ARE TO BE APPLIED IN ORDER FROM THE TOP.

NOTE ABOUT COLORS:

ALL QUESTION TEXT IN BLACK IS FOR THE CORE INTERVIEW.

ALL QUESTION TEXT IN FUCHSIA IS FOR THE EXIT INTERVIEW. ALSO IN FUCHSIA IS ALL OTHER TEXT THAT IS SPECIFIC TO THE EXIT INTERVIEW BUT NOT TO THE CORE.

OTHERWISE, BLACK TEXT FOR CODEFRAMES, INTERVIEWER INSTRUCTIONS, JUMPS AND BRANCHPOINTS, ETC. CAN APPLY TO BOTH THE CORE AND THE EXIT INTERVIEW UNLESS SPECIFIED OTHERWISE OR THERE IS AN EXIT ALTERNATIVE.

ON A BLACK-AND-WHITE HARD COPY OF THE DOCUMENT, THE FUCHSIA TEXT WILL APPEAR SOMEWHAT LIGHTER THAN THE ORIGINAL BLACK.

NOTE ABOUT EXIT INTERVIEW Rs:

ANY NEW SPOUSE/PARTNER THAT AN EXIT INTERVIEW R ACQUIRED SINCE HIS/HER LAST INTERVIEW IS IGNORED FOR THE PURPOSES OF THIS INTERVIEW.

FOR AN EXIT INTERVIEW A "NEW INTERVIEW R" IS A SPOUSE/PARTNER WHO WAS REPORTED IN A PREVIOUS WAVE BUT WHO HAS NEVER BEEN INTERVIEWED.

J323/T001 BRANCHPOINT: IF THIS IS AN EXIT INTERVIEW, GO TO N1x/T101

T001

Q5882

J323. Do you currently have a will that is written and witnessed?

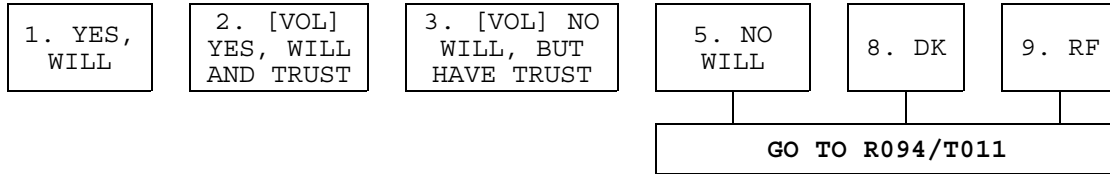

T002

Q5883

J324. Have you made provisions in your [will/will or trust/trust] for any family members other than your [husband/wife/partner]?

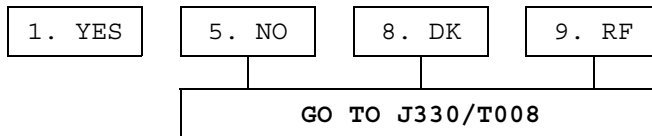

J325/T003 BRANCHPOINT: IF R DOES NOT HAVE CHILDREN OR STEP-CHILDREN (CS49Y16/A101=0), GO TO J329/T006 BRANCHPOINT

T003

Q5884

J325. Does that include any child or step-child?

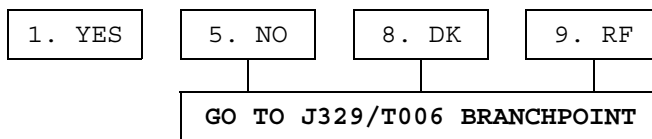

T004 (Tag#=T004.5)
 Q5885
 J326. Which child is that?

[IWER: CHOOSE ALL THAT APPLY. IF ONLY ONE CHILD APPEARS, SELECT AND MOVE ON.]

| |
|--|
| CHILD NAME(S) [DISPLAYED BY BLAISE FROM PREVIOUS RESPONSES] |
| 3. THROUGH 42. CHILD NAME(S) [ROWS PROVIDED BY BLAISE AS NECESSARY] |
| 93. ALL CHILDREN EQUALLY |
| 96. ALL CHILDREN — "EQUALLY" NOT MENTIONED |
| 98. DK |
| 99. RF |

NOTE: NAMES OF ALL LIVING AND DEAD CHILDREN ARE DISPLAYED. NAMES OF SPOUSE/PARTNERS OF CHILDREN ARE NOT DISPLAYED.

J328/T005 BRANCHPOINT: IF R REPORTED THAT MADE PROVISION FOR ALL CHILDREN EQUALLY (J326/T004=93), GO TO J329/T006 BRANCHPOINT

IF IWER MADE ONLY 1 SELECTION AT J326/T004 and IT WAS NOT 96 ('ALL CHILDREN — "EQUALLY" NOT MENTIONED'), GO TO J329/T006 BRANCHPOINT

T005
 Q5886
 J328. Does that document provide for all your children about equally?

| | | | |
|--------|-------|-------|-------|
| 1. YES | 5. NO | 8. DK | 9. RF |
|--------|-------|-------|-------|

J329/T006 BRANCHPOINT: IF R DOES NOT HAVE GRANDCHILDREN (D40/E046={0 or 95 or DK or RF}), GO TO J330/T008

T006
 Q5887
 J329. Does that document include any grandchild directly?

| | | | | |
|-----------------|-------------------------------------|-------|-------|-------|
| 1. YES | 2. [VOL] ONLY THROUGH THEIR PARENTS | 5. NO | 8. DK | 9. RF |
| GO TO J330/T008 | | | | |

T007
Q5888

J329a. Which of your children is the parent of that grandchild?

[IWER: CHOOSE ALL THAT APPLY]

| |
|--|
| CHILD NAME(S) [DISPLAYED BY BLAISE FROM PREVIOUS RESPONSES] |
| 3. THROUGH 42. CHILD NAME(S) [ROWS PROVIDED BY BLAISE AS NECESSARY] |
| 92. DECEASED CHILD |
| 93. ALL CHILDREN EQUALLY |
| 98. DK |
| 99. RF |

NOTE: NAMES OF ALL LIVING AND DEAD CHILDREN ARE DISPLAYED. NAMES OF SPOUSE/PARTNERS OF CHILDREN ARE NOT DISPLAYED.

T008
Q5889

J330. Have you made provisions for any charities in your will or trust?

| | | | |
|--------|-------|-------|-------|
| 1. YES | 5. NO | 8. DK | 9. RF |
|--------|-------|-------|-------|

T011
Q6409

R94. Do you have any life insurance, including individual or group policies?

| | | | |
|-----------------|-------|-------|-------|
| 1. YES | 5. NO | 8. DK | 9. RF |
| GO TO R101/T036 | | | |

T012
Q6419

R95. How many different life insurance policies do you have?

[IWER: INCLUDE INDIVIDUAL POLICIES, GROUP POLICIES, OR PAID-UP POLICIES IF R ASKS]

| | | | | | | |
|--------|--------|----------|---------|-----------------|-------|-------|
| 1. ONE | 2. TWO | 3. THREE | 4. FOUR | 5. FIVE OR MORE | 8. DK | 9. RF |
|--------|--------|----------|---------|-----------------|-------|-------|

T013
Q6421

R97. (Altogether), what is the total face value of [this policy/these policies], that is, the amount of money the beneficiary would get if you were to die?

[IWER: DO NOT PROBE DK/RF]

| | | |
|----------------|----|----|
| | DK | RF |
| AMOUNT | | |
| | | |
| GO TO R98/T017 | | |

T014-T016 Unfolding Sequence

Question text: Does it amount to less than \$____ , more than \$____ , or what?

PROCEDURES: UNFM_3Up, UNFM_2Up1Down, UNFM_1Up2Down
 BREAKPOINTS: \$2,500, \$25,000, \$50,000, \$250000
 RANDOM ENTRY POINTS: \$2,500, \$25,000, \$50,000
 ENTRY POINT ASSIGNMENT 1, 2 OR 3 AT Q129/Z087

T017
Q6428

R98. Who are the beneficiaries of [this policy/all of these policies]?

[IWER: CHOOSE ALL THAT APPLY]

| |
|--|
| CHILD NAME(S) [DISPLAYED BY BLAISE FROM PREVIOUS RESPONSES] |
| 3. THROUGH 42. CHILD NAME(S) [ROWS PROVIDED BY BLAISE AS NECESSARY] |
| 91. SPOUSE/PARTNER |
| 96. ALL CHILDREN |
| 97. OTHER (SPECIFY) [T045] |
| 98. DK |
| 99. RF |

NOTE: NAMES OF ALL LIVING AND DEAD CHILDREN ARE DISPLAYED. NAMES OF SPOUSE/PARTNERS OF CHILDREN ARE NOT DISPLAYED.

T018
Q6429

R99. [Is this a life insurance policy that builds/Are any of these life insurance policies ones that build] up a cash value that you can borrow against, or that you would receive if the policy were to be cancelled?

DEFINITION: THESE ARE SOMETIMES CALLED 'WHOLE LIFE' OR 'STRAIGHT LIFE POLICIES'.

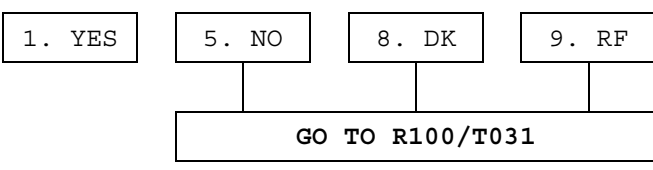

R99a BRANCHPOINT: IF R HAS ONLY ONE LIFE INSURANCE POLICY (R95/T012=1), GO TO R99c/T024

T019
Q6430

R99a. (How many such policies do you have?)

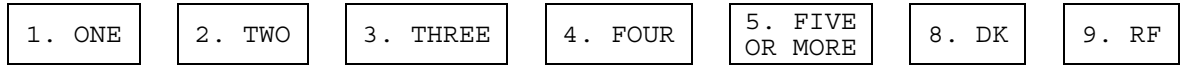

T020
Q6431

R99b. What is the current face value of [these policies/this policy]?

[IWER: DO NOT PROBE DK/RF]

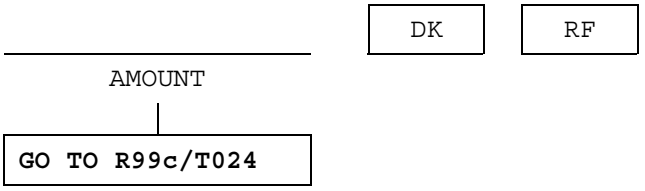

T021-T023 Unfolding Sequence

Question text: Does it amount to less than \$____, more than \$____, or what?

PROCEDURES: UNFM_3Up, UNFM_2Up1Down, UNFM_1Up2Down
 BREAKPOINTS: \$2,500, \$25,000, \$50,000, \$250000
 RANDOM ENTRY POINTS: \$2,500, \$25,000, \$50,000
 ENTRY POINT ASSIGNMENT 1, 2 OR 3 AT Q129/Z087

HRS 2002 — SECTION T: WILLS/LIFE INSURANCE — PAGE 7

FINAL VERSION 4 — 10/02/2006

T024
Q6438

R99c. (Altogether) about how much do you pay for [these policies/this policy] each month or year?

[IWER: ENTER 0 IF PAID UP OR NO PREMIUM PAYMENTS]

| | | | |
|--------|-----------------------------|----|----|
| AMOUNT | 0 NO PREMIUM PAYMENTS | DK | RF |
| | GO TO R99d/T029 BRANCHPOINT | | |

T025
Q6439
R99c1. PER:

| | | | |
|---------|----------|-------|-------|
| 1. YEAR | 2. MONTH | 8. DK | 9. RF |
|---------|----------|-------|-------|

R99d/T029 BRANCHPOINT: IF R HAS ONLY ONE LIFE INSURANCE POLICY (R95/T012=1), GO TO R100/T031

T029
Q6440

R99d. Who are the beneficiaries of [these policies/this policy]?

[IWER: CHOOSE ALL THAT APPLY]

| |
|--|
| CHILD NAME(S) [DISPLAYED BY BLAISE FROM PREVIOUS RESPONSES] |
| 3. THROUGH 42. CHILD NAME(S) [ROWS PROVIDED BY BLAISE AS NECESSARY] |
| 91. R'S SPOUSE/PARTNER |
| 93. ALL CHILDREN |
| 97. OTHER (SPECIFY) [T030] |
| 98. DK |
| 99. RF |

NOTE: NAMES OF ALL LIVING AND DEAD CHILDREN ARE DISPLAYED. NAMES OF SPOUSE/PARTNERS OF CHILDREN ARE NOT DISPLAYED.

T031
Q6441

R100. [Since *FAMILY R's LAST IW MONTH, YEAR*/In the last 2 years] have you obtained any new life insurance policies?

| | | | |
|-----------------|-------|-------|-------|
| 1. YES | 5. NO | 8. DK | 9. RF |
| GO TO R101/T036 | | | |

T032
Q6442

R100a. What is the total face value of (this policy/all of these policies)?

[IWER: DO NOT PROBE DK/RF]

AMOUNT

| | |
|----|----|
| DK | RF |
|----|----|

|

| |
|-----------------|
| GO TO R101/T036 |
|-----------------|

T033-T035 Unfolding Sequence

Question text: Does it amount to less than \$____ , more than \$____ , or what?

PROCEDURE: 2Up1Down

BREAKPOINTS: \$2,500, **\$25,000**, \$50,000, \$250,000

ENTRY POINT: \$25,000

T036
Q6447

R101. [Since *FAMILY R's LAST IW MONTH, YEAR*/In the last 2 years] have you allowed any life insurance policies to lapse or have any been cancelled?

| | | | |
|----------------------------|-------|-------|-------|
| 1. YES | 5. NO | 8. DK | 9. RF |
| GO TO R119/T047 (T ASSIST) | | | |

T037
Q6448

R102. What was the total face value of (this policy/all of these policies)?

[IWER: DO NOT PROBE DK/RF]

AMOUNT

DK

RF

|

GO TO R103/T041

T038-T040 Unfolding Sequence

Question text: Does it amount to less than \$____, more than \$____, or what?

PROCEDURES: UNFM_3Up, UNFM_2Up1Down, UNFM_1Up2Down
 BREAKPOINTS: \$2,500, \$25,000, \$50,000, \$250,000
 RANDOM ENTRY POINTS: \$2,500, \$25,000, \$50,000
 ENTRY POINT ASSIGNMENT 1, 2 OR 3 AT Q129/Z087

T041
Q6455

R103. Was this lapse or cancellation something you chose to do, or was it done by the provider, your employer, or someone else?

1. R'S CHOICE

2. PROVIDER/EMPLOYER/
SOMEONE ELSE CHOSE

8. DK

9. RF

|

GO TO R119/T047
(T ASSIST)

T042
Q6456

R104. Was it because the policy was too expensive, because you did not need the coverage or some other reason?

1. TOO EXPENSIVE

2. COVERAGE NOT NEEDED

7. OTHER (SPECIFY)

T048
(Tag#=T042.5)

8. DK

9. RF

T043
Q6457

R105. Did you receive any cash when the policy was cancelled or allowed to lapse?

1. YES

5. NO

8. DK

9. RF

|

GO TO R119/T047 (T ASSIST)

T044

Q6458

R106. About how much cash did you receive?

AMOUNT

| | |
|----|----|
| DK | RF |
|----|----|

T047

Q6515

R119. T ASSIST

IWER: HOW OFTEN DID R RECEIVE ASSISTANCE WITH ANSWERS IN
SECTION T — WILLS/LIFE INSURANCE?

| | | | |
|----------|----------------|-------------------------------|--|
| 1. NEVER | 2. A FEW TIMES | 3. MOST OR ALL OF THE TIME | 4. THE SECTION WAS DONE BY A PROXY REPORTER |
|----------|----------------|-------------------------------|--|

N1x/T101 BRANCHPOINT: IF THIS IS NOT AN EXIT INTERVIEW, GO TO SECTION U

IF R DID NOT OWN HOME IN HH's LAST IW (PR284/Z132 NOT 1), GO TO N6x/T124 BRANCHPOINT

T101
Q2323X

N1x. IF PROXY IS THE SURVIVING SPOUSE/PARTNER (CS1A/A009=2):
Our records show that you and R's FIRST NAME owned a home in HH's LAST IW 1ST RESIDENCE CITY, STATE in [R's LAST IW MONTH, YEAR/the last two years].

IF R'S SPOUSE/PARTNER IS LIVING (CS5/A023=1) and PROXY IS NOT R'S SPOUSE/PARTNER (CS1A/A009 NOT 2):
Our records show that [he/she] and [his/her] [husband/wife/partner] owned a home in HH's LAST IW 1ST RESIDENCE CITY, STATE in [R's LAST IW MONTH, YEAR/the last two years].

IF R'S SPOUSE/PARTNER IS NOT LIVING (CS5/A023 NOT 1) and PROXY IS NOT R'S SPOUSE/PARTNER (CS1A/A009 NOT 2):
Our records show that R's FIRST NAME owned a home in HH's LAST IW 1ST RESIDENCE CITY, STATE in [R's LAST IW MONTH, YEAR/the last two years].

OTHERWISE:
Our records show that you and [he/she] owned a home in HH's LAST IW 1ST RESIDENCE CITY, STATE in [R's LAST IW MONTH, YEAR/the last two years].

ASK ALL PROXIES:

Please, let me confirm, did R's FIRST NAME still own that home when [he/she] died?

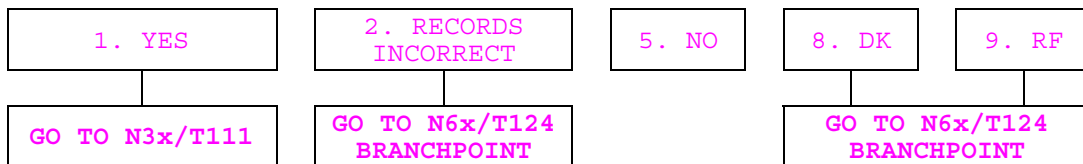

T102
Q2324X

N1ax. What happened to that home — did R's FIRST NAME sell it, give it to someone, or what?

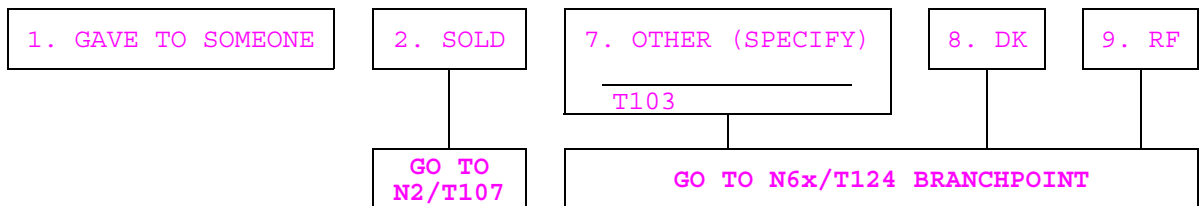

T104
Q2325X

N1bx. To whom did [he/she] give the house, (that is, what was their relationship to R's FIRST NAME)?

[IWER: CHOOSE ALL THAT APPLY]

| | | |
|-----------|----------------------------------|-------------------|
| 1. SPOUSE | 2. CHILD/CHILD-IN-LAW/GRANDCHILD | 3. OTHER RELATIVE |
| 4. FRIEND | 5. CHARITY | 7. SOMEONE ELSE |
| | 8. DK | 9. RF |

N1cx/T105 BRANCHPOINT: IF PROXY DID NOT REPORT THAT R GAVE THE HOUSE TO A CHILD/GRANDCHILD (N1bx/T104 NOT 2), GO TO N2/T107

T105
Q2326X

N1cx. (Which child is that?)

[IWER: CHOOSE ALL THAT APPLY]

IF GRANDCHILD:
Which child of R's FIRST NAME (or [you/[his/her] [husband/wife/partner]]) is the parent of that grandchild?

| |
|--|
| CHILD NAME(S) [DISPLAYED BY BLAISE FROM PREVIOUS RESPONSES] |
| 3. THROUGH 42. CHILD NAME(S) |
| [ROWS PROVIDED BY BLAISE AS NECESSARY] |
| 92. DECEASED CHILD |
| 93. ALL CHILDREN |
| 94. ALL CHILDREN EQUALLY |
| 97. OTHER (SPECIFY) [T106] |
| 98. DK |
| 99. RF |

NOTE: NAMES OF ALL LIVING AND DEAD CHILDREN ARE DISPLAYED. NAMES OF SPOUSE/PARTNERS OF CHILDREN ARE NOT DISPLAYED.

T107
Q2335X

N2. IF R SOLD THE HOME (N1ax/T102=2)
What was the selling price?

OTHERWISE:

What was the value of that house? I mean, what would it have brought if it had been sold?

[IWER: DO NOT PROBE DK/RF]

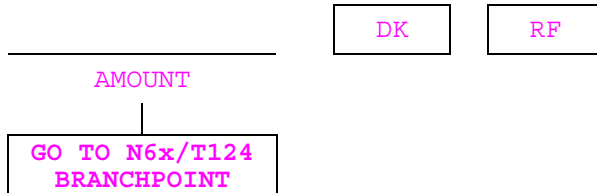

T108-T110 Unfolding Sequence

Question text: Did it amount to a total of less than \$____, more than \$____, or what?

PROCEDURE: 1Up1Down

BREAKPOINTS: \$15,000, \$50,000, \$200,000

ENTRY POINT: \$50,000

N3x/T111 BRANCHPOINT: GO TO N6x/T124 BRANCHPOINT

T111
Q2343X

N3x. What happened to that home after R's FIRST NAME's death:

IF PROXY IS THE SURVIVING SPOUSE/PARTNER (CS1A/A009=2):

Do you own it now, was it sold, was it inherited by someone else, has it not yet been disposed of, or what?

IF R's SPOUSE/PARTNER IS STILL LIVING (CS5/A023=1):

Does [his/her] [husband/wife/partner] own it now, was it sold, was it inherited by someone else, has it not yet been disposed of, or what?

OTHERWISE:

was it sold, was it inherited by someone else, has it not yet been disposed of, or what?

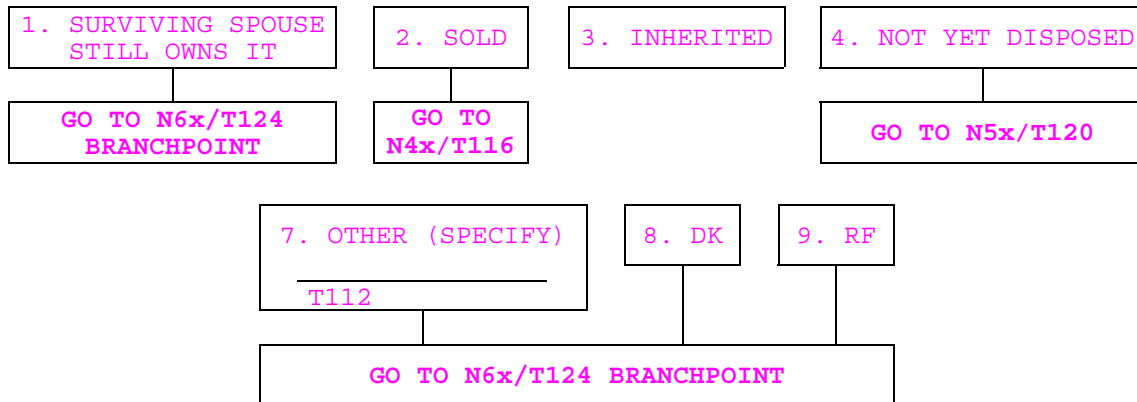

T113
Q2344X

N3ax. Who inherited the house, (that is, what was their relationship to R's FIRST NAME)?

[IWER: CHOOSE ALL THAT APPLY]

| | | |
|-----------|----------------------------------|-------------------|
| 1. SPOUSE | 2. CHILD/CHILD-IN-LAW/GRANDCHILD | 3. OTHER RELATIVE |
| 4. FRIEND | 5. CHARITY | 7. SOMEONE ELSE |
| | | 8. DK |
| | | 9. RF |

N3bx/T114 BRANCHPOINT: IF PROXY DID NOT REPORT THAT CHILD/GRANDCHILD INHERITED THE HOUSE (N3ax/T113 NOT 2), GO TO N4x/T116

T114
Q2345X

N3bx. (Which child is that?)

[IWER: CHOOSE ALL THAT APPLY]

IF GRANDCHILD:
Which child of R's FIRST NAME (or [you/[his/her] [husband/wife/partner]]) is the parent of that grandchild?

| |
|--|
| CHILD NAME(S) [DISPLAYED BY BLAISE FROM PREVIOUS RESPONSES] |
| 3. THROUGH 42. CHILD NAME(S) [ROWS PROVIDED BY BLAISE AS NECESSARY] |
| 92. DECEASED CHILD |
| 93. ALL CHILDREN |
| 94. ALL GRANDCHILDREN EQUALLY |
| 97. OTHER (SPECIFY) [T115] |
| 98. DK |
| 99. RF |

NOTE: NAMES OF ALL LIVING AND DEAD CHILDREN ARE DISPLAYED. NAMES OF SPOUSE/PARTNERS OF CHILDREN ARE NOT DISPLAYED.

T122
Q2354X

N5bx. (Which child is that?)

[IWER: CHOOSE ALL THAT APPLY]

IF GRANDCHILD:

Which child of R's FIRST NAME (or [you/[his/her] [husband/wife/partner]]) is the parent of that grandchild?

| |
|--|
| CHILD NAME(S) [DISPLAYED BY BLAISE FROM PREVIOUS RESPONSES] |
| 3. THROUGH 42. CHILD NAME(S) [ROWS PROVIDED BY BLAISE AS NECESSARY] |
| 92. DECEASED CHILD |
| 93. ALL CHILDREN |
| 94. ALL GRANDCHILDREN EQUALLY |
| 97. OTHER (SPECIFY) [T123] |
| 98. DK |
| 99. RF |

NOTE: NAMES OF ALL LIVING AND DEAD CHILDREN ARE DISPLAYED. NAMES OF SPOUSE/PARTNERS OF CHILDREN ARE NOT DISPLAYED.

N6x/T124 BRANCHPOINT: IF R DID NOT HAVE A SECOND RESIDENCE AT HH'S LAST IW (X028 NOT 1) or IF THIS IS A POST-EXIT INTERVIEW (Z145={2 or 3 or 5}), GO TO N62x/T148

T124
Q2358X

N6x. Our records show that R's FIRST NAME also had a home in HH's LAST IW 2ND RESIDENCE CITY, STATE.

Remind me, did [he/she] own that home when [he/she] died?

| | | | | |
|----------------|----------------------|-------|-----------------|-------|
| 1. YES | 2. RECORDS INCORRECT | 5. NO | 8. DK | 9. RF |
| GO TO N8x/T135 | GO TO N62x/T148 | | GO TO N62x/T148 | |

T125
Q2359X

N6ax. Did R's FIRST NAME ever own it?

| | | | |
|-----------------|-------|-------|-------|
| 1. YES | 5. NO | 8. DK | 9. RF |
| GO TO N62x/T148 | | | |

T126
Q2360X

N6bx. What happened to that home after *R's FIRST NAME's* death: [do you own it now/does [his/her] [husband/wife/partner] own it now], was it sold, was it inherited by someone else, has it not been disposed of, or what?

| | | | | |
|--------------------|------------------|-----------------------------|-------|-------|
| 1. GAVE TO SOMEONE | 2. SOLD | 7. OTHER (SPECIFY) _____ | 8. DK | 9. RF |
| | | T127 | | |
| | GO TO N6/T131 | GO TO N62x/T148 | | |

T128
Q2365X

N6cx. To whom did [he/she] give the house, (that is, what was their relationship to *R's FIRST NAME*)?

[IWER: CHOOSE ALL THAT APPLY]

| | | | |
|------------|--------------------------------------|-------------------|-----------|
| 1. SPOUSE | 2. CHILD/CHILD-IN-LAW/ GRANDCHILD | 3. OTHER RELATIVE | 4. FRIEND |
| 5. CHARITY | 7. SOMEONE ELSE | 8. DK | 9. RF |

N6dx/T129 BRANCHPOINT: IF PROXY DID NOT REPORT THAT CHILD/GRANDCHILD LIVES IN HOUSE (N6cx/T128 NOT 2), GO TO N6/T131

T129
Q2366X

N6dx. (Which child is that?)

[IWER: CHOOSE ALL THAT APPLY]

IF GRANDCHILD:
Which child of *R's FIRST NAME* (or [you/[his/her] [husband/wife/partner]]) is the parent of that grandchild?

| |
|--|
| CHILD NAME(S) [DISPLAYED BY BLAISE FROM PREVIOUS RESPONSES] |
| 3. THROUGH 42. CHILD NAME(S) |
| [ROWS PROVIDED BY BLAISE AS NECESSARY] |
| 92. DECEASED CHILD |
| 93. ALL CHILDREN |
| 94. ALL GRANDCHILDREN EQUALLY |
| 97. OTHER (SPECIFY) [T130] |
| 98. DK |
| 99. RF |

NOTE: NAMES OF ALL LIVING AND DEAD CHILDREN ARE DISPLAYED. NAMES OF SPOUSE/PARTNERS OF CHILDREN ARE NOT DISPLAYED.

T131
Q2375X

N6. IF R SOLD THE HOME (N6bx/T126=2):
What was the selling price?

OTHERWISE:
What was the value of that house? I mean, what would it have brought if
it had been sold?

[IWER: DO NOT PROBE DK/RF]

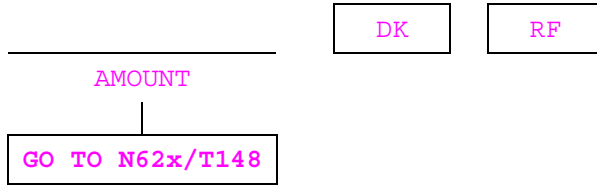

T132-T134 Unfolding Sequence

Question text: Did it amount to a total of less than \$____ , more than
\$____ , or what?

PROCEDURE: 1Up1Down
BREAKPOINTS: \$15,000, \$50,000, \$200,000
ENTRY POINT: \$50,000

N8x/T135 BRANCHPOINT: GO TO N62x/T148

T135
Q2383X

N8x. What happened to that home after R's FIRST NAME's death: was it sold,
was it inherited by someone else, has it not yet been disposed of, or
what?

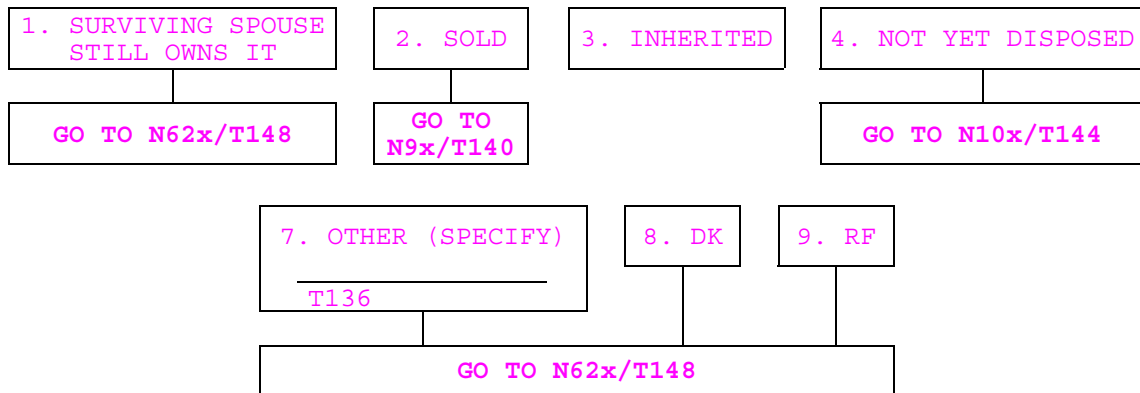

T137
Q2384X

N8ax. Who inherited the house, (that is, what was their relationship to R's FIRST NAME)?

[IWER: CHOOSE ALL THAT APPLY]

| | | | |
|------------|--------------------------------------|-------------------|-----------|
| 1. SPOUSE | 2. CHILD/CHILD-IN-LAW/ GRANDCHILD | 3. OTHER RELATIVE | 4. FRIEND |
| 5. CHARITY | 7. SOMEONE ELSE | 8. DK | 9. RF |

N8bx/T138 BRANCHPOINT: IF PROXY DID NOT REPORT THAT CHILD/GRANDCHILD LIVES IN HOUSE (N8ax/T137 NOT 2), GO TO N9x/T140

T138
Q2385X

N8bx. (Which child is that?)

[IWER: CHOOSE ALL THAT APPLY]

IF GRANDCHILD:
Which child of R's FIRST NAME (or [you/[his/her] [husband/wife/partner]]) is the parent of that grandchild?

| |
|--|
| CHILD NAME(S) [DISPLAYED BY BLAISE FROM PREVIOUS RESPONSES] |
| 3. THROUGH 42. CHILD NAME(S) [ROWS PROVIDED BY BLAISE AS NECESSARY] |
| 92. DECEASED CHILD |
| 93. ALL CHILDREN |
| 94. ALL GRANDCHILDREN EQUALLY |
| 97. OTHER (SPECIFY) [T139] |
| 98. DK |
| 99. RF |

NOTE: NAMES OF ALL LIVING AND DEAD CHILDREN ARE DISPLAYED. NAMES OF SPOUSE/PARTNERS OF CHILDREN ARE NOT DISPLAYED.

T140
Q2387X

N9x. IF R SOLD THE HOME (N8x/T135=2):
What was the selling price?

OTHERWISE:

What was the value of that house? I mean, what would it have brought if it had been sold?

[IWER: DO NOT PROBE DK/RF]

AMOUNT

|

DK

RF

|

GO TO N62x/T148

T141-T143 Unfolding Sequence

Question text: Did it amount to a total of less than \$____, more than \$____, or what?

PROCEDURE: 1Up1Down

BREAKPOINTS: \$15,000, \$50,000, \$200,000

ENTRY POINT: \$50,000

N10x/T144 BRANCHPOINT: GO TO N62x/T148

T144
Q2391X

N10x. Is that home now vacant, or is someone living there?

| | | | |
|-----------------|-------------|-----------------|-------|
| 1. VACANT | 5. OCCUPIED | 8. DK | 9. RF |
| | | | |
| GO TO N62x/T148 | | GO TO N62x/T148 | |

T145
Q2392X

N10ax. Who lives in the house, (that is, what was their relationship to R's FIRST NAME)?

[IWER: CHOOSE ALL THAT APPLY]

| | | | |
|------------|--------------------------------------|-------------------|-----------|
| 1. SPOUSE | 2. CHILD/CHILD-IN-LAW/ GRANDCHILD | 3. OTHER RELATIVE | 4. FRIEND |
| 5. CHARITY | 7. SOMEONE ELSE | 8. DK | 9. RF |

N10bx/T146 BRANCHPOINT: IF PROXY DID NOT REPORT THAT CHILD/GRANDCHILD LIVES IN HOUSE (N10ax/T145 NOT 2), GO TO N62x/T148

T152
Q2417X

N62ex. Excluding life insurance, were any of these costs covered by insurance?

| | | | |
|--------|-------|-------|-------|
| 1. YES | 5. NO | 8. DK | 9. RF |
|--------|-------|-------|-------|

|

| |
|-----------------|
| GO TO N71x/T155 |
|-----------------|

T153
Q2418X

N62fx. How much did insurance pay?

| | | | | |
|---------------------------------|----|----------------------------------|----|----|
| _____ | OR | _____ | DK | RF |
| T153 Q2418X N62fx. AMOUNT | | T154 Q2419X N62gx. PERCENT | | |

T155
Q2421X

N71x. Sometimes people make provision to leave things to specific family members if something happens to them, others do not. Because we are trying to get a complete picture of family situations, I have a few questions about inheritance.

Before [his/her] death, had *R's FIRST NAME* put any of [his/her] assets into a trust?

| | | | |
|--------|-------|-------|-------|
| 1. YES | 5. NO | 8. DK | 9. RF |
|--------|-------|-------|-------|

T156
Q2426X

N72x. IF R PUT ASSETS INTO TRUST (N71x/T155=1):
In addition to the trust, did *R's FIRST NAME* have a will that was written and witnessed?

OTHERWISE:
Did *R's FIRST NAME* have a will that was written and witnessed?

| | | | |
|--------|-------|-------|-------|
| 1. YES | 5. NO | 8. DK | 9. RF |
|--------|-------|-------|-------|

| | |

| |
|-----------------------------|
| GO TO N73x/T161 BRANCHPOINT |
|-----------------------------|

T157
Q2427X
N72ax. Has [his/her] will been probated?

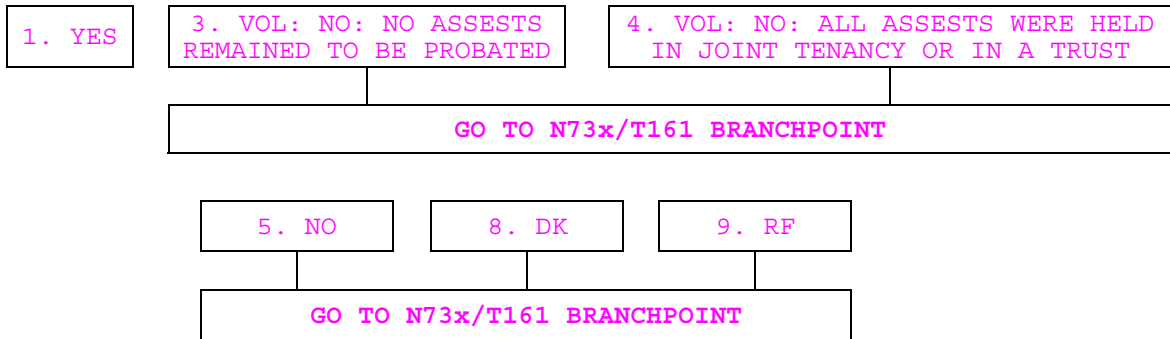

T158
Q2428X
N72bx. In what state was it probated?

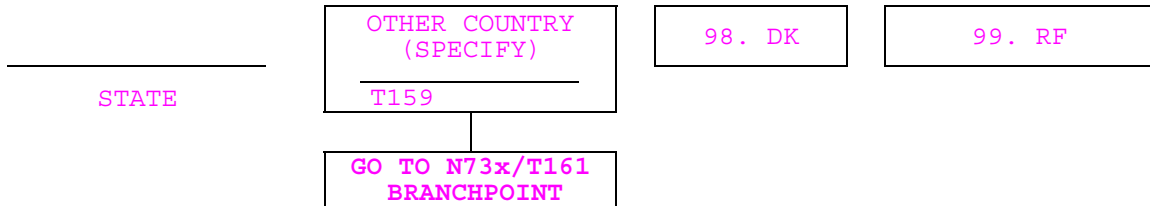

NOTE: THE IWER SELECTS FROM A MENU OF STATE NAMES, INCLUDING WASHINGTON, D.C., AND PUERTO RICO.

T160
Q2429X
N72cx. In what county was it probated?

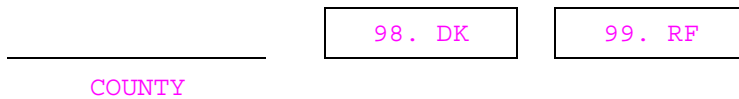

N73x/T161 BRANCHPOINT: IF R HAD {A TRUST or A PROBATED WILL} ({N71x/T155 or N72ax/T157}=1), GO TO N74x/T163 LOOP BRANCHPOINT

T161
Q2430X

N73x. IF R OWNED OWN HOME IN HH'S LAST IW (Z132=1):
The next questions are about R's FIRST NAME's assets and possessions,
excluding [his/her] home and any life insurance.

OTHERWISE:
The next questions are about R's FIRST NAME's assets and possessions,
excluding any life insurance.

ASK ALL PROXIES:
Have they been divided up among the heirs, have they not yet been
distributed, was there nothing of much value to distribute, or what?

| | | | |
|--|-------------------------------------|-------|-------|
| 1. DIVIDED AMONG THE HEIRS, OR RETAINED BY THOSE WITH JOINT TENANCY | 2. NOT YET DISTRIBUTED | | |
| 3. NOTHING MUCH OF VALUE | 7. OTHER (SPECIFY) _____ T162 | 8. DK | 9. RF |

N74x/T163 LOOP BRANCHPOINT: IF {R HAD NEITHER A TRUST NOR A WILL ({N71x/T155 and N72ax/T157} NOT 1)} and {{ASSETS/POSSESSIONS WERE NOT DIVIDED AMONG HEIRS and THE RESPONSE WAS NOT OTHER (SPECIFY)} (N73x/T161 {NOT 1 and NOT 7})}, GO TO N83x/T181 BRANCHPOINT

IF R WAS NOT PART OF A COUPLE (X065 {NOT 1 and NOT 2 and NOT 3 and NOT 4}), GO TO N75x/T164 BRANCHPOINT

***BEGINNING OF N74x/T163 LOOP: ESTATE DISPERSAL

N74x/T163 THROUGH N81fx/T908-8 ARE ASKED FOR POTENTIAL BENEFICIARIES OF R'S ESTATE.

T163
Q2432X

N74x. IF R HAD {A TRUST and/or A WILL} ({N71x/T155 and N72x/T156}=1 or N71x/T155=1 or N72x/T156=1):
Did [he/she] make provisions in [either the trust or the will/the trust/the will] for [you/[[his/her] [husband/wife/partner]]]?

OTHERWISE:

Were any of [his/her] possessions or assets left to [you/[[his/her] [husband/wife/partner]]]?

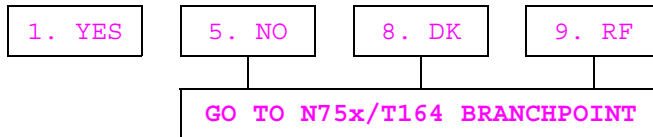

***BEGINNING OF BLOCK_1: AMOUNT TO SPOUSE/PARTNER
(N74ax/T902_1 - N74fx/T908_1)

T902_1
Q2433X

N74ax. Excluding ([his/her] home and) any life insurance, how much did [you/[[his/her] [husband/wife/partner]]] receive from [his/her] estate?

[IWER: ACCEPT EITHER A DOLLAR AMOUNT OR A PERCENTAGE]

[IWER: DO NOT PROBE DK/RF]

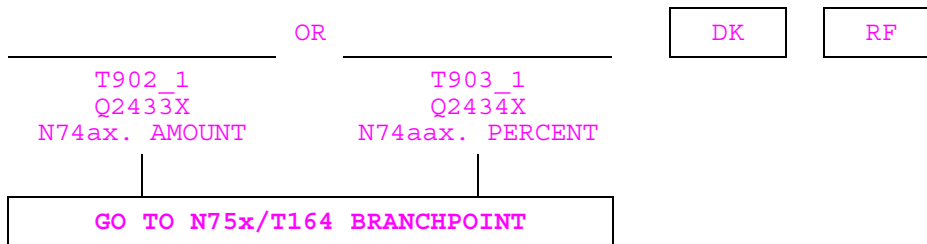

T904_1
Q2436X

N74bx. Was it more than half of [his/her] estate?

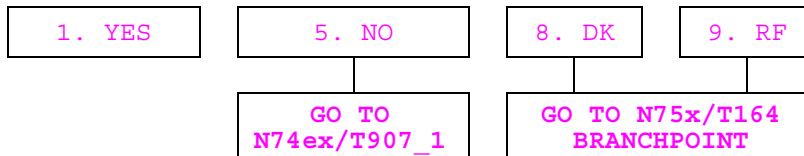

T905_1
Q2437X

N74cx. Was it more than 75 percent of [his/her] estate?

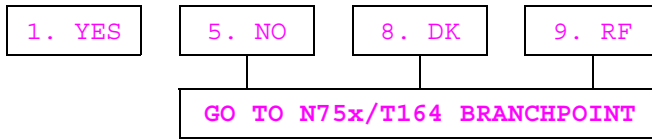

T906_1
Q2438X

N74dx. Was it more than 90 percent of [his/her] estate?

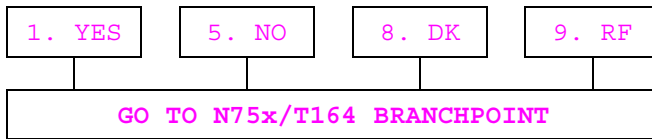

T907_1
Q2439X

N74ex. Was it more than 25 percent of [his/her] estate?

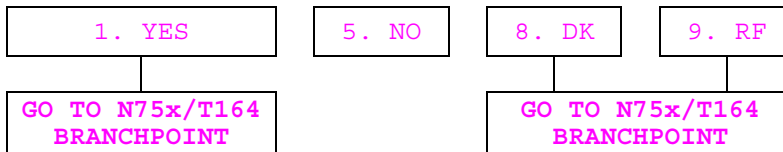

T908_1
Q2440X

N74fx. Was it more than 10 percent of [his/her] estate?



***END OF BLOCK_1: AMOUNT TO SPOUSE/PARTNER (N74ax/T902_1 - N74fx/T908_1)

***BEGINNING OF BLOCK 2: SAME AMOUNT TO ALL CHILDREN
(N75bx/T902_2 - N75gx/T908_2)

T902_2
Q2444X

N75bx. Altogether, how much did [he/she] leave for [his/her] [child
(grandchild)/children (grandchildren)]?

[IWER: ACCEPT EITHER A DOLLAR AMOUNT OR A PERCENTAGE]

[IWER: DO NOT PROBE DK/RF]

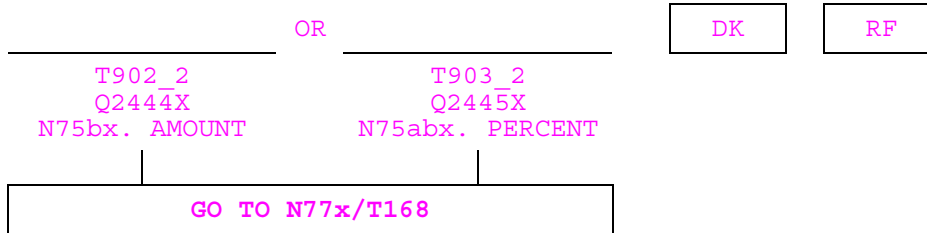

T904_2
Q2447X

N75cx. Was it more than half of [his/her] estate?

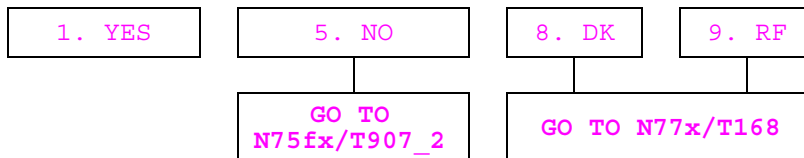

T905_2
Q2448X

N75dx. Was it more than 75 percent of [his/her] estate?

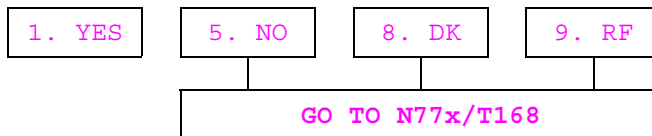

T906_2
Q2449X

N75ex. Was it more than 90 percent of [his/her] estate?

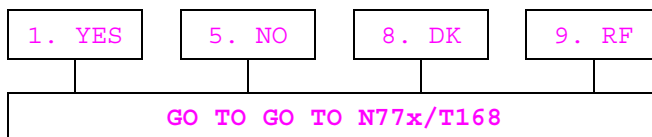

T907_2
Q2450X

N75fx. Was it more than 25 percent of [his/her] estate?

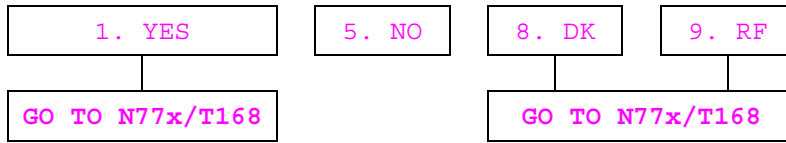

T908_2
Q2451X

N75gx. Was it more than 10 percent of [his/her] estate?

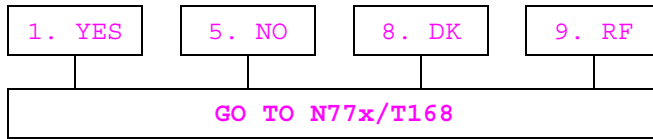

***END OF BLOCK_2: SAME AMOUNT TO ALL CHILDREN (N75bx/T902_2 - N75gx/T908_2)

N76ax/T902_3 LOOP BRANCHPOINT: GO TO N77x/T168

***BEGINNING OF N76ax/T902_3 LOOP: ESTATE DISPERSAL TO EACH CHILD
N75bx/T902_2 - N75gx/T908_2 ARE ASKED FOR EACH CHILD

***BEGINNING OF BLOCK_3: AMOUNT TO EACH CHILD
(N76ax/T902_3 - N76fx/T908_3)

T902_3
Q2455X

N76ax. (Excluding ([his/her] home and) any life insurance,) how much did [he/she] leave for CHILDn's NAME and (his/her) family?

[IWER: ACCEPT EITHER A DOLLAR AMOUNT OR A PERCENTAGE]

[IWER: DO NOT PROBE DK/RF]

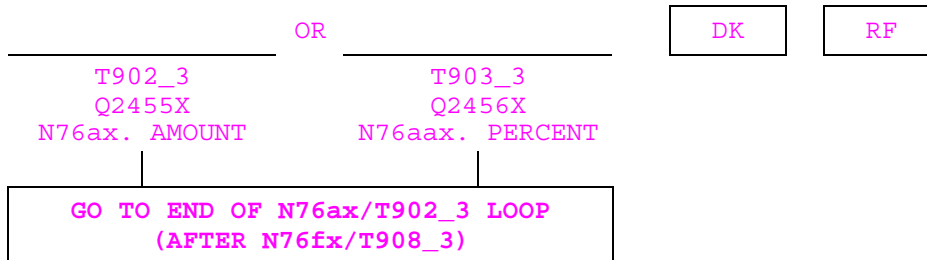

T904_3
Q2458X

N76bx. Was it more than half of [his/her] estate?

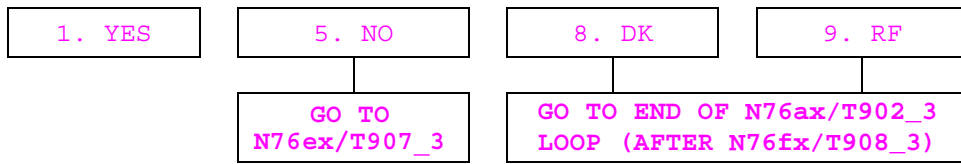

T905_3
Q2459X

N76cx. Was it more than 75 percent of [his/her] estate?

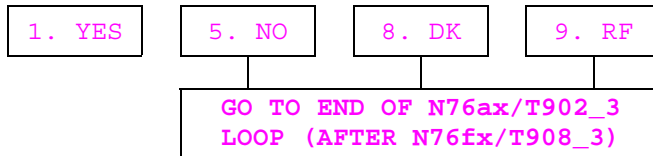

T906_3
Q2460X

N76dx. Was it more than 90 percent of [his/her] estate?

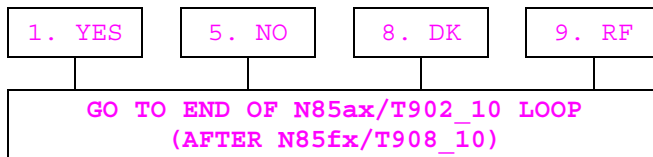

T907_3
Q2461X

N76ex. Was it more than 25 percent of [his/her] estate?

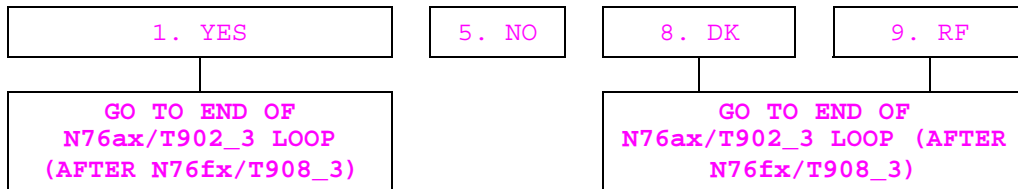

T908_3
Q2462X

N76fx. Was it more than 10 percent of [his/her] estate?



***END OF BLOCK_3: AMOUNT TO EACH CHILD (N76ax/T902_3 - N76fx/T908_3)

***END OF N76ax/T902_3 LOOP: ESTATE DISPERSAL TO EACH CHILD
IF THERE ARE NO MORE CHILDREN, CONTINUE ON TO N77x/T168. OTHERWISE, GO BACK TO BEGINNING OF N76ax/T902_3 LOOP

T168
Q2465X

N77x. IF R HAD {A TRUST and/or A WILL} ({N71x/T155 and N72x/T156}=1 or N71x/T155=1 or N72x/T156=1):
(Excluding ([his/her] home and) any life insurance,) did [he/she] make provisions in [either the trust or the will/the trust/the will] for charities?

OTHERWISE:

(Excluding ([his/her] home and) any life insurance,) were any of [his/her] possessions left to charities?

| | | | |
|-----------------|-------|-------|-------|
| 1. YES | 5. NO | 8. DK | 9. RF |
| GO TO N78x/T169 | | | |

***BEGINNING OF BLOCK 4: AMOUNT TO CHARITIES
(N77ax/T902_4 - N77fx/T908_4)

T902_4
Q2466X

N77ax. How much did charities receive from [his/her] estate?

[IWER: ACCEPT EITHER A DOLLAR AMOUNT OR A PERCENTAGE]

[IWER: DO NOT PROBE DK/RF]

| | | | | |
|-----------------------------------|----|-------------------------------------|----|----|
| _____ | OR | _____ | DK | RF |
| T902_4 Q2466X N77ax. AMOUNT | | T903_4 Q2467X N77aax. PERCENT | | |
| GO TO N78x/T169 | | | | |

T904_4
Q2469X

N77bx. Was it more than half of [his/her] estate?

| | | | |
|--------|--------------------|-----------------|-------|
| 1. YES | 5. NO | 8. DK | 9. RF |
| | GO TO N77ex/T907_4 | GO TO N78x/T169 | |

T905_4
Q2470X

N77cx. Was it more than 75 percent of [his/her] estate?

| | | | |
|-----------------|-------|-------|-------|
| 1. YES | 5. NO | 8. DK | 9. RF |
| GO TO N78x/T169 | | | |

T906_4
Q2471X

N77dx. Was it more than 90 percent of [his/her] estate?

| | | | |
|-----------------|-------|-------|-------|
| 1. YES | 5. NO | 8. DK | 9. RF |
| GO TO N78x/T169 | | | |

T907_4
Q2472X

N77ex. Was it more than 25 percent of [his/her] estate?

| | | | |
|-----------------|-------|-----------------|-------|
| 1. YES | 5. NO | 8. DK | 9. RF |
| GO TO N78x/T169 | | GO TO N78x/T169 | |

T908_4
Q2473X

N77fx. Was it more than 10 percent of [his/her] estate?

| | | | |
|--------|-------|-------|-------|
| 1. YES | 5. NO | 8. DK | 9. RF |
|--------|-------|-------|-------|

***END OF BLOCK_4: AMOUNT TO CHARITIES (N77ax/T902_4 - N77fx/T908_4)

T169
Q2475X

N78x. IF R HAD {A TRUST and/or A WILL} ({N71x/T155 and N72x/T156}=1 or N71x/T155=1 or N72x/T156=1):
(Excluding ([his/her] home and) any life insurance,) did [he/she] make provisions in [either the trust or the will/the trust/the will] for any of [his/her] brothers or sisters??

OTHERWISE:

(Excluding ([his/her] home and) any life insurance,) were any of [his/her] possessions left to any of [his/her] brothers or sisters??

| | | | |
|-----------------|-------|-------|-------|
| 1. YES | 5. NO | 8. DK | 9. RF |
| GO TO N79x/T170 | | | |

***BEGINNING OF BLOCK 5: AMOUNT TO SIBLINGS
(N78ax/T902_5 - N78fx/T908_5)

T902_5
Q2476X

N78ax. Altogether, how much did [his/her] brothers and sisters receive from [his/her] estate?

[IWER: ACCEPT EITHER A DOLLAR AMOUNT OR A PERCENTAGE]

[IWER: DO NOT PROBE DK/RF]

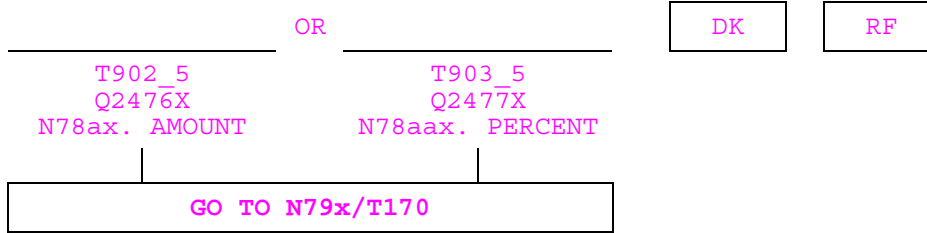

T904_5
Q2479X

N78bx. Was it more than half of [his/her] estate?

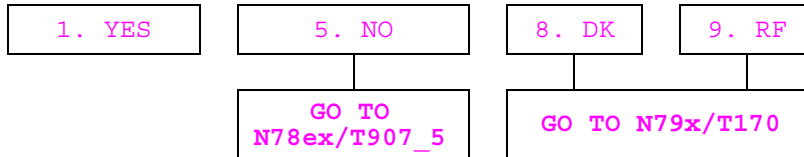

T905_5
Q2480X

N78cx. Was it more than 75 percent of [his/her] estate?



T906_5
Q2481X

N78dx. Was it more than 90 percent of [his/her] estate?

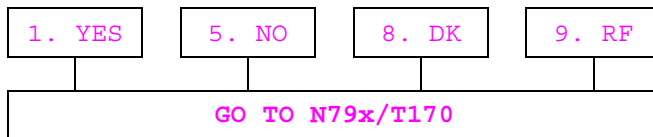

T907_5
Q2482X

N78ex. Was it more than 25 percent of [his/her] estate?

| | | | |
|-----------------|-------|-----------------|-------|
| 1. YES | 5. NO | 8. DK | 9. RF |
| GO TO N79x/T170 | | GO TO N79x/T170 | |

T908_5
Q2483X

N78fx. Was it more than 10 percent of [his/her] estate?

| | | | |
|--------|-------|-------|-------|
| 1. YES | 5. NO | 8. DK | 9. RF |
|--------|-------|-------|-------|

***END OF BLOCK_5: AMOUNT TO SIBLINGS (N78ax/T902_5 - N78fx/T908_5)

T170
Q2485X

N79x. IF R HAD {A TRUST and/or A WILL} ({N71x/T155 and N72x/T156}=1 or N71x/T155=1 or N72x/T156=1):
(Excluding ([his/her] home and) any life insurance,) did [he/she] make provisions in [either the trust or the will/the trust/the will] for any other of [his/her] relatives?

OTHERWISE:

Excluding ([his/her] home and) any life insurance,) were any of [his/her] possessions left to any other of [his/her] relatives?

| | | | |
|-----------------|-------|-------|-------|
| 1. YES | 5. NO | 8. DK | 9. RF |
| GO TO N80x/T171 | | | |

***BEGINNING OF BLOCK_6: AMOUNT TO OTHER RELATIVES
(N79ax/T902_6 - N79fx/T908_6)

T902_6
Q2486X

N79ax. Altogether, how much did these other relatives receive from [his/her] estate?

[IWER: ACCEPT EITHER A DOLLAR AMOUNT OR A PERCENTAGE]

[IWER: DO NOT PROBE DK/RF]

| | | | | |
|-----------------------------------|----|-------------------------------------|----|----|
| _____ | OR | _____ | DK | RF |
| T902_6 Q2486X N79ax. AMOUNT | | T903_6 Q2487X N79aax. PERCENT | | |
| GO TO N80x/T171 | | | | |

T904_6

Q2489X

N79bx. Was it more than half of [his/her] estate?

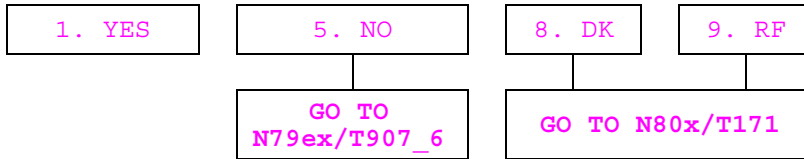

T905_6

Q2490X

N79cx. Was it more than 75 percent of [his/her] estate?

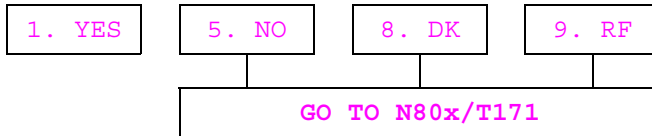

T906_6

Q2491X

N79dx. Was it more than 90 percent of [his/her] estate?

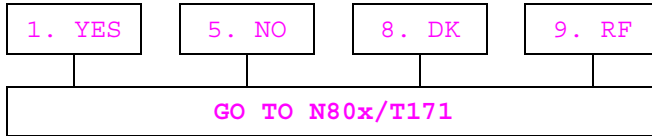

T907_6

Q2492X

N79ex. Was it more than 25 percent of [his/her] estate?

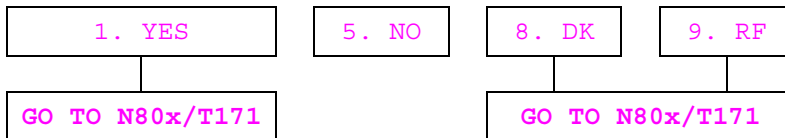

T908_6

Q2493X

N79fx. Was it more than 10 percent of [his/her] estate?



***END OF BLOCK_6: AMOUNT TO OTHER RELATIVES (N79ax/T902_6 - N79fx/T908_6)

T906_7
Q2501X

N80dx. Was it more than 90 percent of [his/her] estate?

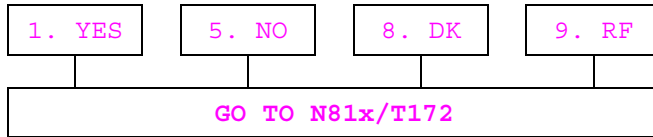

T907_7
Q2502X

N80ex. Was it more than 25 percent of [his/her] estate?

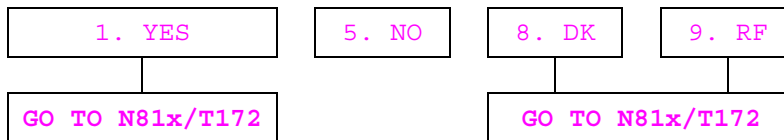

T908_7
Q2503X

N80fx. Was it more than 10 percent of [his/her] estate?



***END OF BLOCK_7: AMOUNT TO FRIENDS (N80ax/T902_7 - N80fx/T908_7)

T172
Q2505X

N81x. IF R HAD {A TRUST and/or A WILL} ({N71x/T155 and N72x/T156}=1 or N71x/T155=1 or N72x/T156=1):
(Excluding ([his/her] home and) any life insurance,) did [he/she] make provisions in [either the trust or the will/the trust/the will] for anyone else or anything else that we have not yet listed?

OTHERWISE:

Excluding ([his/her] home and) any life insurance,) were any of [his/her] possessions left to anyone else or anything else that we have not yet listed?

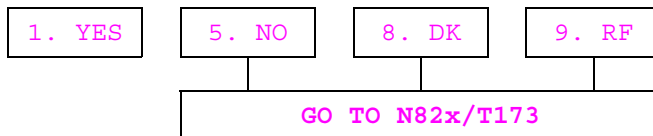

***BEGINNING OF BLOCK 8: AMOUNT TO OTHERS
(N81ax/T902_8 - N81fx/T908_8)

T902_8
Q2506X

N81ax. Altogether, how much did those others receive from [his/her] estate?

[IWER: ACCEPT EITHER A DOLLAR AMOUNT OR A PERCENTAGE]

[IWER: DO NOT PROBE DK/RF]

| | | | | |
|-----------------------------------|----|-------------------------------------|--------------------------|--------------------------|
| | OR | | <input type="checkbox"/> | <input type="checkbox"/> |
| T902_8 Q2506X N81ax. AMOUNT | | T903_8 Q2507X N81aax. PERCENT | DK | RF |
| GO TO N82x/T173 | | | | |

T904_8
Q2509X

N81bx. Was it more than half of [his/her] estate?

| | | | |
|--------|-----------------------|-----------------|-------|
| 1. YES | 5. NO | 8. DK | 9. RF |
| | GO TO N81ex/T907_8 | GO TO N82x/T173 | |

T905_8
Q2510X

N81cx. Was it more than 75 percent of [his/her] estate?

| | | | |
|--------|-----------------|-------|-------|
| 1. YES | 5. NO | 8. DK | 9. RF |
| | GO TO N82x/T173 | | |

T906_8
Q2511X

N81dx. Was it more than 90 percent of [his/her] estate?

| | | | |
|-----------------|-------|-------|-------|
| 1. YES | 5. NO | 8. DK | 9. RF |
| GO TO N82x/T173 | | | |

T907_8
Q2512X

N81ex. Was it more than 25 percent of [his/her] estate?

| | | | |
|-----------------|-------|-----------------|-------|
| 1. YES | 5. NO | 8. DK | 9. RF |
| GO TO N82x/T173 | | GO TO N82x/T173 | |

T908_8
Q2513X

N81fx. Was it more than 10 percent of [his/her] estate?

| | | | |
|--------|-------|-------|-------|
| 1. YES | 5. NO | 8. DK | 9. RF |
|--------|-------|-------|-------|

***END OF BLOCK_8: AMOUNT TO OTHERS (N81ax/T902_8 - N81fx/T908_8)

***END OF N74x/T163 ESTATE DISPERSAL LOOP. CONTINUE ON TO N82x/T173.

T173
Q2514X

N82x. Excluding ([his/her] home and) any life insurance, altogether, what was the value of [his/her] estate?

[IWER: DO NOT PROBE DK/RF]

| | | |
|------------------|----|----|
| _____ | DK | RF |
| AMOUNT | | |
| GO TO N82gx/T177 | | |

T174-T176 Unfolding Sequence

Question text: Did it amount to a total of less than \$____ , more than \$____ , or what?

PROCEDURE: 2Up2Down

BREAKPOINTS: \$10,000, \$25,000, \$100,000, \$500,000, \$2,000,000

ENTRY POINT: \$100,000

T177
Q2520X

N82gx. IF R PUT ASSETS INTO TRUST (N71x/T155=1):

Is any part of [his/her] estate still held in any type of a trust?

OTHERWISE:

Was any part of [his/her] estate put into a trust after [he/she] died?

| | | | |
|-----------------------------|-------|-------|-------|
| 1. YES | 5. NO | 8. DK | 9. RF |
| GO TO N83x/T181 BRANCHPOINT | | | |

T178
Q2521X

N82hx. Who is currently the trustee of this trust?

[IWER: CHOOSE ALL THAT APPLY]

| | | | |
|--|----------------------------|-------------------|-------------|
| 1. SPOUSE | 2. CHILD | 3. OTHER RELATIVE | 4. ATTORNEY |
| 5. BANK OFFICER/TRUST DEPARTMENT AT A BANK | 7. OTHER (SPECIFY) T179 | 8. DK | 9. RF |

N82jx/T180 BRANCHPOINT: IF PROXY DID NOT REPORT THAT TRUSTEE IS A CHILD (N82hx/T178 NOT 2), GO TO N83x/T181 BRANCHPOINT

T180
Q2522X

N82jx. (Which child is that?)

[IWER: CHOOSE ALL THAT APPLY]

| |
|--|
| CHILD NAME(S) [DISPLAYED BY BLAISE FROM PREVIOUS RESPONSES] |
| 3. THROUGH 42. CHILD NAME(S) [ROWS PROVIDED BY BLAISE AS NECESSARY] |
| 92. DECEASED CHILD |
| 93. ALL CHILDREN |
| 94. ALL GRANDCHILDREN EQUALLY |
| 97. OTHER (SPECIFY) [T238] |
| 98. DK |
| 99. RF |

NOTE: NAMES OF ALL LIVING AND DEAD CHILDREN ARE DISPLAYED. NAMES OF SPOUSE/PARTNERS OF CHILDREN ARE NOT DISPLAYED.

N83x/T181 BRANCHPOINT: IF THIS IS A POST-EXIT INTERVIEW (Z145={2 or 3 or 5}), GO TO END OF SECTION T

T181
Q2524X

N83x. IF R HAD {A TRUST or A WILL} (N71x/T155=1 or N72x/T156=1) or THE WILL HAS BEEN PROBATED (N72ax/T157=1) or {ASSETS AND POSSESSIONS} WERE DIVIDED AMONG THE HEIRS (N73x/T161=1):

In addition to what you have just told me about [his/her] estate did anyone receive a settlement from life insurance?

OTHERWISE:

Did anyone receive a settlement from life insurance?

| | | | |
|-----------------|-------|-------|-------|
| 1. YES | 5. NO | 8. DK | 9. RF |
| GO TO SX-1/T190 | | | |

T182
Q2525X

N83ax. Who were the beneficiaries of that life insurance?

[IWER: CHOOSE ALL THAT APPLY]

| | | | |
|----------------------|-----------------------------|---|-------|
| 1. SPOUSE/PARTNER | 2. CHILD (REN) | 3. GRANDCHILD (REN) OR GREAT-GRANDCHILD (REN) | |
| 4. OTHER RELATIVE(S) | 7. OTHER (SPECIFY) _____ | 8. DK | 9. RF |
| T183 | | | |

N84x/T184 BRANCHPOINT: IF PROXY DID NOT REPORT THAT BENEFICIARY IS CHILD (REN) OR GRANDCHILD (REN) (N83ax/T182 {NOT 2 and NOT 3}), GO TO N85gx/T902_11 BRANCHPOINT

T184
Q2526X

N84x. Did each of [his/her] children and their families receive the same amount from life insurance?

| | | | |
|--------|-------|-------|-------|
| 1. YES | 5. NO | 8. DK | 9. RF |
|--------|-------|-------|-------|

***BEGINNING OF N84ax/T902_9 LOOP: LIFE INSURANCE DISPERSAL
 N84ax/T902_9 THROUGH T908_13 ARE ASKED FOR EACH BENEFICIARY OF R'S LIFE
 INSURANCE.

N84ax/T902_9 BRANCHPOINT: IF PROXY DID NOT REPORT THAT CHILDREN RECEIVED SAME
 AMOUNT (N84x/T184 NOT 1) and R HAS MORE THAN ONE CHILD
 (A101>1), GO TO BEGINNING OF N85ax/T902_10 LOOP

***BEGINNING OF BLOCK_9: LIFE INSURANCE: SAME AMOUNT TO ALL CHILDREN
 (N84ax/T902_9 - N84fx/T908_9)

T902_9
 Q2527X

N84ax. Altogether, how much did [his/her] children receive from [his/her] life insurance?

[IWER: ACCEPT EITHER A DOLLAR AMOUNT OR A PERCENTAGE]

[IWER: DO NOT PROBE DK/RF]

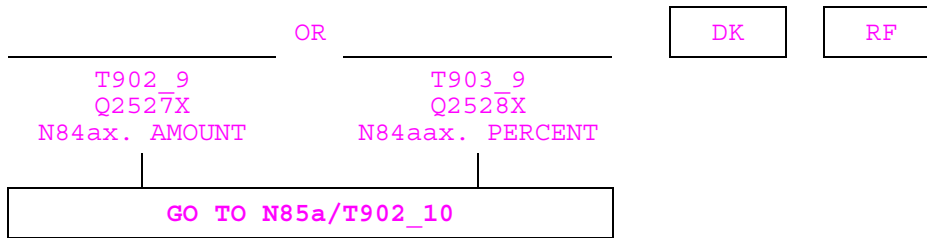

T904_9
 Q2530X

N84bx. Was it more than half of [his/her] estate?

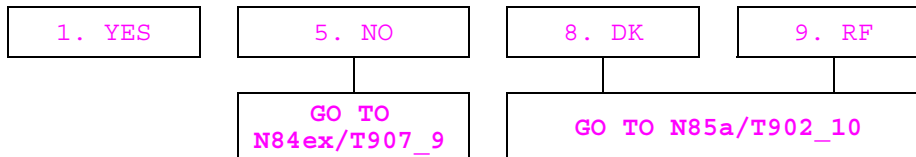

T905_9
 Q2531X

N84cx. Was it more than 75 percent of [his/her] estate?

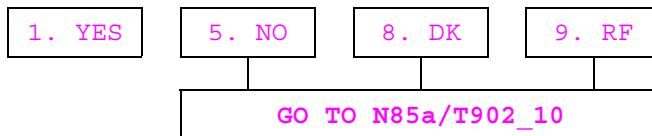

T906_9

Q2532X

N84dx. Was it more than 90 percent of [his/her] estate?



T907_9

Q2533X

N84ex. Was it more than 25 percent of [his/her] estate?

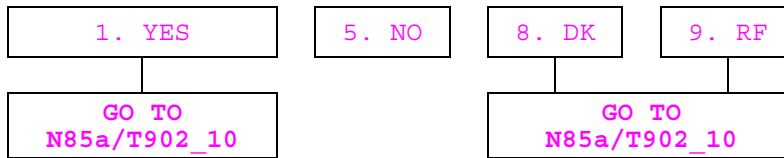

T908_9

Q2534X

N84fx. Was it more than 10 percent of [his/her] estate?



***END OF BLOCK 9: LIFE INSURANCE: SAME AMOUNT TO ALL CHILDREN
(N84ax/T902_9 - N84fx/T908_9)

N85ax/T902_10 LOOP BRANCHPOINT: GO TO N85gx/T902_11 BRANCHPOINT

*** BEGINNING OF N85ax/T902_10 LOOP: LIFE INSURANCE TO EACH CHILD
 N85ax/T902_10 THROUGH N85fx/T908_10 ARE ASKED FOR EACH CHILD.

***BEGINNING OF BLOCK 10: LIFE INSURANCE: AMOUNT TO EACH CHILD
 (N85ax/T902_10 - N85fx/T908_10)

T902_10
 Q2538X

N85ax. How much did *CHILDn NAME* and (his/her) family receive from life insurance?

[IWER: ACCEPT EITHER A DOLLAR AMOUNT OR A PERCENTAGE]

[IWER: DO NOT PROBE DK/RF]

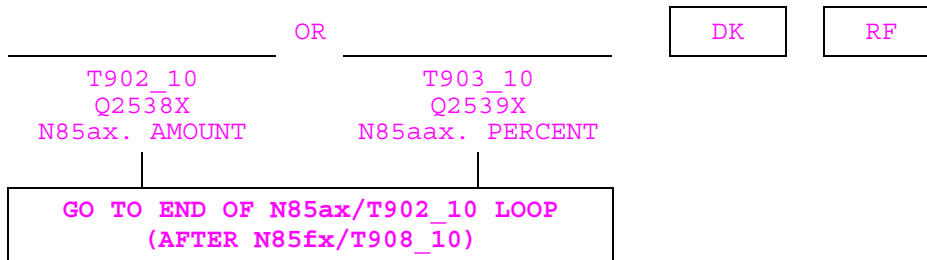

T904_10
 Q2541X

N85bx. Was it more than half of [his/her] estate?

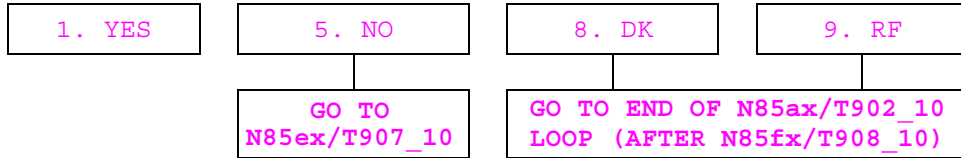

T905_10
 Q2542X

N85bcx. Was it more than 75 percent of [his/her] estate?

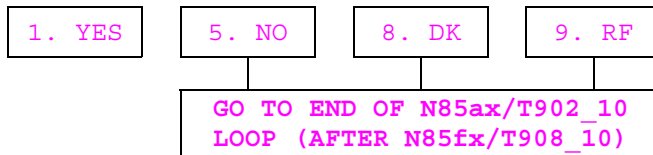

T906_10
 Q2543X

N85dx. Was it more than 90 percent of [his/her] estate?

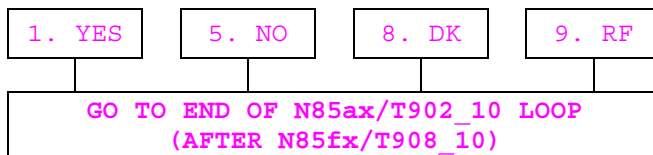

T907_10

Q2544X

N85ex. Was it more than 25 percent of [his/her] estate?

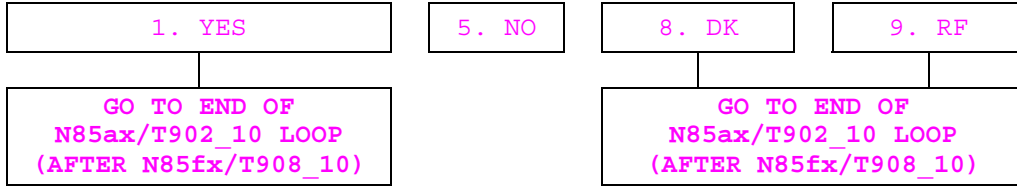

T908_10

Q2545X

N85fx. Was it more than 10 percent of [his/her] estate?



***END OF BLOCK_10: LIFE INSURANCE: AMOUNT TO EACH CHILD
(N85ax/T902_10 - N85fx/T908_10)

***END OF N85ax/T902_10 LOOP: LIFE INSURANCE TO EACH CHILD
IF THERE ARE NO MORE CHILDREN, CONTINUE ON TO N85gx/T902_11 BRANCHPOINT.
OTHERWISE, GO BACK TO BEGINNING OF N85ax/T902_10 LOOP

N85gx/T902_11 BRANCHPOINT: IF LIFE INSURANCE BENEFICIARY WAS R's SPOUSE/PARTNER
(N83ax/T182=1), CONTINUE ON TO N85gx/T902_11

OTHERWISE, GO TO N85hx/T902_12 BRANCHPOINT

***BEGINNING OF BLOCK_11: LIFE INSURANCE: AMOUNT TO SPOUSE/PARTNER
(N85gx/T902_11 - T908_11)

T902_11

Q2546X

N85gx. Altogether, how much did [you/[his/her] [husband/wife/partner]]
receive from [his/her] life insurance?

[IWER: ACCEPT EITHER A DOLLAR AMOUNT OR A PERCENTAGE]

[IWER: DO NOT PROBE DK/RF]

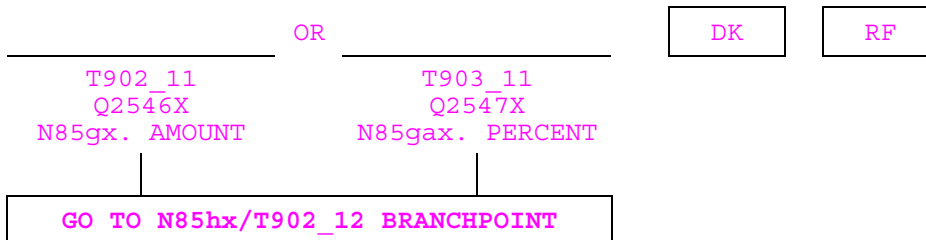

T904_11

Was it more than half of [his/her] estate?

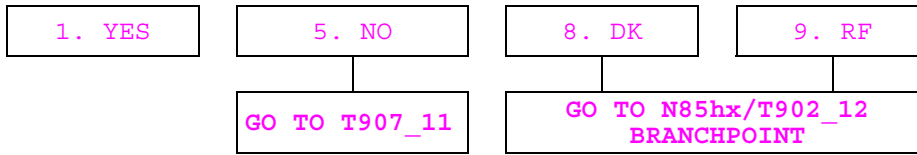

T905_11

Was it more than 75 percent of [his/her] estate?

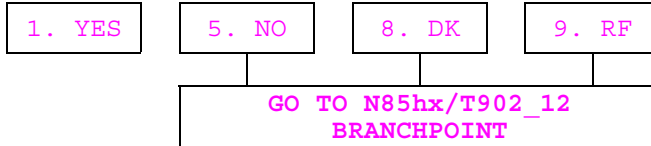

T906_11

Was it more than 90 percent of [his/her] estate?

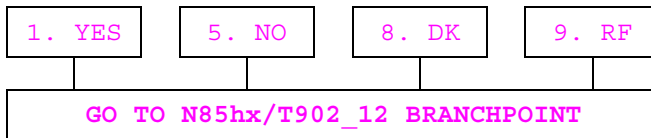

T907_11

Was it more than 25 percent of [his/her] estate?

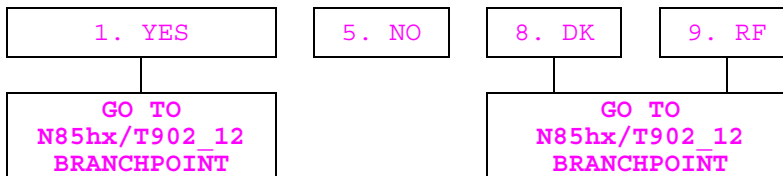

T908_11

Was it more than 10 percent of [his/her] estate?



***END OF **BLOCK 11**: LIFE INSURANCE: AMOUNT TO SPOUSE/PARTNER
(N85gx/T902_11 - T908_11)

N85hx/T902 12 BRANCHPOINT: IF R's LIFE INSURANCE BENEFICIARY WAS OTHER RELATIVE(S) (N83ax/T182=4)}, CONTINUE ON TO N85hx/T902 12 OTHERWISE, GO TO N85jx/T902_13 BRANCHPOINT

***BEGINNING OF BLOCK 12: LIFE INSURANCE: AMOUNT TO OTHER RELATIVES
(N85hx/T902_12 - T908_12)

T902_12

Q2549X

N85hx. Altogether, how much did [his/her] other relatives receive from
[his/her] life insurance?

[IWER: ACCEPT EITHER A DOLLAR AMOUNT OR A PERCENTAGE]

[IWER: DO NOT PROBE DK/RF]

_____ OR _____

| | |
|------------------------------------|-------------------------------------|
| T902_12 Q2549X N85hx. AMOUNT | T903_12 Q2550X N85hx. PERCENT |
|------------------------------------|-------------------------------------|

GO TO N85jx/T902_13 BRANCHPOINT

T904_12

Was it more than half of [his/her] estate?

| | | | |
|--------|-------|-------|-------|
| 1. YES | 5. NO | 8. DK | 9. RF |
|--------|-------|-------|-------|

GO TO T907_12

GO TO N85jx/T902_13 BRANCHPOINT

T905_12

Was it more than 75 percent of [his/her] estate?

| | | | |
|--------|-------|-------|-------|
| 1. YES | 5. NO | 8. DK | 9. RF |
|--------|-------|-------|-------|

GO TO N85jx/T902_13 BRANCHPOINT

T906_12

Was it more than 90 percent of [his/her] estate?

| | | | |
|--------|-------|-------|-------|
| 1. YES | 5. NO | 8. DK | 9. RF |
|--------|-------|-------|-------|

GO TO N85jx/T902_13

T907_12

Was it more than 25 percent of [his/her] estate?

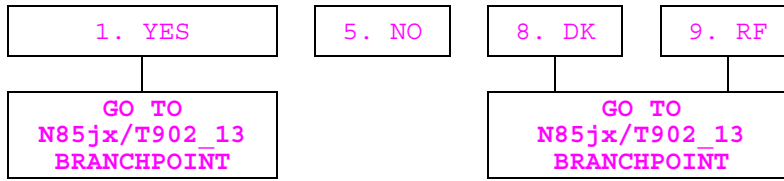

T908_12

Was it more than 10 percent of [his/her] estate?



***END OF BLOCK 12: LIFE INSURANCE: AMOUNT TO OTHER RELATIVES
(N85hx/T902_12 - T908_12)

N85jx/T902_13 BRANCHPOINT: IF RESPONSE TO LIFE INSURANCE BENEFICIARY WAS OTHER (SPECIFY) (N83ax/T182=7)}, CONTINUE ON TO N85jx/T902_13 OTHERWISE, GO TO N86ax/T186 BRANCHPOINT

***BEGINNING OF BLOCK 13: LIFE INSURANCE: AMOUNT TO NON-RELATIVES
(N85jx/T902_13 - T908_13)

T902_13
Q2552X

N85jx. Altogether, how much did other non-relatives receive from [his/her] life insurance?

[IWER: ACCEPT EITHER A DOLLAR AMOUNT OR A PERCENTAGE]

[IWER: DO NOT PROBE DK/RF]

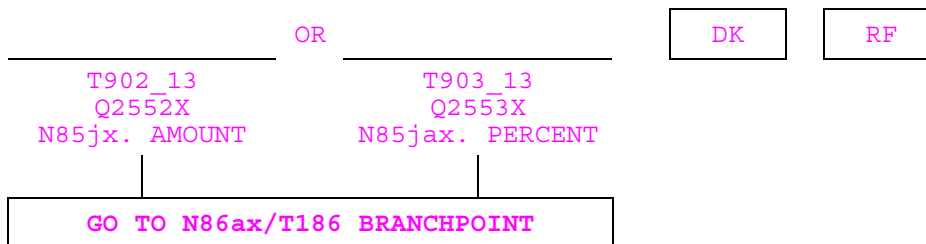

T904_13

Was it more than half of [his/her] estate?

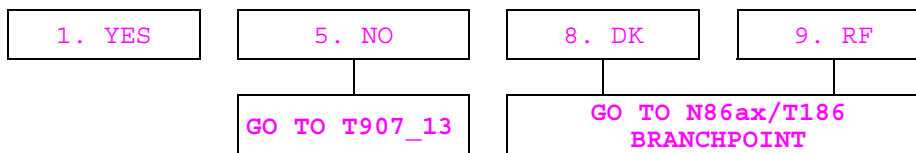

T905_13

Was it more than 75 percent of [his/her] estate?

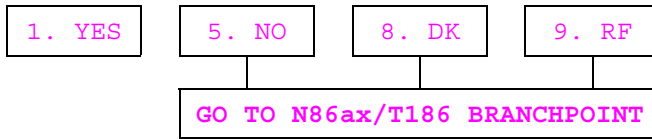

T906_13

Was it more than 90 percent of [his/her] estate?

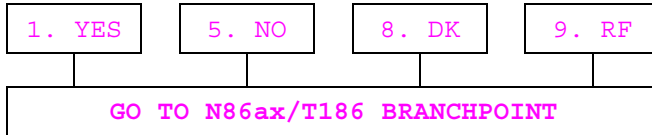

T907_13

Was it more than 25 percent of [his/her] estate?

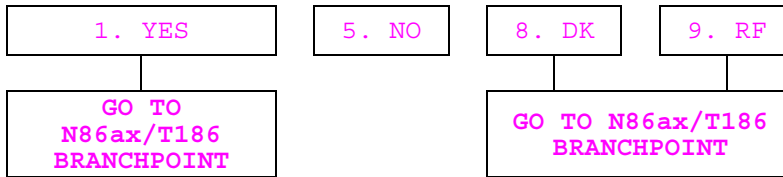

T908_13

Was it more than 10 percent of [his/her] estate?



***END OF **BLOCK_13: LIFE INSURANCE:** AMOUNT TO NON-RELATIVES
(N85jx/T902_13 - T908_13)

***END OF **N84ax/T902_9 LOOP: LIFE INSURANCE DISPERSAL.**
CONTINUE ON TO N86ax/T186.

N86ax/T186 BRANCHPOINT: IF R's SPOUSE/PARTNER WAS SOLE LIFE INSURANCE BENEFICIARY (N83ax/T182=1 ONLY) and A DOLLAR AMOUNT WAS GIVEN (N85gx/T902_11 ≥ 0), CONTINUE ON TO N86ax/T186

OTHERWISE, GO TO SX-1/T190

T186
Q2556X

N86ax. Altogether, what was the value of the life insurance settlement?

[IWER: DO NOT PROBE DK/RF]

AMOUNT

DK

RF

GO TO SX-1/T190

T187-T189 Unfolding Sequence

Question text: Did it amount to a total of less than \$____, more than \$____, or what?

PROCEDURE: 2Up2Down

BREAKPOINTS: \$10,000, \$25,000, \$100,000, \$500,000, \$2,000,000

ENTRY POINT: \$100,000

T190
Q2742X

SX-1. Now we wish to ask some questions about healthcare decisions toward the end of R's FIRST NAME's life.

Did R's FIRST NAME provide written instructions about the treatment or care [he/she] wanted to receive during the final days of [his/her] life?

[IWER: EMPHASIZE THE PHRASE WRITTEN INSTRUCTIONS]

1. YES

5. NO

8. DK

9. RF

GO TO SX-2/T206

T191
Q2743X

SX-1a. About when were these written instructions dated (approximately)?

T191
Q2743X
SX-1a. MONTH:

| | | | | | | |
|---------|---------|---------|---------|---------|---------|---------|
| 01. JAN | 02. FEB | 03. MAR | 04. APR | 05. MAY | 06. JUN | 07. JUL |
| 08. AUG | 09. SEP | 10. OCT | 11. NOV | 12. DEC | 98. DK | 99. RF |

DK

RF

T192
Q2744
SX-1a2. YEAR

T193
Q2749X
SX-1b.

| | 1. YES | 5. NO | 8. DK | 9. RF |
|--|--------|-------|-------|-------|
| T193 Q2749X SX-1b. Did these instructions express a desire to receive all care possible under any circumstances in order to prolong life? | | | | |
| T194 Q2750X SX-1c. Did these instructions express a desire to limit care in certain situations? | | | | |
| T195 Q2751X SX-1d. Did these instructions express a desire to have any treatment withheld? | | | | |
| T196 Q2752X SX-1e. (Did these instructions express a desire to) keep [him/her] comfortable and pain free but to forego extensive measures to prolong life? | | | | |

T197
Q2753X

SX-1f. Were these instructions applicable to the actual situation?

| | | | |
|-----------------|-------|-------|-------|
| 1. YES | 5. NO | 8. DK | 9. RF |
| GO TO SX-2/T206 | | | |

T198
Q2754X

SX-1g. Were you consulted about whether these instructions should be followed?

| | | | |
|--------|-------|-------|-------|
| 1. YES | 5. NO | 8. DK | 9. RF |
|--------|-------|-------|-------|

T199
Q2755X

SX-1h. Were any (other) family members or other persons consulted?

| | | | |
|------------------|-------|-------|-------|
| 1. YES | 5. NO | 8. DK | 9. RF |
| GO TO SX-1k/T204 | | | |

T200
 Q2756X
 SX-1ha. Who was this?

[IWER: CHECK ALL THAT APPLY]

Anyone else?

| | | | |
|-------------------|--------------------------------|--------------------------------------|---|
| 1. DECEASED R | 2. NON-SPOUSE PROXY RESPONDENT | 3. SPOUSE | 4. CHILD/CHILD-IN-LAW/ GRANDCHILD |
| 5. OTHER RELATIVE | 6. FRIEND | 7. PHYSICIAN/HEALTHCARE PROFESSIONAL | 8. MINISTER/RABBI/PRIEST/ RELIGIOUS ADVISOR |
| 9. ATTORNEY | 10. SOCIAL WORKER | 97. OTHER (SPECIFY) T201 | 98. DK |
| | | | 99. RF |

SX-1j/T202 BRANCHPOINT: IF PROXY DID NOT REPORT THAT A CHILD/GRANDCHILD WAS CONSULTED (SX-1ha/T200 NOT 4), GO TO SX-1k/T204

T202
 Q2757X
 SX-1j. Which child was that?

[IWER: CHOOSE ALL THAT APPLY]

| |
|--|
| CHILD NAME(S) [DISPLAYED BY BLAISE FROM PREVIOUS RESPONSES] |
| 3. THROUGH 42. CHILD NAME(S) [ROWS PROVIDED BY BLAISE AS NECESSARY] |
| 92. DECEASED CHILD |
| 93. ALL CHILDREN EQUALLY |
| 97. OTHER (SPECIFY) [T203] |
| 98. DK |
| 99. RF |

NOTE: NAMES OF ALL LIVING AND DEAD CHILDREN ARE DISPLAYED. NAMES OF SPOUSE/PARTNERS OF CHILDREN ARE NOT DISPLAYED.

T204
 Q2759X
 SX-1k. Did any problems come up in trying to follow these written instructions?

| | | | |
|-----------------|-------|-------|-------|
| 1. YES | 5. NO | 8. DK | 9. RF |
| GO TO SX-2/T206 | | | |

T205
Q2760X

SX-1m. Did the physician or any other health care worker have problems following the written instructions?

| | | | |
|--------|-------|-------|-------|
| 1. YES | 5. NO | 8. DK | 9. RF |
|--------|-------|-------|-------|

T206
Q2764X

SX-2. Did R's FIRST NAME (also) make any legal arrangements for a specific person or persons to make decisions about [his/her] care or medical treatment if [he/she] could not make those decisions [himself/herself]? This is sometimes called a Durable Power of Attorney for Health Care.

| | | | |
|-----------------|-------|-------|-------|
| 1. YES | 5. NO | 8. DK | 9. RF |
| GO TO SX-3/T213 | | | |

T207
Q2765X

SX-2a. Who had that authority?

| | | | | |
|-------------------|--------------------------------|--------------------------------------|---|--------|
| 1. DECEASED R | 2. NON-SPOUSE PROXY RESPONDENT | 3. SPOUSE | 4. CHILD/CHILD-IN-LAW/ GRANDCHILD | |
| 5. OTHER RELATIVE | 6. FRIEND | 7. PHYSICIAN/HEALTHCARE PROFESSIONAL | 8. MINISTER/RABBI/PRIEST/ RELIGIOUS ADVISOR | |
| 9. ATTORNEY | 10. SOCIAL WORKER | 97. OTHER (SPECIFY) _____ T208 | 98. DK | 99. RF |

SX-2b/T209 BRANCHPOINT: IF PROXY DID NOT REPORT THAT A CHILD/GRANDCHILD WAS CONSULTED (SX-2a/T207 NOT 4), GO TO SX-2c/T211

T209
 Q2766X
 SX-2b. Which child is that?

[IWER: CHOOSE ALL THAT APPLY]

| |
|--|
| CHILD NAME(S) [DISPLAYED BY BLAISE FROM PREVIOUS RESPONSES] |
| 3. THROUGH 42. CHILD NAME(S) [ROWS PROVIDED BY BLAISE AS NECESSARY] |
| 92. DECEASED CHILD |
| 93. ALL CHILDREN EQUALLY |
| 97. OTHER (SPECIFY) [T210] |
| 98. DK |
| 99. RF |

NOTE: NAMES OF ALL LIVING AND DEAD CHILDREN ARE DISPLAYED. NAMES OF SPOUSE/PARTNERS OF CHILDREN ARE NOT DISPLAYED.

T211
 Q2768X
 SX-2c. When was the Durable Power of Attorney for Health Care made (approximately)?

T211
 Q2768X
 SX-1a. MONTH:

| | | | | | | |
|---------|---------|---------|---------|---------|---------|---------|
| 01. JAN | 02. FEB | 03. MAR | 04. APR | 05. MAY | 06. JUN | 07. JUL |
| 08. AUG | 09. SEP | 10. OCT | 11. NOV | 12. DEC | 98. DK | 99. RF |

_____ DK RF

T212
 Q2768X
 SX-2c2. YEAR

T213
 Q2775X
 SX-3. Did R's FIRST NAME ever discuss with you or anyone else the treatment or care [he/she] wanted to receive in the final days of [his/her] life?

| | | | |
|-----------------|-------|-------|-------|
| 1. YES | 5. NO | 8. DK | 9. RF |
| GO TO SX-4/T218 | | | |

T214
Q2776X
SX-3a. Who was that?

[IWER: CHOOSE ALL THAT APPLY]

| | | |
|--|-------------------|---|
| 2. NON-SPOUSE PROXY RESPONDENT | 3. SPOUSE | 4. CHILD/CHILD-IN-LAW/ GRANDCHILD |
| 5. OTHER RELATIVE | 6. FRIEND | 7. PHYSICIAN/HEALTHCARE PROFESSIONAL |
| 8. MINISTER/RABBI/PRIEST/ RELIGIOUS ADVISOR | | |
| 9. ATTORNEY | 10. SOCIAL WORKER | 97. OTHER (SPECIFY) _____ |
| | | T215 |
| | | 98. DK |
| | | 99. RF |

SX-3b/T216 BRANCHPOINT: IF PROXY DID NOT REPORT THAT A CHILD/GRANDCHILD WAS CONSULTED (SX-3a/T214 NOT 4), GO TO SX-4/T218

T216
Q2777X
SX-3b. Which child is that?

[IWER: CHOOSE ALL THAT APPLY]

| |
|--|
| CHILD NAME(S) [DISPLAYED BY BLAISE FROM PREVIOUS RESPONSES] |
| 3. THROUGH 42. CHILD NAME(S) [ROWS PROVIDED BY BLAISE AS NECESSARY] |
| 92. DECEASED CHILD |
| 93. ALL CHILDREN EQUALLY |
| 97. OTHER (SPECIFY) [T217] |
| 98. DK |
| 99. RF |

NOTE: NAMES OF ALL LIVING AND DEAD CHILDREN ARE DISPLAYED. NAMES OF SPOUSE/PARTNERS OF CHILDREN ARE NOT DISPLAYED.

T218
Q2781X
SX-4. Did any decisions have to be made about the care and treatment of R's FIRST NAME during the final days of [his/her] life?

| | | | |
|------------------|-------|-------|-------|
| 1. YES | 5. NO | 8. DK | 9. RF |
| GO TO SX-10/T237 | | | |

T219
Q2782X

SX-5. Who was actually involved in making decisions about the care and treatment of R's FIRST NAME during the final days of [his/her] life?

(Who else participated?)

[IWER: CHOOSE ALL THAT APPLY]

| | | | | |
|-------------------|--------------------------------|--------------------------------------|---|--------|
| 1. DECEASED R | 2. NON-SPOUSE PROXY RESPONDENT | 3. SPOUSE | 4. CHILD/CHILD-IN-LAW/ GRANDCHILD | |
| 5. OTHER RELATIVE | 6. FRIEND | 7. PHYSICIAN/HEALTHCARE PROFESSIONAL | 8. MINISTER/RABBI/PRIEST/ RELIGIOUS ADVISOR | |
| 9. ATTORNEY | 10. SOCIAL WORKER | 97. OTHER (SPECIFY) | 98. DK | 99. RF |

SX-5y1/T220 BRANCHPOINT: IF PROXY DID NOT REPORT "OTHER PERSON NOT ON LIST" (SX-5/T219 NOT 97), GO TO SX-5a/T221 BRANCHPOINT

T220
Q2783X

SX-5y1. (Who was the "OTHER PERSON NOT ON LIST"?)

OTHER PERSON

| | |
|----|----|
| DK | RF |
|----|----|

SX-5a/T221 BRANCHPOINT: IF PROXY DID NOT REPORT THAT A CHILD/GRANDCHILD WAS CONSULTED (SX-5/T219 NOT 4), GO TO SX-5b/T223 BRANCHPOINT

T221
Q2784X

SX-5a. Which child is that?

[IWER: CHOOSE ALL THAT APPLY]

| |
|--|
| CHILD NAME(S) [DISPLAYED BY BLAISE FROM PREVIOUS RESPONSES] |
| 3. THROUGH 42. CHILD NAME(S) [ROWS PROVIDED BY BLAISE AS NECESSARY] |
| 92. DECEASED CHILD |
| 93. ALL CHILDREN EQUALLY |
| 97. OTHER (SPECIFY) [T222] |
| 98. DK |
| 99. RF |

NOTE: NAMES OF ALL LIVING AND DEAD CHILDREN ARE DISPLAYED. NAMES OF SPOUSE/PARTNERS OF CHILDREN ARE NOT DISPLAYED.

SX-5b/T223 BRANCHPOINT: IF DECEASED R WAS AMONG THOSE CONSULTED (SX-5/T219=1), GO TO SX-6/T227 BRANCHPOINT

T223

Q2785X

SX-5b. Was R's FIRST NAME able to participate in decisions about [his/her] medical care during the final days of [his/her] life?

| | | | |
|--------|-------|-------|-------|
| 1. YES | 5. NO | 8. DK | 9. RF |
|--------|-------|-------|-------|

SX-5c/T224 BRANCHPOINT: IF {DECEASED R WAS ABLE TO PARTICIPATE IN MEDICAL DECISIONS IN FINAL DAYS or PROXY DID NOT SAY} (SX-5b/T223 NOT 5}, GO TO SX-6/T227 BRANCHPOINT

T224

Q2786X

SX-5c. For about how long before R's FIRST NAME died was [he/she] unable to participate in decisions about [his/her] medical care?

| | | | | | | |
|---------------|----|--------------|----|--------------|-----------------------------|-----------------------------|
| _____ | OR | _____ | OR | _____ | <input type="checkbox"/> DK | <input type="checkbox"/> RF |
| T224 | | T225 | | T226 | | |
| Q2786X | | Q2787X | | Q2788X | | |
| SX-5c. MONTHS | | SX-5c1. DAYS | | SX-5c2. YEAR | | |

SX-6/T227 BRANCHPOINT: IF AT LEAST TWO {PEOPLE OR CATEGORY OF PERSON} PARTICIPATED IN THE DECISIONS ({{BETWEEN QUESTIONS SX-5/T219 AND SX-5a/T221} AND SX-5b/T223=1} see NOTE, below), CONTINUE ON TO SX-6/T227

OTHERWISE, GO TO SX-7a/T230

NOTE: "AT LEAST TWO {PEOPLE OR CATEGORY OF PERSONS}" CAN BE
 (a) NUMBER OF SELECTIONS AT {SX-5/T219 or SX-5a/T221} > 1, or
 (b) SELECTION OF {"1. DECEASED R" AT SX-5/T219 or SX-5b/T223=1} IN ADDITION TO ONE OTHER SELECTION AT SX-5/T219, or
 (c) MORE THAN ONE CHILD SELECTED AT SX-5a/T221, WHICH CAN INCLUDE "92. DECEASED CHILD", or SELECTION OF "93. ALL CHILDREN EQUALLY" AT SX-5a/T221

T227
Q2793X
SX-6. Who was the main decision-maker?

| | | | | |
|-------------------|--------------------------------|--------------------------------------|---|--------|
| 1. DECEASED R | 2. NON-SPOUSE PROXY RESPONDENT | 3. SPOUSE | 4. CHILD/CHILD-IN-LAW/ GRANDCHILD | |
| 5. OTHER RELATIVE | 6. FRIEND | 7. PHYSICIAN/HEALTHCARE PROFESSIONAL | 8. MINISTER/RABBI/PRIEST/ RELIGIOUS ADVISOR | |
| 9. ATTORNEY | 10. SOCIAL WORKER | 97. OTHER (SPECIFY) | 98. DK | 99. RF |

NOTE: RESPONSE "1. DECEASED R" APPEARS ONLY IF PROXY SAID R WAS ABLE TO PARTICIPATE IN HIS/HER OWN DECISIONS (SX-5b=1).

SX-6b/T228 BRANCHPOINT: IF PROXY DID NOT REPORT THAT A CHILD/GRANDCHILD WAS CONSULTED (SX-6/T227 NOT 4) or PROXY GAVE FEWER THAN TWO RESPONSES TO SX-5a/T221, GO TO SX-7a/T230

T228
Q2794X
SX-6b. Which child is that?

| |
|--|
| CHILD NAME(S) [DISPLAYED BY BLAISE FROM PREVIOUS RESPONSES] |
| 3. THROUGH 42. CHILD NAME(S) [ROWS PROVIDED BY BLAISE AS NECESSARY] |
| 92. DECEASED CHILD |
| 93. ALL CHILDREN EQUALLY |
| 97. OTHER (SPECIFY) [T229] |
| 98. DK |
| 99. RF |

NOTE: NAMES OF ALL LIVING AND DEAD CHILDREN ARE DISPLAYED. NAMES OF SPOUSE/PARTNERS OF CHILDREN ARE NOT DISPLAYED.

T230
Q2796X
SX-7a. Did those last decisions involve a desire to give all care possible unconditionally in order to prolong life?

| | | | |
|--------|-------|-------|-------|
| 1. YES | 5. NO | 8. DK | 9. RF |
|--------|-------|-------|-------|

T231
Q2797X
SX-7b. Did those last decisions involve limiting care in certain situations?

| | | | |
|--------|-------|-------|-------|
| 1. YES | 5. NO | 8. DK | 9. RF |
|--------|-------|-------|-------|

T232
Q2798X

SX-7c. Did those last decisions involve withholding any treatment?

| | | | |
|--------|-------|-------|-------|
| 1. YES | 5. NO | 8. DK | 9. RF |
|--------|-------|-------|-------|

T233
Q2799X

SX-7d. Did those last decisions rest largely on keeping *R's FIRST NAME* comfortable and pain free without taking extensive measures to prolong life?

| | | | |
|--------|-------|-------|-------|
| 1. YES | 5. NO | 8. DK | 9. RF |
|--------|-------|-------|-------|

T234
Q2803X

SX-8. Did any doctor(s) recommend any care or treatment that the family or other decision-maker(s) ultimately refused?

| | | | |
|-----------------------------|-------|-------|-------|
| 1. YES | 5. NO | 8. DK | 9. RF |
| GO TO SX-9/T236 BRANCHPOINT | | | |

T235
Q2804X

SX-8a. Did *R's FIRST NAME* receive this treatment anyway?

| | | | |
|--------|-------|-------|-------|
| 1. YES | 5. NO | 8. DK | 9. RF |
|--------|-------|-------|-------|

SX-9/T236 BRANCHPOINT: IF PROXY DID NOT REPORT S/HE WAS INVOLVED WITH CARRYING OUT THE *R's HEALTH CARE INSTRUCTIONS* (SX-1g/T198 NOT 1) and PROXY DID NOT REPORT S/HE WAS INVOLVED IN OTHER CARE DECISIONS FOR THE *R* ({SX-2a/T207 and SX-3a/T214 and SX-5/T219 and SX-6/T227} NOT 2), GO TO SX-10/T237

T236
Q2805X

SX-9. Did cost enter into the decisions about what care or treatment [he/she] would receive in the final days of [his/her] life?

| | | | |
|--------|-------|-------|-------|
| 1. YES | 5. NO | 8. DK | 9. RF |
|--------|-------|-------|-------|

T237

Q2806x

SX-10. Thinking back over the course of *R's FIRST NAME's* life, what would you say were [his/her] greatest strengths?

| |
|--|
| |
| |
| |

| |
|----|
| DK |
|----|

| |
|----|
| RF |
|----|

GO TO SECTION U