

**NOTE: WHERE THERE IS MORE THAN ONE JUMP WITHIN A BRANCHPOINT BOX, THE JUMPS ARE TO BE APPLIED IN ORDER FROM THE TOP.**

G1. Now I'm going to ask you some questions about your current employment situation.

Are you working now, temporarily laid off, unemployed and looking for work, disabled and unable to work, retired, a homemaker, or what?

[IWER: DO NOT PROBE BUT CHOOSE ALL THAT APPLY]

1. WORKING NOW	2. UNEMPLOYED AND LOOKING FOR WORK	3. TEMPORARILY LAID OFF, ON SICK OR OTHER LEAVE	4. DISABLED	
5. RETIRED	6. HOMEMAKER	7. OTHER (SPECIFY) _____	8. DK	9. RF

G1a BRANCHPOINT: IF R DID NOT REPORT THAT IS UNEMPLOYED (G1 NOT 2), GO TO G1c BRANCHPOINT

G1a. In what month and year did you become unemployed?

[IWER: MONTHS ENTERED MUST BE BEFORE OR ON CURRENT IW MONTH, YEAR]

MONTH:

01. JAN	02. FEB	03. MAR	04. APR	05. MAY
06. JUN	07. JUL	08. AUG	09. SEP	10. OCT
11. NOV	12. DEC	98. DK	99. RF	
_____	DK	RF		

G1b. YEAR

G1c BRANCHPOINT: IF R DID NOT REPORT THAT IS {TEMPORARILY LAID OFF, ON SICK OR OTHER LEAVE} (G1 NOT 3), GO TO G1f BRANCHPOINT

G1c. Do you expect to go back to this job?

1. YES	5. NO	8. DK	9. RF
GO TO G1f BRANCHPOINT			

G1d. In what month and year did you last work on this job?

[IWER: MONTHS ENTERED MUST BE BEFORE OR ON *CURRENT IW MONTH, YEAR*]

MONTH:

01. JAN	02. FEB	03. MAR	04. APR	05. MAY
06. JUN	07. JUL	08. AUG	09. SEP	10. OCT
11. NOV	12. DEC	98. DK	99. RF	

\_\_\_\_\_ 

DK	RF
----	----

G1e. YEAR

G1f BRANCHPOINT: IF R DID NOT REPORT THAT IS CURRENTLY DISABLED (G1 NOT 4) or IF R WAS DISABLED AT R's LAST IW, GO TO G1h BRANCHPOINT

G1f. In what month and year did you become disabled?

[IWER: DO NOT PROBE FOR MONTH]

[IWER: MONTHS ENTERED MUST BE BEFORE OR ON *CURRENT IW MONTH, YEAR*]

MONTH:

01. JAN	02. FEB	03. MAR	04. APR	05. MAY
06. JUN	07. JUL	08. AUG	09. SEP	10. OCT
11. NOV	12. DEC	98. DK	99. RF	

\_\_\_\_\_ 

DK	RF
----	----

G1g. YEAR

G1h BRANCHPOINT: IF R DID NOT REPORT THAT IS CURRENTLY RETIRED (G1 NOT 5) or IF R WAS RETIRED AT R's LAST IW, GO TO G2 BRANCHPOINT

G1h. In what month and year did you retire?

MONTH:

01. JAN	02. FEB	03. MAR	04. APR	05. MAY
06. JUN	07. JUL	08. AUG	09. SEP	10. OCT
11. NOV	12. DEC	98. DK	99. RF	

\_\_\_\_\_ 

DK
----

RF
----

G1j. YEAR

G2 BRANCHPOINT: IF R IS WORKING NOW (G1=1) or IS {TEMPORARILY LAID OFF AND EXPECTS TO GO BACK TO WORK (G1c=1)}, ASSIGN 1 FOR G2 AND GO TO G3

IF R IS IN NURSING HOME and DOES NOT OWN HOME OUTSIDE NURSING HOME, ASSIGN 5 FOR G2 AND GO TO G5 BRANCHPOINT

G2. Are you doing any work for pay at the present time?

1. YES	5. NO	8. DK	9. RF
GO TO G5 BRANCHPOINT			

G3. [On the job you plan to go back to/On your current (main) job], do you work for someone else, are you self-employed, or what?

[IWER: IF R SAYS, "I RUN MY OWN BUSINESS" CHOOSE "SELF-EMPLOYED"]

1. SOMEONE ELSE	2. SELF-EMPLOYED	8. DK	9. RF
-----------------	------------------	-------	-------

G5 BRANCHPOINT: IF R IS CURRENTLY WORKING FOR SOMEONE ELSE (G3=1) and WAS WORKING FOR SOMEONE ELSE AT R's LAST IW, GO TO G19a BRANCHPOINT

IF R DID NOT REPORT THAT IS CURRENTLY WORKING FOR SOMEONE ELSE ({G2 & G3} NOT 1) and WAS WORKING FOR SOMEONE ELSE AT R's LAST IW, GO TO G26 BRANCHPOINT

IF R WAS SELF-EMPLOYED AT R's LAST IW and DID NOT REPORT THAT IS CURRENTLY SELF-EMPLOYED (G3 NOT 2), GO TO G5

OTHERWISE, GO TO G39 BRANCHPOINT

G5. According to our records, in R's LAST IW MONTH, YEAR you were self-employed.

In what month and year did you stop working for yourself?

[IWER: MONTHS ENTERED MUST BE BETWEEN R's LAST IW MONTH, YEAR AND CURRENT IW MONTH, YEAR.]

MONTH:

01. JAN	02. FEB	03. MAR	04. APR	05. MAY
06. JUN	07. JUL	08. AUG	09. SEP	10. OCT
11. NOV	12. DEC	96 . STILL WORKING FOR SELF (AS SECOND JOB)		
GO TO G5b				

97. DENIES BEING SELF-EMPLOYED AT PREVIOUS IW	98. DK	99. RF
GO TO G39 BRANCHPOINT		

_____	DK	RF
-------	----	----

G5a. YEAR

G5b BRANCHPOINT: IF NEW INTERVIEW R or R DENIES BEING SELF-EMPLOYED AT R's LAST IW (G5=97), GO TO G39 BRANCHPOINT

IF R STOPPED WORKING FOR SELF LESS THAN 2 MONTHS AFTER R's LAST IW (PER G5/G5a) or R DID NOT REPORT THAT IS STILL WORKING FOR SELF AS SECOND JOB (G5 NOT 96), GO TO G6

G5b. Were there any months since [CURRENT IW MONTH, 1996/R's LAST IW MONTH, YEAR] when you were not working for pay?

1. YES	5. NO	8. DK	9. RF
GO TO G39 BRANCHPOINT			

G5c. Which months were those?

[R's PREV WAVE DATE: MONTH, YEAR]

NOTE: MONTH AND YEAR OF R'S LAST IW IS DISPLAYED TO IWER.

[IWER: MONTHS ENTERED MUST BE BETWEEN [CURRENT IW MONTH, 1996/R'S LAST IW MONTH, YEAR] AND CURRENT IW MONTH, YEAR.]

[IWER: CHOOSE ALL THAT APPLY]

01. JAN 96	02. FEB 96	03. MAR 96	04. APR 96	05. MAY 96	06. JUN 96	07. JUL 96
08. AUG 96	09. SEP 96	10. OCT 96	11. NOV 96	12. DEC 96	13. JAN 97	14. FEB 97
15. MAR 97	16. APR 97	17. MAY 97	18. JUN 97	19. JUL 97	20. AUG 97	21. SEP 97
22. OCT 97	23. NOV 97	24. DEC 97	25. JAN 98	26. FEB 98	27. MAR 98	28. APR 98
29. MAY 98	30. JUN 98	31. JUL 98	32. AUG 98	33. SEP 98	34. OCT 98	35. NOV 98
36. DEC 98	37. ALL OF 1996 (AFTER PREV IW)		38. ALL OF 1997		39. ALL OF 1998 TO DATE	
40. MONTHS PRIOR TO 1996			97. OTHER (SPECIFY)		98. DK	99. RF

G6 BRANCHPOINT: GO TO G39 BRANCHPOINT

G6. Were you paid a regular salary or wages?

1. YES	5. NO	8. DK	9. RF
GO TO G7			

G6a. How much were you paid before taxes and other deductions?

[IWER: IF PER HOUR BE SURE TO ADD .00 FOR CENTS IF THERE ARE NONE]

[IWER: PROBE IF NECESSARY]

Was that per hour, week, month, or year?

\_\_\_\_\_

AMOUNT

DK	RF
GO TO G7	

G6b. PER:

01. HOUR	02. WEEK	03. EVERY TWO WEEKS/BI-WEEKLY	04. MONTH
06. YEAR	97. OTHER (SPECIFY) _____	98. DK	99. RF

G7. Did you receive some or all of the net earnings or profits?

1. YES	5. NO	8. DK	9. RF
GO TO G28			

G7a. (In addition to your regular salary,) How much did you receive from net earnings or profits?

[IWER: IF R HAS TROUBLE GIVING DOLLAR FIGURE, ASK:]

What did you earn the last year you worked?

[IWER: IF PER HOUR BE SURE TO ADD .00 FOR CENTS IF THERE ARE NONE]

[IWER: PROBE IF NECESSARY]

Was that per hour, week, month, or year?

_____	DK	RF
AMOUNT		
<div style="border: 1px solid black; padding: 5px; width: fit-content; margin: 0 auto;">GO TO G28</div>		

G7b. PER:

01. HOUR	02. WEEK	03. EVERY TWO WEEKS/BI-WEEKLY	04. MONTH
<div style="border: 1px solid black; padding: 5px; width: 100%;">GO TO G28</div>			
06. YEAR	97. OTHER (SPECIFY) _____	98. DK	99. RF
<div style="border: 1px solid black; padding: 5px; width: 100%;">GO TO G28</div>			

**NOTE:** WHILE ALL RESPONDENTS WERE SKIPPED PAST G19a — G19b BRANCHPOINT TO G19b, A SMALL AMOUNT (43 CASES) WERE ASKED THIS SECTION, DUE TO THE FACT THAT THE JUMP WAS ADDED AFTER THE FIELD PERIOD STARTED. THESE QUESTIONS ARE INCLUDED FOR THE BENEFIT OF THOSE CASES

G19a BRANCHPOINT: ALL R's GO TO G19b

G19a. According to our records, you were employed in R's LAST IW YEAR. Are you still working for that same employer?

1. YES	5. NO	7. DENIES WORKING AT PREVIOUS IW	8. DK	9. RF
--------	-------	-------------------------------------	-------	-------

G19a1. [IWER: READ TO ALL RESPONDENTS]

We would like to obtain complete information about fringe benefits for employees like you. In order to do this, we need the full name and address of your employer.

For whom do you work [now/on your main job]?

(What is the [company's/organization's] name?)

\_\_\_\_\_

DK	RF
GO TO G19	

EMPLOYER

G19a2. What is the address of the place where you work?

[IWER: PROBE IF NECESSARY]

I will need the mailing address, city, state, and zip code.

\_\_\_\_\_

DK	RF
GO TO G19b BRANCHPOINT	

G19a3. ADDRESS

\_\_\_\_\_

DK	RF
----	----

G19a4. CITY

\_\_\_\_\_

DK	RF
----	----

G19a5. STATE

\_\_\_\_\_

DK	RF
----	----

G19a6. ZIP

[IWER: DO NOT USE DASH IN PHONE NUMBER ENTER 999 FOR UNKNOWN AREA CODE]

\_\_\_\_\_

DK	RF
----	----

G19a7. PHONE NUMBER

G19b BRANCHPOINT: IF R WAS ASKED G19a, GO TO G20 BRANCHPOINT



G19b. According to our records, in *R's LAST IW MONTH, YEAR* you were working [for *R's LAST IW EMPLOYER NAME*/for an employer].

Are you still working there?

1. YES	5. NO	7. DENIES WORKING AT PREVIOUS IW	8. DK	9. RF
GO TO G26				

G19c BRANCHPOINT: IF WE DO NOT KNOW EMPLOYER NAME FROM *R's LAST IW*, GO TO G19d

G19c. Is the correct name of your employer *R's LAST IW EMPLOYER NAME*?

1. YES	5. NO	7. DENIES WORKING AT PREVIOUS IW	8. DK	9. RF
GO TO G19f				

G19d. READ TO ALL RESPONDENTS:  
We would like to obtain complete information about fringe benefits for employees like you. In order to do this, we need the full name and address of your employer.

For whom do you work [now/on your main job]?

(What is the [company's/organization's] name?)

\_\_\_\_\_

COMPANY NAME

DK	RF
GO TO G20 BRANCHPOINT	

G19f. What is the address of the place where you work?

[IWER: PROBE IF NECESSARY]

I will need the mailing address, city, state, and zip code.

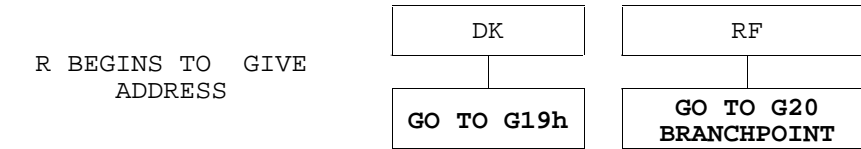

[IWER: DO NOT USE DASH IN PHONE NUMBER ENTER 999 FOR UNKNOWN AREA CODE]

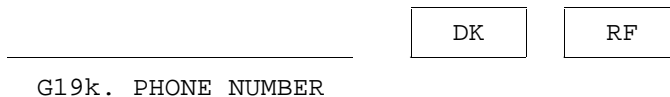

G20 BRANCHPOINT: IF R IS NOT STILL WORKING FOR SAME EMPLOYER AS R's LAST IW ({G19a or G19b}=5), GO TO G26 BRANCHPOINT

IF R DENIED THAT WORKED FOR PREVIOUSLY-LISTED EMPLOYER (G19b=7) or DID NOT SAY IF DID (G19b={DK or RF}), GO TO G39 BRANCHPOINT

G20. Were there any months since [CURRENT IW MONTH, 1996/R's LAST IW MONTH, YEAR] when you did not work for [R's LAST IW EMPLOYER NAME/R's CURRENT EMPLOYER NAME/that employer]?

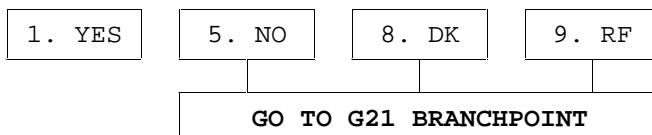

G20a. Which months were those?

[IWER: MONTHS ENTERED MUST BE BETWEEN R's LAST IW MONTH, YEAR AND CURRENT IW MONTH, YEAR]

[IWER: CHOOSE ALL THAT APPLY]

01. JAN 96	02. FEB 96	03. MAR 96	04. APR 96	05. MAY 96	06. JUN 96	07. JUL 96
08. AUG 96	09. SEP 96	10. OCT 96	11. NOV 96	12. DEC 96	13. JAN 97	14. FEB 97
15. MAR 97	16. APR 97	17. MAY 97	18. JUN 97	19. JUL 97	20. AUG 97	21. SEP 97
22. OCT 97	23. NOV 97	24. DEC 97	25. JAN 98	26. FEB 98	27. MAR 98	28. APR 98
29. MAY 98	30. JUN 98	31. JUL 98	32. AUG 98	33. SEP 98	34. OCT 98	35. NOV 98
36. DEC 98	37. ALL OF 1996 (AFTER PREV IW)		38. ALL OF 1997		39. ALL OF 1998 TO DATE	
40. MONTHS PRIOR TO 1996			97. OTHER (SPECIFY)		98. DK	99. RF

G21 BRANCHPOINT: IF NO JOB TITLE GIVEN IN R's LAST IW, GO TO G41a

G21. In R's LAST IW MONTH, YEAR our records indicate that your job title was R's LAST IW TITLE.

Is this still the case?

[IWER: IF JOB TITLE IS SLIGHTLY INACCURATE BUT DOES DESCRIBES R's CURRENT JOB, ANSWER "YES" HERE AND NOTE CORRECTIONS AS A COMMENT.]

1. YES	5. NO	7. DENIES HAVING THIS JOB TITLE AT PREVIOUS WAVE	8. DK	9. RF
GO TO G44	GO TO G41b BRANCHPOINT		GO TO G41b BRANCHPOINT	

G22. What was your job title in [CURRENT IW MONTH, 1996/R's LAST IW MONTH, YEAR]?

[IWER: PROBE]

The title that your employer used?

\_\_\_\_\_

DK	RF
----	----

TITLE

G23. What sort of work did you do?

[IWER: PROBE]

Tell me a little more about what you did.

\_\_\_\_\_  
\_\_\_\_\_  
\_\_\_\_\_  
\_\_\_\_\_  
\_\_\_\_\_

DK

RF

G24. What is your job title now?

[IWER: PROBE]

The title that your employer uses?

\_\_\_\_\_

DK

RF

TITLE

G25. What sort of work do you do now?

[IWER: PROBE]

Tell me a little more about what you do.

\_\_\_\_\_  
\_\_\_\_\_  
\_\_\_\_\_  
\_\_\_\_\_  
\_\_\_\_\_

DK

RF

G26 BRANCHPOINT: IF R DENIES HAVING PREVIOUSLY LISTED JOB TITLE AT R's LAST IW (G21=7), GO TO G43 BRANCHPOINT

G26. According to our records, you were working (for R's LAST IW EMPLOYER NAME) in R's LAST IW MONTH, YEAR.

In what month and year did you stop working for that employer?

[IWER: MONTHS ENTERED MUST BE BETWEEN R's LAST IW MONTH, YEAR AND CURRENT IW MONTH, YEAR]

MONTH:

01. JAN	02. FEB	03. MAR	04. APR	05. MAY
06. JUN	07. JUL	08. AUG	09. SEP	10. OCT
11. NOV	12. DEC	96. STILL WORKING FOR PREVIOUS WAVE EMPLOYER	98. DK	99. RF

\_\_\_\_\_  DK  RF

G26a. YEAR

G27. What were you earning, before deductions, when you left that employer?

[IWER: IF PER HOUR BE SURE TO ADD .00 FOR CENTS IF THERE ARE NONE]

[IWER: PROBE IF NECESSARY]

Was that per hour, week, month, or year?

\_\_\_\_\_  DK  RF

AMOUNT

**GO TO G28**

27a. PER:

01. HOUR	02. WEEK	03. EVERY TWO WEEKS/BI-WEEKLY	04. MONTH
06. YEAR	97. OTHER (SPECIFY) _____	98. DK	99. RF

G28. IF NOT SELF-EMPLOYED AT LAST IW:  
Why did you leave that employer?

(Did the business close, were you laid off or let go, did you leave to take care of family members, or what?)

IF SELF-EMPLOYED AT LAST IW:  
Why did you stop working at that business?

[IWER: DO NOT PROBE BUT CHOOSE ALL THAT APPLY]

01. BUSINESS CLOSED	02. LAID OFF/LET GO	03. POOR HEALTH/DISABLED	04. FAMILY CARE	05. BETTER JOB
GO TO G29 BRANCHPOINT	GO TO G28d			
06. QUIT	07. RETIRED	97. OTHER (SPECIFY) _____	98. DK	99. RF

G28a BRANCHPOINT: IF R WAS SELF-EMPLOYED AT R's LAST IW, GO TO G29 BRANCHPOINT

G28a. Did your employment situation change in some way that encouraged you to leave?

1. YES	5. NO	8. DK	9. RF
GO TO G28c			

G28b. How did it change?

[IWER: CHOOSE ALL THAT APPLY]

01. SUPERVISOR ENCOURAGED DEPARTURE	02. COWORKER ENCOURAGED DEPARTURE	03. WAGES REDUCED (OR ABOUT TO BE REDUCED)	04. HOURS REDUCED (OR ABOUT TO BE REDUCED)
			GO TO G28d
05. WOULD HAVE BEEN LAID OFF	06. NEW JOB DUTIES	07. NEW JOB LOCATION	08. BECAME ELIGIBLE FOR PENSION
09. EMPLOYER CHANGED HEALTH INSURANCE	10. SPECIAL EARLY RETIREMENT INCENTIVE OFFER		
97. OTHER (SPECIFY) _____	98. DK	99. RF	

G28c. If your employer had allowed you to work fewer hours with correspondingly less pay, would you have continued working there?

1. YES	5. NO	8. DK	9. RF
--------	-------	-------	-------

G28d. Did your employer experience a permanent reduction in employment between [CURRENT IW MONTH, 1996/R's LAST IW MONTH, YEAR] and the time you were leaving?

[IWER: PERMANENT EMPLOYMENT REDUCTIONS ARE SOMETIMES CALLED "DOWNSIZING"; "LAYOFFS" CAN BE PERMANENT OR TEMPORARY.]

1. YES	5. NO	8. DK	9. RF
--------	-------	-------	-------

G29 BRANCHPOINT IF R STOPPED WORKING FOR {LAST IW EMPLOYER or SELF} {ONE MONTH OR LESS} AFTER R's LAST IW (PER {G26/G26a or G5/G5a}) or R DID NOT SAY WHEN S/HE STOPPED WORKING FOR {LAST IW EMPLOYER or SELF} ({G26 or G26a}={DK or RF} or {G5 or G5a}={DK or RF}), GO TO G30

G29. Were there any months between R's LAST IW MONTH, YEAR and MONTH, YEAR R STOPPED WORKING FOR [EMPLOYER (per G26&G26a)/SELF (per G5&G5a)] when you did not work [at this business/for this employer]?

1. YES	5. NO	8. DK	9. RF
GO TO G30			

G29a. Which months were those?

[IWER: MONTHS ENTERED MUST BE BETWEEN R's LAST IW MONTH, YEAR AND MONTH, YEAR R STOPPED WORKING FOR [EMPLOYER (per G26&G26a)/SELF (per G5&G5a)]]

[IWER: CHOOSE ALL THAT APPLY]

01. JAN 96	02. FEB 96	03. MAR 96	04. APR 96	05. MAY 96	06. JUN 96	07. JUL 96
08. AUG 96	09. SEP 96	10. OCT 96	11. NOV 96	12. DEC 96	13. JAN 97	14. FEB 97
15. MAR 97	16. APR 97	17. MAY 97	18. JUN 97	19. JUL 97	20. AUG 97	21. SEP 97
22. OCT 97	23. NOV 97	24. DEC 97	25. JAN 98	26. FEB 98	27. MAR 98	28. APR 98
29. MAY 98	30. JUN 98	31. JUL 98	32. AUG 98	33. SEP 98	34. OCT 98	35. NOV 98
36. DEC 98	37. ALL OF 1996 (AFTER PREV IW)		38. ALL OF 1997		39. ALL OF 1998 TO DATE	
40. MONTHS PRIOR TO 1996 _____			97. OTHER (SPECIFY) _____		98. DK	99. RF

G30. (Aside from IRAs or KEOGH plans,) Were you included in a pension or retirement plan, or in any tax deferred savings plan, [when you worked for that employer/through your work]?

1. YES	5. NO	8. DK	9. RF
GO TO G39 BRANCHPOINT			



G31. I would like to know what type of plan this was. In some retirement plans, Type A, benefits are usually based on a formula involving age, years of service, and salary. In other plans, Type B, money is accumulated in an account for you.

Was your plan Type A or Type B?

DEFINITION: 401-K, 403-B, ESOP, SRA, THRIFT/SAVINGS, STOCK/PROFIT SHARING, MONEY PURCHASE PLANS ARE ALL TYPE B RETIREMENT PLANS. TYPE A PLANS ARE OFTEN CALLED "DEFINED BENEFIT" PLANS; TYPE B PLANS ARE OFTEN CALLED "DEFINED CONTRIBUTION."

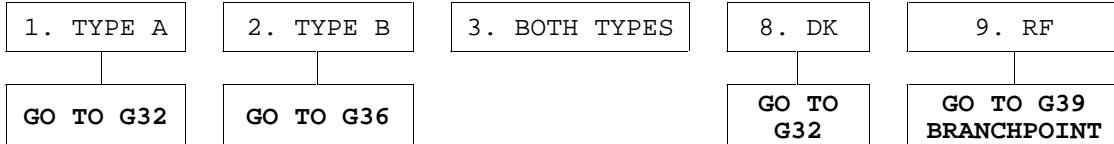

G31a. For the part of your pension where money is accumulated in an account, how much money was in your account when you left that [business/employer]?

\_\_\_\_\_

AMOUNT

DK	RF
----	----

G31b. When you left that [business/employer], did you withdraw the money, roll it over into an IRA, leave it to accumulate in the old plan, convert it to an annuity, or what?

[IWER: DO NOT PROBE, BUT IF MORE THAN ONE RESPONSE GIVEN, CHOOSE 7 - OTHER, AND RECORD ALL DETAILS.]

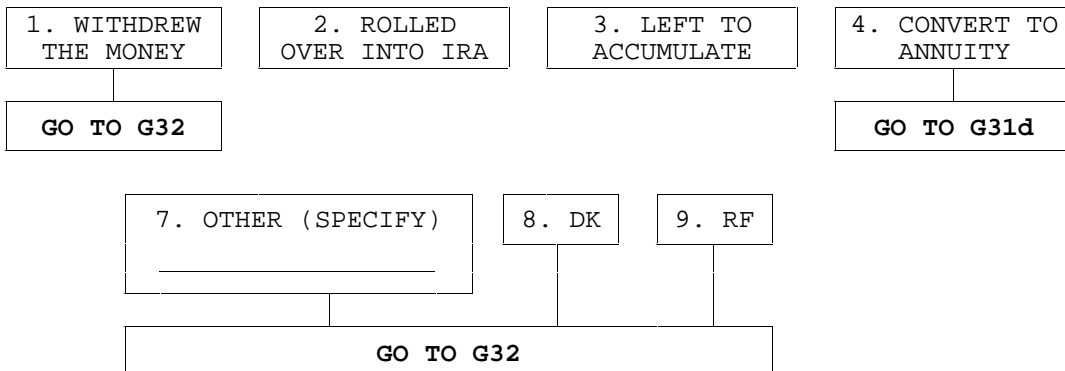

G31c. How much is in your account now?

\_\_\_\_\_

AMOUNT

DK	RF
GO TO G32	

G31d. How old were you when you started receiving the benefits from that annuity?

[IWER: IF R INDICATES BENEFITS HAVE NOT YET STARTED, ASK AT WHAT AGE THEY WILL BEGIN, AND NOTE THIS IN COMMENT BOX.]

\_\_\_\_\_

AGE

DK

RF

G31e. How much are the benefits per month or year?

[IWER: PROBE IF NECESSARY]  
Was that per month or year?

[IWER: IF BENEFITS HAVE NOT YET STARTED, RECORD WHAT BENEFITS WILL BE.]

\_\_\_\_\_

AMOUNT

DK

RF

**GO TO G32**

G31f. PER:

01. HOUR	02. WEEK	03. EVERY TWO WEEKS/BI-WEEKLY	04. MONTH
06. YEAR	97. OTHER (SPECIFY) _____	98. DK	99. RF

G32. IF R's PLAN IS BOTH TYPE A AND TYPE B (G31=3):  
(Now, about the part of your pension where benefits are based on a formula.)

ASK OF ALL:  
Do you expect to receive benefits from this plan in the future, are you receiving benefits now, did you get a cash settlement when you left, did you lose your benefits, or what?

[IWER: DO NOT PROBE BUT CHOOSE ALL THAT APPLY AND ASK ALL APPROPRIATE FOLLOW-UP QUESTIONS.]

1. EXPECT FUTURE BENEFITS	2. RECEIVING BENEFITS NOW	3. RECEIVED CASH SETTLEMENT	4. ROLLED OVER INTO IRA
5. LOST BENEFITS	7. OTHER (SPECIFY) _____	8. DK	9. RF

G32a BRANCHPOINT: IF R DID NOT REPORT THAT IS RECEIVING BENEFITS NOW (G32 NOT 2), GO TO G32g BRANCHPOINT

G32a. In what month and year did you start to receive these benefits?

MONTH:

01. JAN	02. FEB	03. MAR	04. APR	05. MAY
06. JUN	07. JUL	08. AUG	09. SEP	10. OCT
11. NOV	12. DEC	98. DK	99. RF	

\_\_\_\_\_  DK  RF

G32b. YEAR

G32c. How much are the benefits per month or year?

[IWER: PROBE IF NECESSARY]  
Was that per month or year?

\_\_\_\_\_  DK  RF

AMOUNT

**GO TO G32e**

G32d. PER:

01. HOUR	02. WEEK	03. EVERY TWO WEEKS/BI-WEEKLY	04. MONTH
06. YEAR	97. OTHER (SPECIFY)	98. DK	99. RF

G32e. Are the benefits adjusted for changes in the cost of living?

1. YES	5. NO	8. DK	9. RF
--------	-------	-------	-------

**GO TO G38**

G32g BRANCHPOINT: IF R DID NOT REPORT THAT RECEIVED A CASH SETTLEMENT WHEN LEFT JOB (G32 NOT 3), GO TO G32j BRANCHPOINT

G32g. How much did the cash settlement amount to?

\_\_\_\_\_  DK  RF

AMOUNT

G32h. What did you do with the money?

1. BOUGHT DURABLES	2. SPENT IT	3. SAVED/INVESTED	4. PAID OFF DEBT
5. ROLLED INTO IRA	7. OTHER (SPECIFY) _____		8. DK
			9. RF

G32j BRANCHPOINT: IF R DID NOT REPORT THAT ROLLED PENSION OVER INTO IRA WHEN LEFT JOB (G32 NOT 4), GO TO G34

G32j. How much did the rollover amount to?

\_\_\_\_\_

AMOUNT

DK	RF
----	----

G34 BRANCHPOINT: IF R DID NOT REPORT THAT EXPECTS FUTURE BENEFITS FROM PENSION FROM FORMER JOB (G32 NOT 1), GO TO G38

G34. At what age do you expect to start receiving (the rest of your) benefits from this plan?

\_\_\_\_\_

AGE

96. ALREADY RECEIVING ALL BENEFITS	DK	RF
GO TO G38		

G35. About how much do you expect these benefits to be? As a proportion of your pay when you left that job, or as an amount per month or year when you start receiving them?

1. PERCENT OF PAY	2. AMOUNT PER MONTH/YEAR	3. LUMP SUM	8. DK	9. RF
GO TO G35b		GO TO G35d	GO TO G38	

G35a. ENTER THE PERCENT OF FINAL PAY:

\_\_\_\_\_

PERCENT

DK	RF
GO TO G38	

G35b. [IWER: PROBE IF NECESSARY]  
How much do you expect to receive?

[IWER: PROBE IF NECESSARY]  
Was that per month or year?

\_\_\_\_\_

AMOUNT

DK	RF
----	----

GO TO G38

G35c. PER:

01. HOUR	02. WEEK	03. EVERY TWO WEEKS/BI-WEEKLY	04. MONTH
----------	----------	----------------------------------	-----------

GO TO G38

06. YEAR	97. OTHER (SPECIFY)	98. DK	99. RF
----------	---------------------	--------	--------

GO TO G38

G35d. ENTER LUMP SUM AMOUNT:

\_\_\_\_\_

AMOUNT

DK	RF
----	----

GO TO G38

G36. How much money was in your account when you left that  
[business/employer]?

\_\_\_\_\_

AMOUNT

DK	RF
----	----

G37. When you left that [business/employer], did you withdraw the money, roll it over into an IRA, leave it to accumulate in your old plan, convert it to an annuity, or what?

[IWER: DO NOT PROBE, BUT IF MORE THAN ONE RESPONSE GIVEN, CHOOSE 7 - OTHER, AND RECORD ALL DETAILS.]

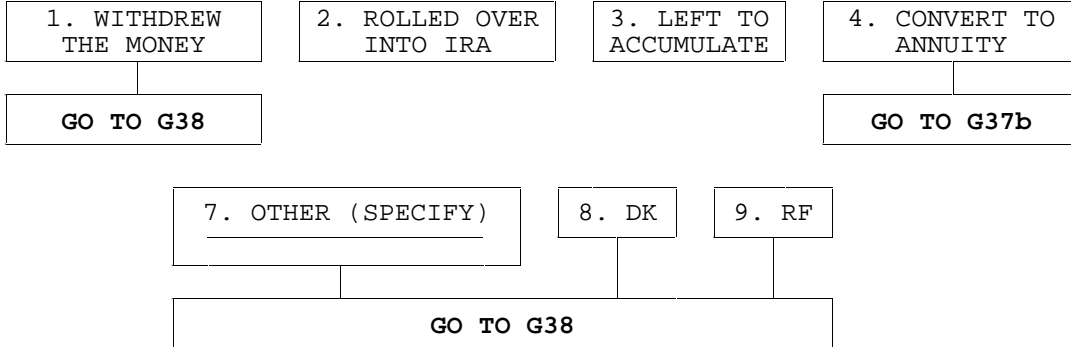

G37a. How much is in your account now?

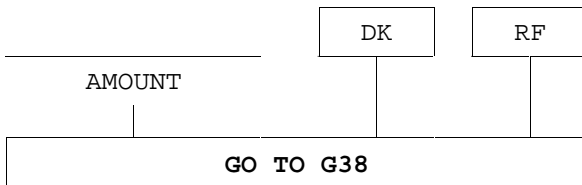

G37b. How old were you when you started receiving the benefits from that annuity?

[IWER: IF R INDICATES BENEFITS HAVE NOT YET STARTED, ASK AT WHAT AGE THEY WILL BEGIN, AND NOTE THIS IN COMMENT BOX.]

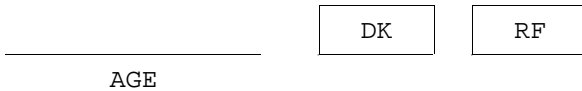

G37c. How much are the benefits per month or year?

[IWER: PROBE IF NECESSARY]  
Was that per month or year?

[IWER: IF BENEFITS HAVE NOT YET STARTED, RECORD WHAT BENEFITS WILL BE.]

\_\_\_\_\_

AMOUNT

DK	RF
GO TO G38	

G37d. PER:

01. HOUR	02. WEEK	03. EVERY TWO WEEKS/BI-WEEKLY	04. MONTH
06. YEAR	97. OTHER (SPECIFY) _____	98. DK	99. RF

G38. What is the earliest age at which you could have left that [business/employer] and begun to receive pension benefits?

\_\_\_\_\_

AGE

95. NO AGE REQUIREMENT	DK	RF
------------------------	----	----

G39 BRANCHPOINT: IF R DID NOT REPORT THAT IS CURRENTLY WORKING (G2 NOT 1), GO TO G115

IF R IS CURRENTLY SELF-EMPLOYED (G3=2), GO TO G41a

G39. READ TO ALL RESPONDENTS:  
We would like to obtain complete information about fringe benefits for employees like you. In order to do this, we need the full name and address of your employer.

For whom do you work [now/on your main job]?

(What is the [company's/organization's] name?)

\_\_\_\_\_

COMPANY

DK	RF
GO TO G41a	

G40. What is the address of the place where you work?

[IWER: PROBE IF NECESSARY]

I will need the mailing address, city, state, and zip code.

	DK	RF
G40a. ADDRESS		 GO TO G41a
	DK	RF
G40b. CITY		 GO TO G41a
	DK	RF
G40c. STATE		 GO TO G41a
	DK	RF
G40d. ZIP		

[IWER: DO NOT USE DASH IN PHONE NUMBER ENTER 999 FOR UNKNOWN AREA CODE]

	DK	RF
G40e. PHONE NUMBER		

G41a. IF NOT SELF-EMPLOYED:

What kind of business or industry do you work in--that is, what do they make or do at the place where you work?

IF SELF-EMPLOYED:

Now I have a few questions about your current business.

What industry do you work in? That is, what does your company do or make?

(What industry do you typically work in?)

	DK	RF
INDUSTRY		

G41b BRANCHPOINT: IF R IS CURRENTLY SELF-EMPLOYED (G3=2), GO TO G42





G45. Do you work [the same/this] number of hours nearly every week, or do the hours you work vary a lot from week to week?

IF VARIATION IS DUE TO NOT WORKING AT ALL IN SOME WEEKS: PROBE —  
These questions are about times when you are working.

1. SAME EACH WEEK/THIS NUMBER	2. VARY A LOT	8. DK	9. RF
GO TO G46		GO TO G46	

G45a. How many hours would you work in a week with relatively long hours?

1 - 95 HOURS

\_\_\_\_\_

HOURS

DK	RF
----	----

G45b. How many hours in a relatively short week?

0 - 95 HOURS

\_\_\_\_\_

HOURS

DK	RF
----	----

G46. How many weeks of paid vacation do you get each year?

\_\_\_\_\_

AMOUNT

DK	RF
ASSIGN 6 TO G46b AND GO TO G47	

G46b. TIME UNIT:

1. DAYS	2. WEEKS	4. MONTHS	6. NONE
7. OTHER (SPECIFY) _____		8. DK	9. RF

G47. READ SLOWLY:  
(Counting paid vacations as weeks of work,) How many weeks a year do you usually work on this job?

[IWER: COUNT PAID SICK TIME AS WORK TIME]

\_\_\_\_\_

WEEKS

DK	RF
----	----

G48. In the last 12 months, did you miss any days from work because of your health?

1. YES	5. NO	8. DK	9. RF
GO TO G49 BRANCHPOINT			

G48a. About how many days did you miss?

\_\_\_\_\_

DAYS

DK	RF
----	----

G49 BRANCHPOINT: IF R HAS SAME {EMPLOYER AND JOB TITLE} AS R's LAST IW (G21=1), GO TO G56

IF R IS CURRENTLY SELF-EMPLOYED (G3=2), GO TO G52

G49. How many days of paid sick leave at full pay do you earn each year?

\_\_\_\_\_

DAYS

995. NO SET NUMBER	DK	RF
--------------------	----	----

G50. Does your employer provide coverage for long-term disability on this job?

1. YES	5. NO	8. DK	9. RF
--------	-------	-------	-------

G51. On your job, do you make decisions about the pay and promotion of others?

1. YES	5. NO	8. DK	9. RF
GO TO G56			

G51a. For how many people do you make pay and promotion decisions?

\_\_\_\_\_

NUMBER OF PEOPLE

DK	RF
GO TO G56	

G52. Are you paid a regular salary or wages?

1. YES	5. NO	8. DK	9. RF
--------	-------	-------	-------

GO TO G53

G52a. How much are you paid before taxes and other deductions?

[IWER: IF PER HOUR BE SURE TO ADD .00 FOR CENTS IF THERE ARE NONE]

[IWER: USE ZERO FOR NONE]

_____	DK	RF
AMOUNT		

GO TO G53

G52b. PER:

01. HOUR	02. WEEK	03. EVERY TWO WEEKS/BI-WEEKLY	04. MONTH
06. YEAR	97. OTHER (SPECIFY) _____	98. DK	99. RF

G53. Do you receive some or all of the net earnings or profits?

1. YES	5. NO	8. DK	9. RF
--------	-------	-------	-------

GO TO G54

G53a. (In addition to your regular salary,) How much do you receive from net earnings or profits?

IF R HAS TROUBLE GIVING DOLLAR FIGURE, ASK:  
What did you earn the last year you worked?

[IWER: IF PER HOUR BE SURE TO ADD .00 FOR CENTS IF THERE ARE NONE]

[IWER: USE ZERO FOR NONE]

\_\_\_\_\_

AMOUNT

DK	RF
GO TO G54	

G53b. PER:

01. HOUR	02. WEEK	03. EVERY TWO WEEKS/BI-WEEKLY	04. MONTH
06. YEAR	97. OTHER (SPECIFY) _____	98. DK	99. RF

G54. Including yourself, how many people work in this business?

\_\_\_\_\_

NUMBER OF PEOPLE

DK	RF
----	----

G55a BRANCHPOINT: IF {R HAS SAME SPOUSE/PARTNER AS R's LAST IW and R WAS SELF-EMPLOYED AT R's LAST IW} or R IS NOT MARRIED/PARTNERED, GO TO G63

G55a. Does your [husband/wife/partner] do any work for the business?

1. YES	5. NO	8. DK	9. RF
GO TO G63			

G55b. How many hours a week does [he/she] usually work for the business?

\_\_\_\_\_

NUMBER OF HOURS

DK	RF
----	----

G55c. Is [he/she] paid a regular salary?

1. YES	5. NO	8. DK	9. RF
GO TO G63			

G56. Are you salaried on this job, paid by the hour, or what?

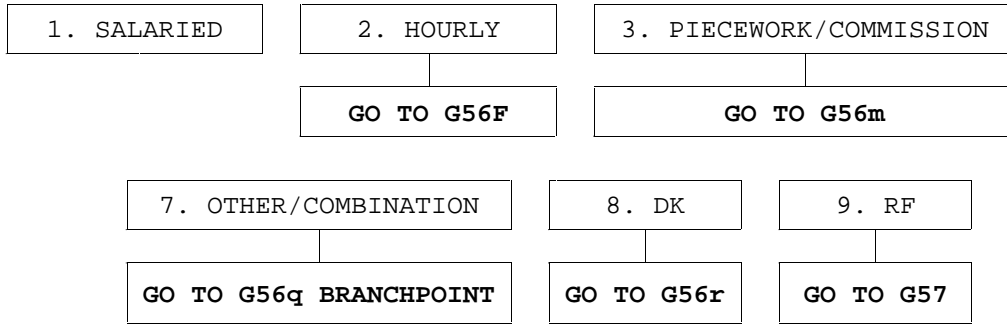

G56a. How much is your salary, before taxes and other deductions?

[IWER: IF PER HOUR BE SURE TO ADD .00 FOR CENTS IF THERE ARE NONE]

[IWER: PROBE IF NECESSARY]

Is that per hour, week, month, or year?

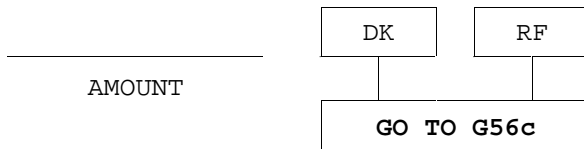

G56b. PER:

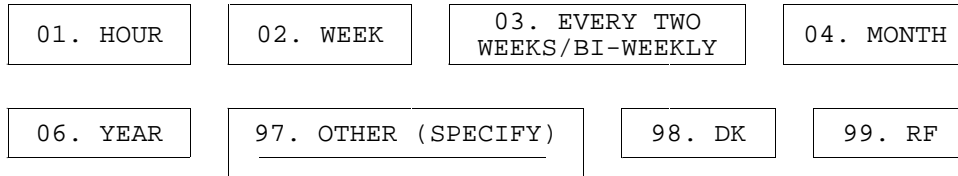

G56c. If you were to work more hours than usual during some weeks, would you get paid for those extra hours, get time off later, or get no compensation for the extra hours?

[IWER: IF TREATMENT OF OVERTIME DIFFERS (E.G., DEPENDING ON DAY OF WEEK) PROBE FOR MOST FREQUENT OR MOST IMPORTANT OUTCOME.]

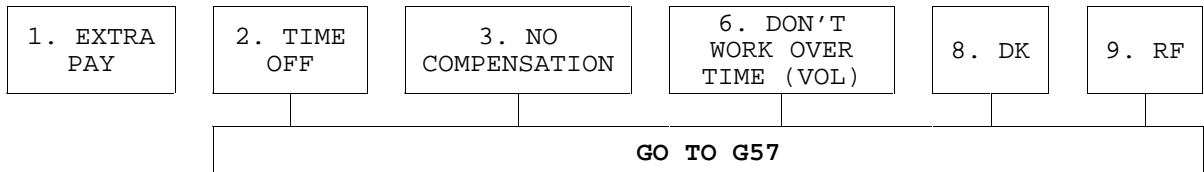

G56d. About how much would you make per hour for those extra hours?

1. TIME AND HALF	2. DOUBLE TIME	3. STRAIGHT TIME OR REGULAR WAGE
GO TO G57		

4. PER HOUR AMOUNT	7. OTHER (SPECIFY) _____	8. DK	9. RF
GO TO G57			

G56e. [IWER: PROBE IF NECESSARY]

How much would you make per hour for each extra hour?

[IWER: BE SURE TO ENTER .00 FOR CENTS IF THERE ARE NONE]

AMOUNT _____	DK	RF
GO TO G57		

G56f. What is your hourly wage rate for regular work time?

[IWER: IF PER HOUR BE SURE TO ADD .00 FOR CENTS IF THERE ARE NONE]

AMOUNT _____	DK	RF
GO TO G57		

G56g. What is your hourly wage rate for overtime?

[IWER: IF TREATMENT OF OVERTIME DIFFERS (E.G., DEPENDING ON DAY OF WEEK) PROBE FOR MOST FREQUENT OR MOST IMPORTANT OUTCOME.]

1. TIME AND A HALF	2. DOUBLE TIME	3. STRAIGHT TIME OR REGULAR WAGE	4. AMOUNT PER HOUR
GO TO G56j			

5. GET TIME OFF	6. DON'T WORK OVERTIME	7. OTHER (SPECIFY) _____	8. DK	9. RF
GO TO G56j	GO TO G57	GO TO G56j		

G56g-2. (What is your hourly wage rate for overtime?)

[IWER: BE SURE TO ADD .00 FOR CENTS IF THERE ARE NONE]

_____	NONE	DK	RF
AMOUNT			
GO TO G57			

G56j. During the last year, in how many weeks did you work some overtime?

_____	0	DK	RF
WEEKS			
GO TO G57			

G56k. Are you required to work overtime, or it is pretty much up to you?

1. REQUIRED	2. SOMETIMES REQUIRED	3. UP TO R	8. DK	9. RF
GO TO G57				

G56m. What does that amount to, before taxes and other deductions, in an average week or month?

[IWER: PROBE IF NECESSARY]  
Was that per week or month?

_____	DK	RF
AMOUNT		
GO TO G57		

G56n. PER:

01. HOUR	02. WEEK	03. EVERY TWO WEEKS/BI-WEEKLY	04. MONTH
06. YEAR	97. OTHER (SPECIFY) _____	98. DK	99. RF

G56p. If you worked an extra hour, how much would you earn for that?

[IWER: BE SURE TO ADD .00 FOR CENTS IF THERE ARE NONE]

_____	0. NO EXTRA PAY OR TIME OFF	999995. GET TIME OFF INSTEAD	DK	RF
AMOUNT				



G56q BRANCHPOINT: IF R IS WORKING NOW FOR PAY (WAS ASKED G56) and DID NOT ANSWER 'OTHER/COMBINATION' TO HOW S/HE IS PAID (G56 NOT 7), GO TO G57

G56q. How are you paid?

\_\_\_\_\_

HOW PAID

DK

RF

G56r. How much are you paid before taxes and other deductions?

[IWER: IF PER HOUR BE SURE TO ADD .00 FOR CENTS IF THERE ARE NONE]

[IWER: PROBE IF NECESSARY]

Was that per hour, week, month, or year?

\_\_\_\_\_

AMOUNT

DK

RF

GO TO G57

G56s. PER:

01. HOUR	02. WEEK	03. EVERY TWO WEEKS/BI-WEEKLY	04. MONTH
06. YEAR	97. OTHER (SPECIFY) _____	98. DK	99. RF

G56t. If you worked an extra hour, how much would you earn for that hour?

[IWER: IF PER HOUR BE SURE TO ADD .00 FOR CENTS IF THERE ARE NONE]

\_\_\_\_\_

AMOUNT

0. NO EXTRA PAY OR TIME OFF	99995. GET TIME OFF INSTEAD	DK	RF
--------------------------------	--------------------------------	----	----

G57. (Not counting overtime hours), Could you reduce the number of paid hours in your regular work schedule?

1. YES	5. NO	8. DK	9. RF
--------	-------	-------	-------

G57a BRANCHPOINT: IF R IS ABLE TO REDUCE WORK HOURS (G57=1) and R WORKS {30 OR MORE} HOURS PER WEEK (G44 ≥ 30), GO TO G59

IF R IS ABLE TO REDUCE WORK HOURS (G57=1) and R DID NOT REPORT WORKING AT LEAST 30 HOURS PER WEEK (G44 {<30 or = {DK or RF}}), GO TO G60

G57a. Would you like to do so even if your earnings were reduced in the same proportion?

1. YES	5. NO	8. DK	9. RF
GO TO G60			

G57b. How many hours would you like to work each week?

_____	DK	RF
NUMBER OF HOURS		
GO TO G60		

G59. If you wanted to work half time or less on this job, would your employer allow you to do that?

1. YES	3. ONLY TEMPORARILY	5. NO	8. DK	9. RF
GO TO G60				

G59a. Would your pay be cut in proportion to your hours, more than that, or less than that?

1. IN PROPORTION	2. MORE	3. LESS	8. DK	9. RF
------------------	---------	---------	-------	-------

G59b. Would your health insurance benefits be reduced, eliminated, or kept the same?

1. REDUCED	2. ELIMINATED	3. KEPT THE SAME
6. DOESN'T HAVE HEALTH INSURANCE BENEFITS	8. DK	9. RF

G59c. Would your eligibility for pension benefits be affected?

1. YES	5. NO	6. DOESN'T HAVE PENSION BENEFITS	8. DK	9. RF
--------	-------	----------------------------------	-------	-------

G60. Could you increase the number of paid hours in your regular work schedule?

1. YES	5. NO	8. DK	9. RF
GO TO G61 BRANCHPOINT			

G60a. Would you like to do so if your earnings were increased in the same proportion?

1. YES	5. NO	8. DK	9. RF
--------	-------	-------	-------

GO TO G61 BRANCHPOINT

G60b. How many hours would you like to work each week?

\_\_\_\_\_

DK	RF
----	----

NUMBER OF HOURS

G61 BRANCHPOINT: IF R DID NOT REPORT WORKING FOR SAME EMPLOYER AS IN R's LAST IW ({G19a or G19b} NOT 1), GO TO G61

IF R WORKS FOR SAME EMPLOYER AS IN R's LAST IW ({G19a or G19b}=1) and DOES NOT REPORT HAVING THE SAME JOB TITLE (G21 NOT 1), GO TO G65b BRANCHPOINT

OTHERWISE, GO TO G65b BRANCHPOINT

G61. About how many employees work for this company or organization at the location where you work?

\_\_\_\_\_

DK	RF
----	----

NUMBER OF EMPLOYEES

GO TO G62

G61a. Is it fewer than 5, 5 to 14, 15 to 24, 25 to 99, 100 to 499, or 500 or more?

1. FEWER THAN 5	2. 5 TO 14	3. 15 TO 24	4. 25 TO 99
5. 100 TO 499	6. 500 OR MORE	8. DK	9. RF

G62. About how many employees work for this company or organization at all locations?

[IWER: THE NUMBER MUST BE AT LEAST AS LARGE AS G61]

[IWER: DON'T PROBE "DON'T KNOW"]

[IWER: ENTER "99995" IF ONLY ONE LOCATION]

\_\_\_\_\_

	DK	RF
--	----	----

NUMBER OF EMPLOYEES

|

GO TO G63

G62a BRANCHPOINT: IF AT LEAST 500 EMPLOYEES WORK AT R'S LOCATION (G61≥500 or G61a=6) or R REPORTED HOW MANY WORK AT ALL COMPANY LOCATIONS (G62 {NOT DK and NOT RF}), GO TO G63

G62a. Is it fewer than 5, 5 to 14, 15 to 24, 25 to 99, 100 to 499, or 500 or more?

1. FEWER THAN 5	2. 5 TO 14	3. 15 TO 24	4. 25 TO 99
5. 100 TO 499	6. 500 OR MORE	8. DK	9. RF

G63. In what month and year did you start working for [this business/this employer]?

[IWER: IF R WORKED MORE THAN ONCE FOR THIS EMPLOYER, ASK ABOUT FIRST HIRE.]

IF THIS IS A REINTERVIEW R AND SECOND R:  
 [IWER: IF DATE GIVEN IS BEFORE R'S LAST IW MONTH, YEAR, PLEASE VERIFY WITH R]

MONTH:

01. JAN	02. FEB	03. MAR	04. APR	05. MAY
06. JUN	07. JUL	08. AUG	09. SEP	10. OCT
11. NOV	12. DEC	98. DK	99. RF	

\_\_\_\_\_

DK	RF
----	----

G63a. YEAR

G65 BRANCHPOINT: IF NEW INTERVIEW R, GO TO G65b BRANCHPOINT

IF R STARTED WORKING FOR CURRENT EMPLOYER LESS THAN 2 MONTHS FROM {MONTH AND YEAR} OF CURRENT IW (PER G63/G63a) or WE DON'T KNOW BOTH (MONTH and YEAR) WHEN R STARTED CURRENT JOB ({G63 or G63a}={DK or RF}), GO TO G65b BRANCHPOINT

G65. Were there any months since [MONTH, YEAR R STARTED CURRENT JOB/R's LAST IW MONTH, YEAR/in the last two years] when you did not work for this [business/employer]?

1. YES	5. NO	8. DK	9. RF
GO TO G65b BRANCHPOINT			

G65a. Which months were those?

[IWER: MONTHS ENTERED MUST BE [MONTH, YEAR R STARTED CURRENT JOB/R's LAST IW MONTH, YEAR/CURRENT IW MONTH, 1996] AND CURRENT IW MONTH, YEAR.]

[IWER: CHOOSE ALL THAT APPLY]

01. JAN 96	02. FEB 96	03. MAR 96	04. APR 96	05. MAY 96	06. JUN 96	07. JUL 96
08. AUG 96	09. SEP 96	10. OCT 96	11. NOV 96	12. DEC 96	13. JAN 97	14. FEB 97
15. MAR 97	16. APR 97	17. MAY 97	18. JUN 97	19. JUL 97	20. AUG 97	21. SEP 97
22. OCT 97	23. NOV 97	24. DEC 97	25. JAN 98	26. FEB 98	27. MAR 98	28. APR 98
29. MAY 98	30. JUN 98	31. JUL 98	32. AUG 98	33. SEP 98	34. OCT 98	35. NOV 98
36. DEC 98	37. ALL OF 1996 (AFTER PREV IW)		38. ALL OF 1997		39. ALL OF 1998 TO DATE	
40. MONTHS PRIOR TO 1996 _____			97. OTHER (SPECIFY) _____		98. DK	99. RF

G65b BRANCHPOINT: IF R IS CURRENTLY SELF-EMPLOYED (G3=2), GO TO G67 BRANCHPOINT



\*\*\*BEGINNING OF G69 LOOP: QUESTIONS G69 THROUGH G74d ARE REPEATED FOR UP TO THREE PENSION PLANS.\*\*\*

G69. IF ONLY ONE PLAN:  
I would like to know what type of plan this is.

IF MORE THAN ONE PLAN:  
Now I have some questions about the (next) most important of these plans.

In some retirement plans, Type A, benefits are usually based on a formula involving age, years of service and salary. In other plans, Type B, money is accumulated in an account for you.

Is your plan Type A or Type B?

DEFINITION: 401-K, 403-B, ESOP, SRA, THRIFT/SAVINGS, STOCK/PROFIT SHARING, MONEY PURCHASE PLANS ARE ALL TYPE B RETIREMENT PLANS. TYPE A PLANS ARE OFTEN CALLED "DEFINED BENEFIT" PLANS; TYPE B PLANS ARE OFTEN CALLED "DEFINED CONTRIBUTION."

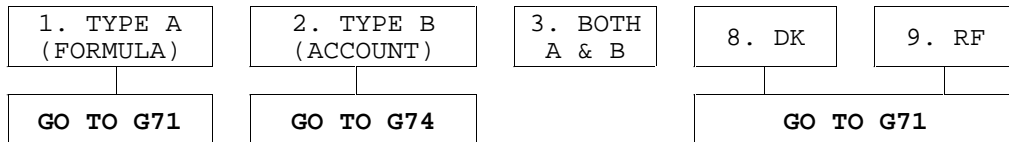

G70. For that part of your plan where money is accumulated in an account, how much is in the account at present?

\_\_\_\_\_

AMOUNT

DK	RF
----	----

G70a. Have you begun receiving benefits from this part of your pension?

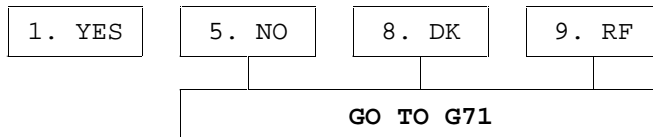

G70b/c. How much are you receiving?

\_\_\_\_\_

AMOUNT

DK	RF
----	----

GO TO G71

G70c. PER:

01. HOUR	02. WEEK	03. EVERY TWO WEEKS/BI-WEEKLY	04. MONTH
06. YEAR	97. OTHER (SPECIFY)	98. DK	99. RF

G71. (Now, about the part of your pension where benefits are based on a formula.)

At what age do you expect to start receiving benefits from this plan?

\_\_\_\_\_

AGE

96. ANSWERED IN YEARS	97. RECEIVING BENEFITS NOW	DK	RF
-----------------------	----------------------------	----	----

GO TO G72

GO TO G72

GO TO END OF G69 LOOP (AFTER G74d)

G71a. [IWER: "Expected age to start receiving benefits" IN YEARS]

\_\_\_\_\_

AGE

DK	RF
----	----

G72. About how much [are you receiving/do you expect your benefits to be]?

(As a percent of your pay at retirement, or as an amount per month or year?)

1. PERCENT OF PAY	2. AMOUNT PER MONTH/YEAR	3. LUMP SUM	8. DK	9. RF
-------------------	--------------------------	-------------	-------	-------

GO TO G72b

GO TO G72d

GO TO G73 BRANCHPOINT

G72a. [IWER: ENTER THE PERCENT OF FINAL PAY AT RETIREMENT]

\_\_\_\_\_

PERCENT

DK	RF
----	----

GO TO G73 BRANCHPOINT



G72b. [IWER: PROBE IF NECESSARY]  
 How much [are you receiving/do you expect to receive]?

[IWER: PROBE IF NECESSARY]  
 Was that per month or year?

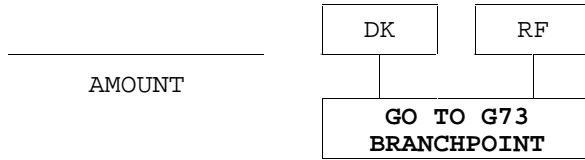

G72c. PER:

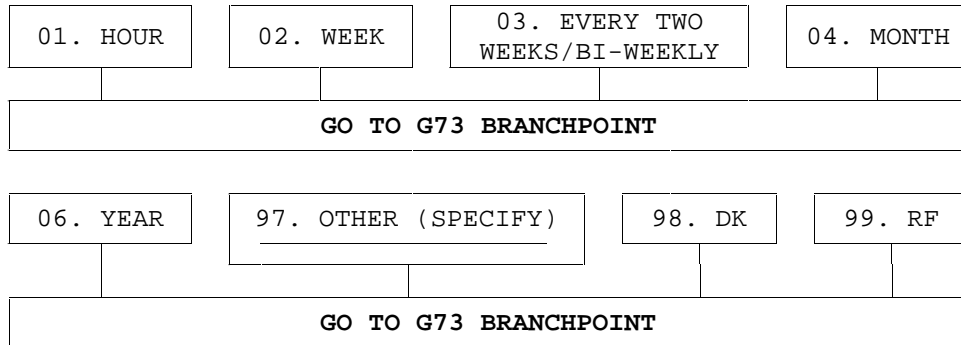

G72d. LUMP SUM AMOUNT:

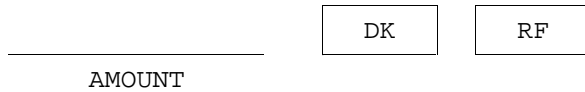

G73 BRANCHPOINT: IF R IS RECEIVING BENEFITS NOW (G71=97) or R DID NOT GIVE AGE THAT S/HE EXPECTS TO RECEIVE BENEFITS (G71={DK or RF}) or IF THIS IS THE {SECOND OR THIRD} PLAN, GO TO END OF G69 LOOP (AFTER G74d)

G73. If you work [at this business/with this employer] [until *AGE EXPECT BENEFITS (G71)*/for *YEARS EXPECT BENEFITS (G71a)*], how much do you expect your pay to be?

[IWER: IF PER HOUR BE SURE TO ADD .00 FOR CENTS IF THERE ARE NONE]

[IWER: PROBE IF NECESSARY]

Was that per hour, week, month, or year?

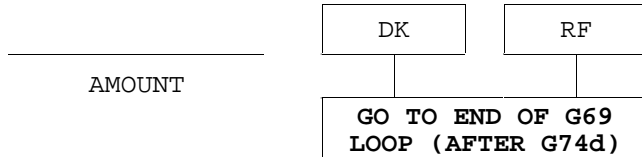

G73a. PER:

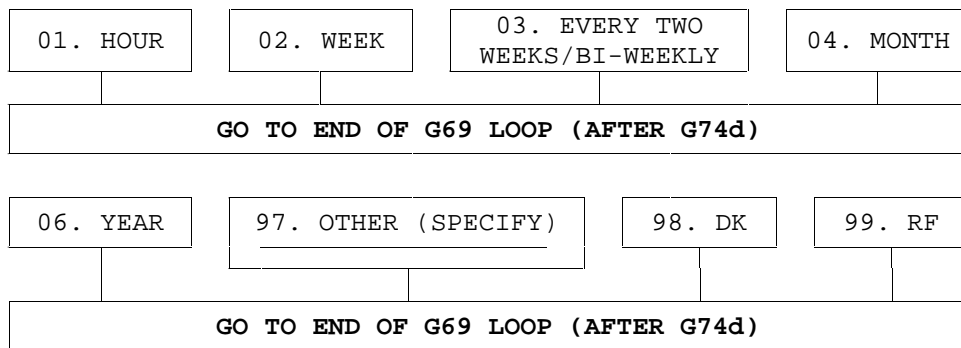

G74. How much money is in your account at present?

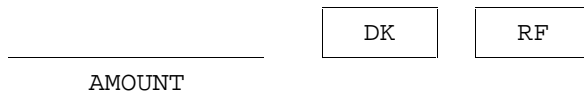

G74b. Are you currently receiving benefits from this plan?

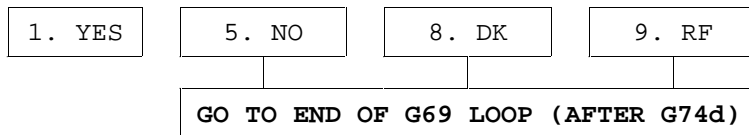

G74c/d. How much are you receiving?

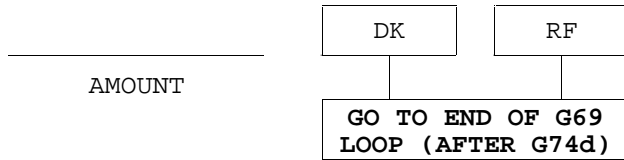

G74d. PER:

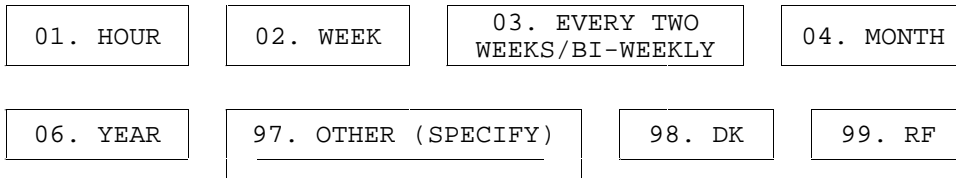

\*\*\*END OF G69 LOOP: IF THERE ARE MORE PENSION PLANS GIVEN, REPEAT QUESTIONS G69 THROUGH G74d FOR UP TO THREE PENSION PLANS. IF NOT, CONTINUE ON TO G75.\*\*\*

G75. IF NOT SELF-EMPLOYED:

Now I'd like to ask about pension or retirement plans on your job, sponsored by your employer or union. This includes not only basic pension or retirement plans, but also tax-deferred plans like thrift, savings, 401k, deferred profit-sharing, or stock ownership plans.

Are you included in any such pension, retirement, or tax-deferred plan with this employer?

IF SELF-EMPLOYED:

Now I'd like to ask about pension or retirement plans on your job. Aside from IRA or KEOGH plans, are you included in any pension plans or tax-deferred savings plans through your work?

[IWER: IF R MENTIONS IRA OR KEOGH PLANS, NOTE IN COMMENT BOX AND SAY:]  
 "We will ask about these later in the interview. Here, I just want to find out about other plans operated through your [employer/business]."

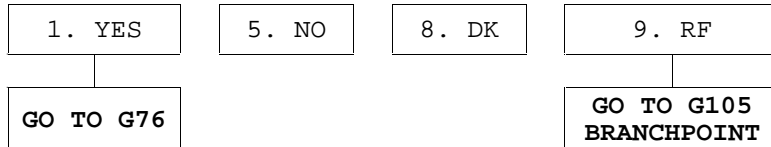

G75a BRANCHPOINT: IF R IS CURRENTLY SELF-EMPLOYED (G3=2), GO TO G105 BRANCHPOINT

G75a. Does your employer offer any such plans?

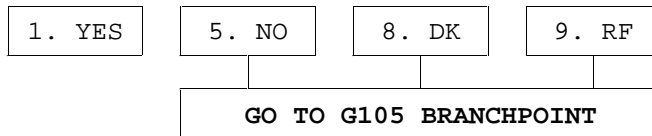

G75b. Are you eligible to be included in any of these plans?

1. YES	5. NO	6. ELIGIBLE IF WORKED FULL-TIME	8. DK	9. RF
GO TO G105 BRANCHPOINT				

G75c BRANCHPOINT: IF R IS STILL WORKING FOR SAME EMPLOYER AS R'S LAST IW ({G19a or G19b}=1), GO TO G105 BRANCHPOINT

IF R IS NOT ELIGIBLE TO BE INCLUDED IN JOB'S RETIREMENT PLANS (G75b=5), GO TO G75e

G75c. Does your employer make contributions to any such plans?

1. YES	5. NO	8. DK	9. RF
--------	-------	-------	-------

G75d. Do you intend to participate in any such plan at some time in the future?

1. YES	5. NO	8. DK	9. RF
GO TO G105 BRANCHPOINT			

G75e. Will you be eligible if you continue to work for this employer?

1. YES	3. DEPENDS (SPECIFY) _____	5. NO	8. DK	9. RF
GO TO G105 BRANCHPOINT				

G75f. How many more years will you have to work for this employer before you will be included in a pension plan?

_____	DK	RF
YEARS		
GO TO G105 BRANCHPOINT		

G76. In how many different plans of this sort are you included on this job?

_____	DK	RF
PLANS		
GO TO G105 BRANCHPOINT		

\*\*\*BEGINNING OF G77 LOOP: QUESTIONS G77 THROUGH G101c ARE ASKED FOR UP TO THREE PENSION PLANS.\*\*\*

G77. IF THIS IS THE FIRST PLAN AND R HAS MORE THAN ONE PLAN (G76≥2):  
Now I have some questions about the (next) most important of these plans. I would like to know what type of plan this is.

IF R HAS ONE PLAN (G76=1):  
I would like to know what type of plan this is.

OTHERWISE:  
Now I have some questions about the (next) most important of these plans.

(In some retirement plans, Type A, benefits are usually based on a formula involving age, years of service and salary. In other plans, Type B, money is accumulated in an account for you.)

Is your plan Type A or Type B?

DEFINITION: 401-K, 403-B, ESOP, SRA, THRIFT/SAVINGS, STOCK/PROFIT SHARING, MONEY PURCHASE PLANS ARE ALL TYPE B RETIREMENT PLANS. TYPE A PLANS ARE OFTEN CALLED "DEFINED BENEFIT" PLANS; TYPE B PLANS ARE OFTEN CALLED "DEFINED CONTRIBUTION."

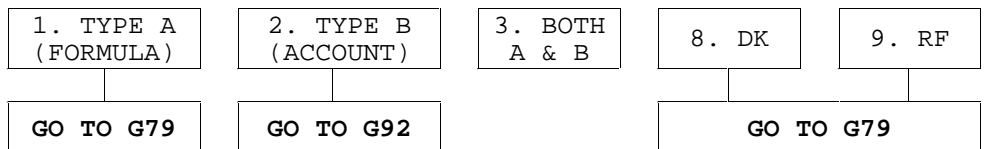

G78. For that part of your plan where money is accumulated in an account, how much is in the account at present?

\_\_\_\_\_

AMOUNT

DK	RF
----	----

G79. How much do you currently contribute (as a percent of your pay or amount of money per month or year)?

[IWER: INCLUDE CONTRIBUTIONS THROUGH SALARY DEDUCTIONS, UNION DUES OR OTHER SOURCES]

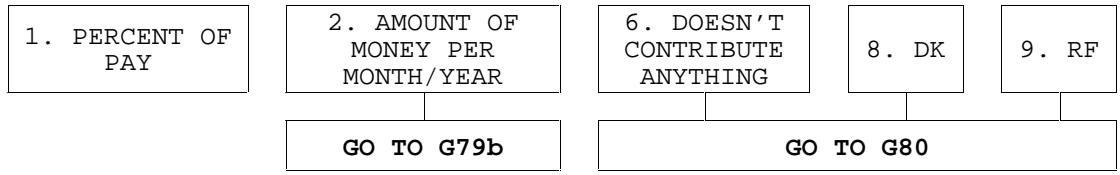

G79a. [IWER: ENTER PERCENT OF THE PAY]

1-100 PERCENT

	DK	RF
PERCENT		
GO TO G80		

G79b. [IWER: PROBE IF NECESSARY]  
How much do you currently contribute?]

[IWER: PROBE IF NECESSARY]  
Was that per month or year?

	DK	RF
AMOUNT		
GO TO G80		

G79c. PER:

01. HOUR	02. WEEK	03. EVERY TWO WEEKS/BI-WEEKLY	04. MONTH
06. YEAR	97. OTHER (SPECIFY)	98. DK	99. RF

G80. (Now, about the part of your pension where benefits are based on a formula.)

For how many years altogether have you been included in this plan?

[IWER: INCLUDE YEARS WITH OTHER EMPLOYERS IF SAME PLAN]

0-50 YEARS IN PLAN

	DK	RF
YEARS IN PLAN		

G81. At what age do you expect to start receiving benefits from this plan?

40-94 AGE  
96 ANSWER IN YEARS  
97 RECEIVING BENEFITS NOW

	96. ANSWER IN YEARS	97. RECEIVING BENEFITS NOW	DK	RF
AGE				
GO TO G82		GO TO G82b	GO TO G83	



G82d BRANCHPOINT: IF R IS RECEIVING BENEFITS NOW (G81=97) and DID NOT REPORT THAT RECEIVED A LUMP SUM PAYMENT (G82 NOT 3), GO TO G83

G82d. LUMP SUM AMOUNT:

\_\_\_\_\_

AMOUNT

DK

RF

G83. (Most pension plans have a normal retirement age at which full benefits--sometimes called unreduced benefits--can be received. Some plans allow retirement at an earlier age, usually with reduced benefits. And in many plans, normal retirement age depends on years of service.)

What is the earliest age at which you would be eligible to receive full or unreduced pension benefits from this job?

35-80 AGE

95 ANY TIME; NO AGE REUIREMENT; ANY AGE

\_\_\_\_\_

AGE

95. ANY TIME; NO AGE REQUIREMENT; ANY AGE

DK

RF

GO TO G86

G84 BRANCHPOINT: IF AGE R IS ELIGIBLE FOR BENEFITS (G83) IS SAME AS AGE R EXPECTS BENEFITS (G81), GO TO G85

G84. How much would these full or unreduced benefits be as a percentage of your pay at retirement or amount of dollars per month or year?

1. PERCENT OF PAY

2. AMOUNT PER MONTH/YEAR

3. LUMP SUM

8. DK

9. RF

GO TO G84b

GO TO G84d

GO TO G85

G84a. [IWER: ENTER PERCENT OF FINAL PAY AT RETIREMENT]

1-100 PERCENT

\_\_\_\_\_

PERCENT

DK

RF

GO TO G85



G84b. [IWER: PROBE IF NECESSARY]  
How much would you receive?

[IWER: PROBE IF NECESSARY]  
Is that per month or year?

	DK	RF
AMOUNT	GO TO G85	

G84c. PER:

01. HOUR	02. WEEK	03. EVERY TWO WEEKS/BI-WEEKLY	04. MONTH
GO TO G85			
06. YEAR	97. OTHER (SPECIFY) _____	98. DK	99. RF
GO TO G85			

G84d. LUMP SUM AMOUNT:

	DK	RF
AMOUNT		

G85. If you work [at this business/with this employer] until *AGE ELIGIBLE FOR PENSION (G83)*, how much do you expect your pay to be?

[IWER: IF PER HOUR BE SURE TO ADD .00 FOR CENTS IF THERE ARE NONE]

[IWER: PROBE IF NECESSARY]  
Was that per week, month, or year?

	DK	RF
AMOUNT	GO TO G86	

G85a. PER:

01. HOUR	02. WEEK	03. EVERY TWO WEEKS/BI-WEEKLY	04. MONTH
06. YEAR	97. OTHER (SPECIFY) _____	98. DK	99. RF

G86. What is the earliest age at which you could leave this [business/employer] and start to receive pension benefits?

35-80 AGE

95 ANY TIME; NO AGE REUIREMENT; ANY AGE

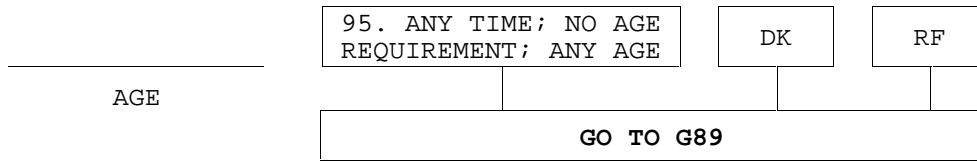

G88 BRANCHPOINT: IF EARLIEST AGE R COULD {LEAVE JOB AND RECEIVE PENSION BENEFITS} (G86) IS SAME AS {EARLIEST AGE R COULD RECEIVE FULL PENSION (G83) or AGE R EXPECTS TO RECEIVE BENEFITS (G81)}, GO TO G89

G88. By how much would your pension be reduced from full benefits if you left this job at *EARLIEST AGE TO RECEIVE PENSION (G86)*?

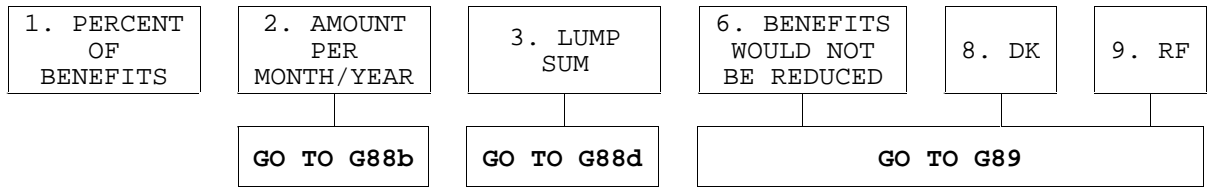

G88a. [IWER: ENTER PERCENT BY WHICH FULL BENEFITS ARE REDUCED]

1-100 PERCENT

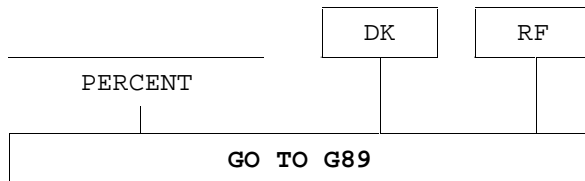

G88b. [IWER: PROBE IF NECESSARY]  
How much would your benefits be reduced?

[IWER: PROBE IF NECESSARY]  
Was that per month or year?

	DK	RF
AMOUNT		
<b>GO TO G89</b>		

G88c. PER:

01. HOUR	02. WEEK	03. EVERY TWO WEEKS/BI-WEEKLY	04. MONTH
<b>GO TO G89</b>			
06. YEAR	97. OTHER (SPECIFY)	98. DK	99. RF
<b>GO TO G89</b>			

G88d. LUMP SUM AMOUNT:

	DK	RF
AMOUNT		

G89. Does the amount of your pension depend on Social Security benefits, in that when you start receiving Social Security benefits your pension benefits will be reduced?

1. YES	5. NO	8. DK	9. RF
<b>GO TO G90</b>			

G89a. When will this change take place: automatically at age 62, automatically at age 65, when you start receiving Social Security benefits, or at some other time?

1. AT AGE 62	2. AT AGE 65	3. WHEN SOCIAL SECURITY BENEFITS BEGIN	4. AT SOME OTHER TIME	8. DK	9. RF
-----------------	-----------------	--	--------------------------	-------	-------

G90 BRANCHPOINT: IF R EXPECTS OR RECEIVED A LUMP SUM BENEFIT (G82), GO TO END OF G77 LOOP (AFTER G101c)

G90. Rather than regular retirement benefits, could you choose to receive a lump-sum settlement from this plan when you retire?

1. YES	2. YES, PARTIAL LUMP SUM	5. NO	8. DK	9. RF
GO TO END OF G77 LOOP (AFTER G101c)				

G92. (Could you tell me a little more about this plan?)  
Is it a thrift or savings plan, a 401K, a 403B, a Supplemental Retirement Account, a profit-sharing plan, a stock purchase plan, a money purchase plan, or what?

01. THRIFT OR SAVINGS	02. 401K	03. 403B	04. SUPPLEMENTAL RETIREMENT ACCOUNT	05. PROFIT SHARING
06. STOCK PURCHASE, ESOP		07. MONEY PURCHASE	97. OTHER (SPECIFY) _____	98. DK
99. RF				

G93. For how many years altogether have you been included in this plan?

[IWER: INCLUDE YEARS WITH OTHER EMPLOYERS, IF SAME PLAN]

0-50 YEARS IN THIS PLAN

\_\_\_\_\_

DK	RF
----	----

YEARS WITH PLAN

G94. How much does your [business/employer] contribute (as a percent of your pay or amount of money per month or year)?

1. PERCENT OF PAY	2. AMOUNT OF MONEY PER MONTH/YEAR	6. DOESN'T CONTRIBUTE ANYTHING	8. DK	9. RF
GO TO G94b		GO TO G95		

G94a. [IWER: ENTER PERCENT OF PAY]

1-100 PERCENT

\_\_\_\_\_

DK	RF
----	----

PERCENT

GO TO G95

G94b. [IWER: ENTER EMPLOYER CONTRIBUTED AMOUNT]

[IWER: PROBE IF NECESSARY]  
Was that per month or year?

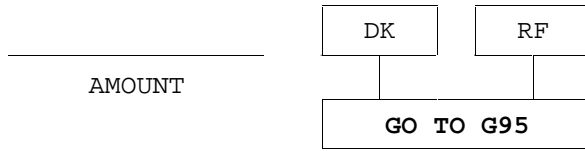

G94c. PER:

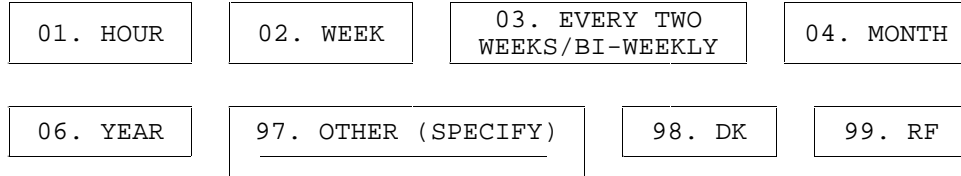

G95. How much do you currently contribute, that is, what is the sum of any amount that you are required to contribute plus any amount that you voluntarily contribute?

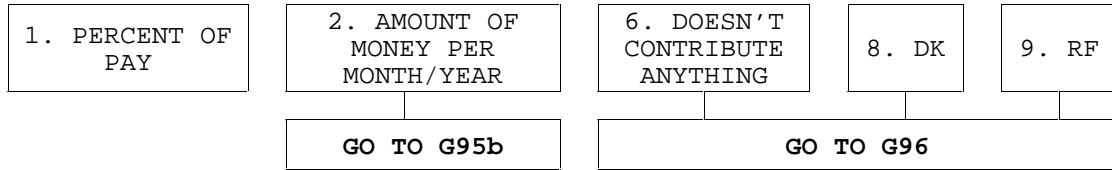

G95a. [IWER: ENTER PERCENT OF PAY]

1-100 PERCENT

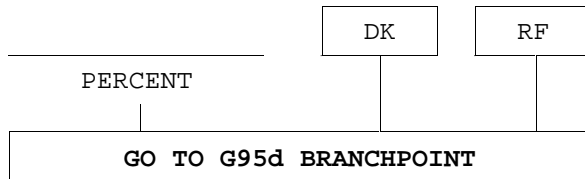

G95b. [IWER: PROBE IF NECESSARY]  
How much do you contribute?

[IWER: PROBE IF NECESSARY]  
Was that per month or year?

_____	DK	RF
AMOUNT		
GO TO G95d BRANCHPOINT		

G95c. PER:

01. HOUR	02. WEEK	03. EVERY TWO WEEKS/BI-WEEKLY	04. MONTH
06. YEAR	97. OTHER (SPECIFY) _____	98. DK	99. RF

G95d BRANCHPOINT: IF R DID NOT REPORT THAT {S/HE or EMPLOYER} CONTRIBUTES ANYTHING TO PENSION PLAN ({G94 or G95}={6 or DK or RF}), GO TO G96

G95d. If you wanted to reduce your contribution as low as possible while still having your [business/employer] contribute something to the plan, how far could you reduce it?

[IWER: ENTER MINIMUM PERCENT OF PAY THAT R CAN CONTRIBUTE BEFORE EMPLOYER/BUSINESS WOULD STOP MAKING ANY CONTRIBUTION]

[IWER: ENTER 0 IF EMPLOYER/BUSINESS WOULD MAKE CONTRIBUTION EVEN IF RESPONDENT MADE NO CONTRIBUTION]

[IWER: ENTER 95 IF RESPONDENT COULD NOT REDUCE HIS/HER CONTRIBUTION]

[IWER: IF RESPONDENT GIVES DOLLAR AMOUNT, ENTER ALT-D AND USE F2 COMMENT]

_____	DK	RF
MINIMUM PERCENT		

G96. How much money is in your account at present?

_____	DK	RF
AMOUNT		

G97. Are you able to choose how the money in your account is invested?

1. YES	5. NO	8. DK	9. RF
GO TO G99			

G98. Is the money in this account invested mostly in stocks, mostly in interest earning assets, is it about evenly split between these, or what?

1. MOSTLY OR ALL STOCK	2. MOSTLY OR ALL INTEREST EARNING	3. SPLIT	7. OTHER (SPECIFY) _____	8. DK	9. RF
------------------------------	--	----------	--------------------------------	-------	-------

G99. Does this plan allow you to receive benefits in the form of a lump sum payment?

1. YES	2. YES, PARTIAL LUMP SUM	5. NO	8. DK	9. RF
--------	--------------------------	-------	-------	-------

GO TO G100a

G100. Does it allow you to receive benefits in the form of installments or a monthly pension?

1. YES	5. NO	8. DK	9. RF
--------	-------	-------	-------

GO TO G101

G100a. What is the youngest age at which you could [stop working at this business/leave this employer] and start receiving a monthly pension or installments from this plan?

\_\_\_\_\_

AGE

95. ANY TIME; NO AGE REQUIREMENT; ANY AGE	DK	RF
--	----	----

G101. At what age do you expect to start receiving any benefits from this plan?

\_\_\_\_\_

AGE

95. RECEIVING BENEFITS NOW	DK	RF
-------------------------------	----	----

GO TO G101b

G101a BRANCHPOINT: IF R's PLAN ALLOWS A LUMP SUM PAYMENT (G99=1) and NOT INSTALLMENTS (G100=5), GO TO G101b BRANCHPOINT

G101a. In what form do you expect to receive benefits? (As a lump sum payment, as a monthly pension, as installments, or what?)

1. LUMP SUM	2. MONTHLY PENSION	3. INSTALLMENTS	7. OTHER (SPECIFY) _____	8. DK	9. RF
GO TO END OF G77 LOOP (AFTER G101c)					

NOTE: INTERVIEWERS COULD CHOOSE ALL OF THE RESPONSES, ABOVE, THAT APPLIED.

G101b BRANCHPOINT: IF R DID NOT REPORT RECEIVING BENEFITS NOW (G100 NOT 95), GO TO END OF G77 LOOP (AFTER G101c)

G101b. How much are you receiving?

_____	DK	RF
AMOUNT	GO TO END OF G77 LOOP (AFTER G101c)	

G101c. PER:

01. HOUR	02. WEEK	03. EVERY TWO WEEKS/BI-WEEKLY	04. MONTH
06. YEAR	97. OTHER (SPECIFY) _____	98. DK	99. RF

\*\*\*END OF G77 LOOP: IF THERE ARE MORE PENSION PLANS GIVEN, REPEAT QUESTIONS G77 THROUGH G101b FOR UP TO THREE PENSION PLANS. IF NOT, CONTINUE ON TO G103 BRANCHPOINT.\*\*\*

G103 BRANCHPOINT: IF R HAS LESS THAN 4 PLANS, GO TO G105 BRANCHPOINT

G103. Altogether how much do you have in your account balance(s) for any other pension plans or savings plan(s) from this job?

_____	DK	RF
AMOUNT		

G105 BRANCHPOINT: IF R HAS SAME JOB TITLE AS LAST IW, or {IF R IS CURRENTLY SELF-EMPLOYED, and R WAS SELF-EMPLOYED AT LAST IW, and THE MONTH AND YEAR GIVEN THAT S/HE STARTED WORKING CURRENT JOB IS ON OR BEFORE THE MONTH AND YEAR S/HE GAVE AT LAST IW}, GO TO G109



G105. Counting high school graduation as 12 years, about how many years of school would you say are needed to do your job reasonably well?

\_\_\_\_\_

NUMBER OF YEARS

DK	RF
----	----

GO TO G109  
BRANCHPOINT

G105a. (For someone with this much formal schooling,) About how much experience do you think it would take to become good at your job?

\_\_\_\_\_

AMOUNT OF EXPERIENCE

DK	RF
----	----

GO TO G109

G105b. UNIT:

1. HOURS	2. WEEKS	4. MONTHS	6. YEARS
7. OTHER (SPECIFY) _____		8. DK	9. RF

G109 BRANCHPOINT: IF PROXY INTERVIEW, GO TO G128

G109. Sometimes people look for a different job even when they are currently working.

Are you currently looking for another job?

1. YES	5. NO	8. DK	9. RF
--------	-------	-------	-------

GO TO G114

G110. Are you looking for jobs only in this area, or are you considering jobs that would require you to move?

1. JOBS IN THIS AREA	2. JOBS REQUIRING A MOVE	3. BOTH/ EITHER ONE	8. DK	9. RF
----------------------	--------------------------	---------------------	-------	-------

G111. Are you looking for part-time or full-time work?

1. PART-TIME	2. FULL-TIME	3. EITHER KIND	8. DK	9. RF
--------------	--------------	----------------	-------	-------

G112. Are you looking for the same kind of work you're doing now, or something different?

1. SAME	2. EITHER/BOTH	3. DIFFERENT	8. DK	9. RF
GO TO G113			GO TO G113	

G112a. How would it be different?

\_\_\_\_\_

\_\_\_\_\_

DK	RF
----	----

G113. During the past four weeks, what have you been doing to find another job?

[IWER: DO NOT READ CATEGORIES. CHOOSE ALL THAT APPLY.]

01. CHECKED WITH PUBLIC EMPLOYMENT AGENCY	02. CHECKED WITH PRIVATE EMPLOYMENT AGENCY	03. VISITED EMPLOYERS DIRECTLY	04. TELEPHONED OR WROTE EMPLOYERS DIRECTLY
05. ASKED FRIENDS OR RELATIVES	06. PLACED OR ANSWERED ADS	07. READ ADS	08. DIDN'T DO ANYTHING SPECIFIC
97. OTHER (SPECIFY) _____		98. DK	99. RF

G113e1 BRANCHPOINT: IF R DID NOT VISIT EMPLOYERS DIRECTLY (G113 NOT 3), GO TO G113f1 BRANCHPOINT

G113e1. How many employers did you visit?

\_\_\_\_\_

DK	RF
----	----

NUMBER OF EMPLOYERS

G113f1 BRANCHPOINT: IF R DID NOT {TELEPHONE OR WRITE} EMPLOYERS DIRECTLY (G113 NOT 4), GO TO G114

G113f1. How many employers did you call or write?

\_\_\_\_\_

DK	RF
----	----

NUMBER OF EMPLOYERS

G114 BRANCHPOINT: IF R WAS ASKED WHAT S/HE WAS DOING TO FIND ANOTHER JOB AT G113, GO TO G115 BRANCHPOINT

G114. If you found out about another job like the one you have now, would you look into it?

1. YES	2. PROBABLY	3. MAYBE	4. PROBABLY NOT
5. NO	7. OTHER (SPECIFY) _____	8. DK	9. RF

G115 BRANCHPOINT: IF R IS IN NURSING HOME *and* HAS NO RESIDENCE OUTSIDE OF NURSING HOME, GO TO G141 BRANCHPOINT

IF R HAS SAME JOB TITLE AS LAST IW (G21=1), GO TO G127

IF R IS SELF-EMPLOYED (G3=2) *and* WAS SELF-EMPLOYED AT R's LAST IW, GO TO G127

OTHERWISE, GO TO G126

G115. Have you been doing anything to find work during the last four weeks?

1. YES	5. NO	8. DK	9. RF
GO TO G119			

G116. Are you looking for part-time or full-time work?

1. PART-TIME	2. FULL-TIME	3. EITHER KIND	8. DK	9. RF
--------------	--------------	----------------	-------	-------

G117. Are you looking for the same kind of work you did before, or something different?

1. SAME	2. EITHER OR BOTH	3. DIFFERENT	8. DK	9. RF
GO TO G117b			GO TO G117b	

G117a. How would it be different?

\_\_\_\_\_

\_\_\_\_\_

DK	RF
----	----

G117b. If you were to be offered work like that, how high would the wage or salary have to be for you to take it?

[IWER: IF PER HOUR BE SURE TO ADD .00 FOR CENTS IF THERE ARE NONE]

[IWER: PROBE IF NECESSARY]

Is that per hour, week, month, or year?

_____	DK	RF
AMOUNT		
<b>GO TO G118</b>		

G117b. PER:

01. HOUR	02. WEEK	03. EVERY TWO WEEKS/BI-WEEKLY	04. MONTH
06. YEAR	97. OTHER (SPECIFY) _____	98. DK	99. RF

G118. What are all of the things you have done to find work during the last four weeks?

[IWER: DO NOT READ CATEGORIES. CHOOSE ALL THAT APPLY.]

01. READ ADS	02. ATTEND SCHOOL OR RECEIVED OTHER TRAINING	03. CHECKED WITH PUBLIC EMPLOYMENT AGENCY	04. CHECK WITH PRIVATE EMPLOYMENT AGENCY
05. VISITED EMPLOYERS DIRECTLY	06. TELEPHONED OR WROTE EMPLOYERS DIRECTLY	07. ASKED FRIENDS OR RELATIVES	08. PLACED OR ANSWERED ADS
96. DIDN'T DO ANYTHING SPECIFIC	97. OTHER (SPECIFY) _____	98. DK	99. RF
<b>GO TO G121</b>			

G118 BRANCHPOINT: IF R {DID NOT VISIT *and* DID NOT TELEPHONE} ANY EMPLOYERS DIRECTLY (G118 {NOT 5 *and* NOT 6}), GO TO G134

G118e1/f1. How many employers did you [visit/call or write/visit, call, or write]?

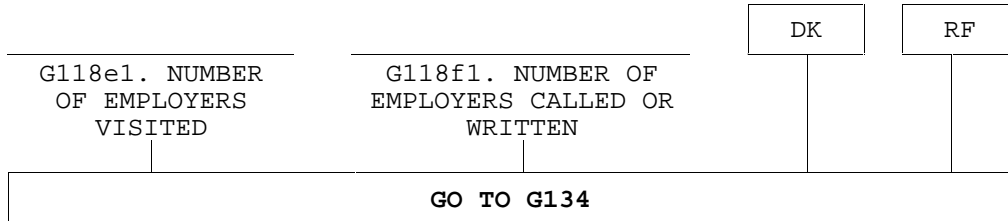

G119. Do you currently want a job, either full-time or part-time?

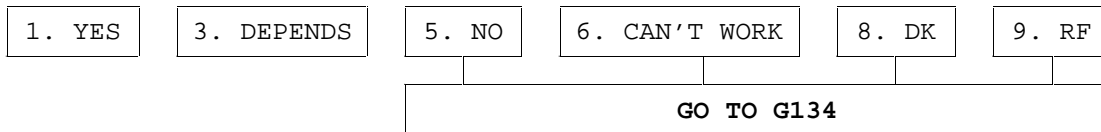

G119a. Would you prefer part-time or full-time?



G120. If someone offered you a regular job now, how high would the wage or salary have to be for you to take it?

[IWER: IF PER HOUR BE SURE TO ADD .00 FOR CENTS IF THERE ARE NONE]

[IWER: PROBE IF NECESSARY]

Is that per hour, week, month, or year?

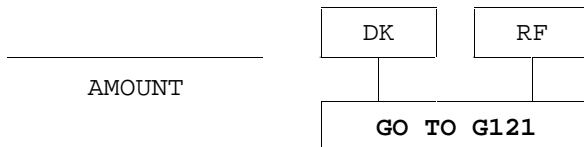

G120a. PER:

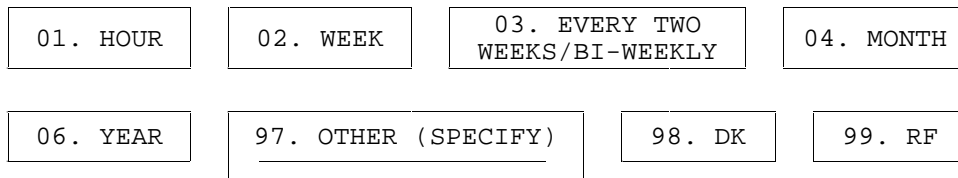

G121. What is the main reason you were not looking for work during the last four weeks?

[IWER: DO NOT READ CATEGORIES]

01. BELIEVES NOTHING AVAILABLE IN LINE OF WORK	02. DOESN'T BELIEVE CAN FIND WORK	03. DOESN'T HAVE NEEDED SKILLS/EXPERIENCE	04. BELIEVES EMPLOYERS THINK TOO OLD
GO TO G134			

05. BELIEVES EMPLOYERS WON'T HIRE OLDER WOMEN MINORITIES	06. POOR HEALTH, DISABILITY	07. FAMILY RESPONSIBILITIES /CHILD RESPONSIBILITIES	08. TRANSPORTATION PROBLEMS
GO TO G134			

95. NO PARTICULAR REASON	97. OTHER (SPECIFY) _____	98. DK	99. RF
GO TO G134			

G126. I'll read some statements that are true for some people's jobs but not for other people's jobs. Thinking of your job, please tell me how often these statements are true.

	1. ALL OR ALMOST ALL OF THE TIME	2. MOST OF THE TIME	3. SOME OF THE TIME	4. NONE OR ALMOST NONE OF THE TIME	8. DK	9. RF
G126a. My job requires lots of physical effort. Is this true all or almost all of the time, most of the time, some of the time, or none or almost none of the time?						
G126b. (My job requires) lifting heavy loads. (Is this true all or almost all of the time, most of the time, some of the time, or none or almost none of the time?)						
G126c. (My job requires) stooping, kneeling, or crouching. (Is this true all or almost all of the time, most of the time, some of the time, or none or almost none of the time?)						
G126d. My job requires good eyesight. (Is this true all or almost all of the time, most of the time, some of the time, or none or almost none of the time?)						
G126e. (My job requires) intense concentration or attention. (Is this true all or almost all of the time, most of the time, some of the time, or none or almost none of the time?)						
G126f. (My job requires) skill in dealing with other people. (Is this true all or almost all of the time, most of the time, some of the time, or none or almost none of the time?)						

G127. Here are some (more) statements that are true for some people's jobs but not for others. (Again) Thinking of your job, [please/this time] indicate how much you agree or disagree with each statement.

	1. STRONGLY AGREE	2. AGREE	3. DISAGREE	4. STRONGLY DISAGREE	8. DK	9. RF
G127a. My job requires me to do more difficult things than it used to. Do you strongly agree, agree, disagree or strongly disagree with that statement?						
G127b. My job involves a lot of stress. (Do you strongly agree, agree, disagree or strongly disagree with that statement?)						

G127c BRANCHPOINT: IF R IS SELF-EMPLOYED (G3=2), GO TO G127e



	1. STRONGLY AGREE	2. AGREE	3. DISAGREE	4. STRONGLY DISAGREE	8. DK	9. RF
G127c. In decisions about promotion, my employer gives younger people preference over older people. (Do you strongly agree, agree, disagree or strongly disagree with that statement?)						
G127d. My co-workers make older workers feel that they ought to retire before age 65. (Do you strongly agree, agree, disagree or strongly disagree with that statement?)						
G127e. As I get older, I would prefer to gradually reduce the hours I work on this job, keeping my pay per hour the same. (Do you strongly agree, agree, disagree or strongly disagree with that statement?)						

G127f BRANCHPOINT: IF R IS SELF-EMPLOYED (G3=2), GO TO G127g

	1. STRONGLY AGREE	2. AGREE	3. DISAGREE	4. STRONGLY DISAGREE	8. DK	9. RF
G127f. My employer would let older workers move to a less demanding job with less pay if they wanted to. (Do you strongly agree, agree, disagree or strongly disagree with that statement?)						
G127g. I really enjoy going to work. (Do you strongly agree, agree, disagree or strongly disagree with that statement?)						

G128. Are you doing any other work for pay now, such as (another) business of your own, a second job or the military reserves?

1. YES	5. NO	8. DK	9. RF
GO TO G132			

G128a. Is this your own business, a second job, the military reserves, or what?

[IWER: CHOOSE ALL THAT APPLY]

1. OWN BUSINESS	2. SECOND JOB	3. MILITARY RESERVES	7. OTHER (SPECIFY) _____	8. DK	9. RF
-----------------	---------------	----------------------	-----------------------------	-------	-------

G129. How many hours a week do you usually work on [this other job/these other jobs]?

\_\_\_\_\_

DK	RF
----	----

HOURS

G130. Counting paid vacations as weeks of work, how many weeks a year do you usually work on (this other job/these other jobs)?

\_\_\_\_\_

DK	RF
----	----

WEEKS

G131. About how much do you earn before taxes from [this other job/these other jobs]?

[IWER: IF PER HOUR BE SURE TO ADD .00 FOR CENTS IF THERE ARE NONE]

[IWER: PROBE IF NECESSARY]

Is that per hour, week, month, year, or what?

\_\_\_\_\_

AMOUNT

DK	RF
GO TO G132	

G131a. PER:

01. HOUR	02. WEEK	03. EVERY TWO WEEKS/BI-WEEKLY	04. MONTH
06. YEAR	97. OTHER (SPECIFY) _____	98. DK	99. RF

G132. Now I have a few questions about work and retirement.

On your main job, what is the usual retirement age for people who work with you or have the same kind of job?

\_\_\_\_\_

YEARS OF AGE

95. NO "USUAL"	96. ANSWER IN YEARS OF SERVICE	DK	RF
GO TO G133 BRANCHPOINT		GO TO G133 BRANCHPOINT	

G132a. [IWER: ENTER USUAL NUMBER OF YEARS OF SERVICE:]

\_\_\_\_\_

YEARS OF SERVICE

DK	RF
----	----

G133 BRANCHPOINT: IF PROXY INTERVIEW, GO TO G141 BRANCHPOINT

G133. Now I want to ask about your retirement plans.

Do you plan to stop working altogether or reduce work hours at a particular date or age, have you not given it much thought, or what?

[IWER: DO NOT PROBE BUT CHOOSE ALL THAT APPLY AND ASK ALL FOLLOW-UP QUESTIONS.]

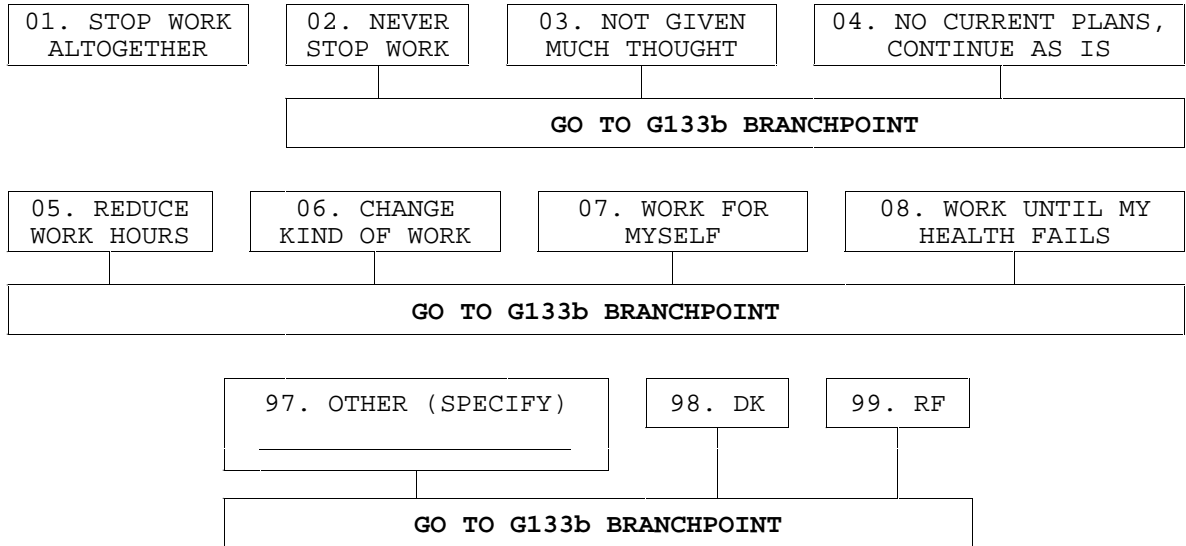

G133a. At what age do you plan to stop working?

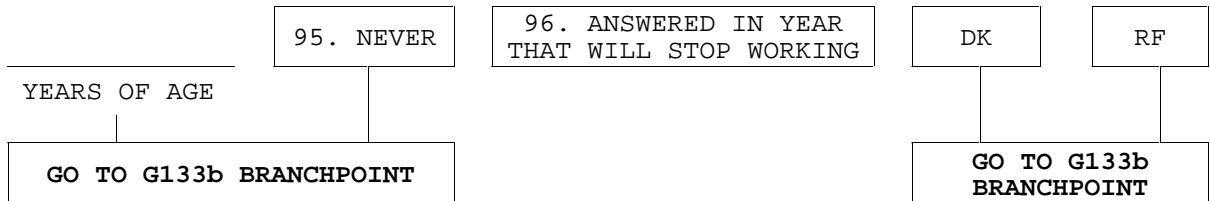

G133a1. ENTER YEAR PLANNING TO STOP WORKING

[IWER: 1998-2020 YEAR PLANNING TO STOP WORKING  
9995 NEVER]

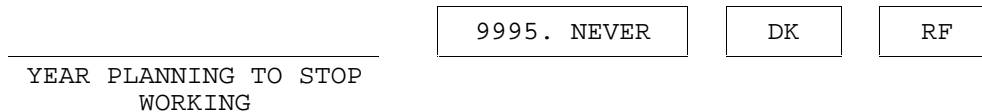

G133b BRANCHPOINT: IF R DID NOT SAY THAT {HAD NOT GIVEN MUCH THOUGHT TO *and* HAD NO CURRENT} RETIREMENT PLANS (G133 {NOT 3 *and* NOT 4}), GO TO G133c BRANCHPOINT

G133b. At what age do you think you will stop working?

_____	95. NEVER	96. ANSWERED IN YEAR THAT WILL STOP WORKING	DK	RF
YEARS OF AGE				
	GO TO G133c BRANCHPOINT		GO TO G133c BRANCHPOINT	

G133b1. ENTER YEAR THINKING TO STOP WORKING:

[IWER: 1998-2020 YEAR PLANNING TO STOP WORKING  
9995 NEVER]

_____	9995. NEVER	DK	RF
YEAR PLANNING TO STOP WORKING			

G133c BRANCHPOINT: IF R DID NOT SAY S/HE PLANS TO REDUCE WORK HOURS  
(G133 NOT 5), GO TO G133d BRANCHPOINT

G133c. At what age do you plan to start working fewer hours?

_____	95. NEVER	96. YEAR PLANNING TO START WORKING FEWER HOURS	DK	RF
YEARS OF AGE				
	GO TO G133d BRANCHPOINT		GO TO G133d BRANCHPOINT	

G133c1. ENTER YEAR PLANNING TO START WORKING FEWER HOURS:

[IWER: 1998-2020 YEAR PLANNING TO START WORKING FEWER HOURS]

_____	DK	RF
YEAR PLANNING TO START WORKING FEWER HOURS		

G133d BRANCHPOINT: IF R DID NOT SAY S/HE PLANS TO CHANGE KIND OF WORK  
(G133 NOT 6), GO TO G133e

G133d. At what age do you plan to change the kind of work you do?

_____	95. NEVER	96. YEAR PLANNING TO CHANGE WORK	DK	RF
YEARS OF AGE				
	GO TO G133e BRANCHPOINT		GO TO G133e BRANCHPOINT	

G133d1. ENTER YEAR PLANNING TO CHANGE WORK:

[IWER: 1998-2020 YEAR PLANNING TO CHANGE WORK]

	DK	RF
YEAR PLANNING TO CHANGE WORK		

G133e BRANCHPOINT: IF R DOES NOT PLAN TO WORK FOR HIM/HERSELF (G133 NOT 7),  
GO TO G134

G133e. At what age do you plan to start working for yourself?

	95. NEVER	96. YEAR PLANNING SELF-EMPLOYMENT	DK	RF
YEARS OF AGE				
GO TO G134			GO TO G134	GO TO G134

G133e1. ENTER YEAR PLANNING TO START SELF-EMPLOYMENT:

[IWER: 1998-2020 YEAR STARING SELF EMPLOYMENT]

	DK	RF
YEAR STARTING SELF EMPLOYMENT		

G134. We are interested in what people think about retirement, whether they themselves are retired or not.

At this time do you consider yourself partly retired, completely retired, or not retired at all?

1. COMPLETELY RETIRED	3. PARTLY RETIRED	5. NOT RETIRED AT ALL
		GO TO G139 BRANCHPOINT
7. QUESTION NOT RELEVANT TO R, DOESN'T WORK FOR PAY OR IS HOMEMAKER, HASN'T WORKED FOR 1 OR MORE YEARS		8. DK
GO TO G141 BRANCHPOINT		9. RF

G134a BRANCHPOINT: IF R IS COMPLETELY RETIRED NOW (G134=1) and WAS COMPLETELY  
RETIRED AT R'S LAST IW, GO TO G136

IF R IS PARTLY RETIRED (G134=1) and WAS PARTLY RETIRED AT  
R'S LAST IW, GO TO G139 BRANCHPOINT

IF R GAVE YEAR S/HE RETIRED AT G1j, GO TO G135

G134a. In what month and year did you [partly/completely] retire?

[IWER: MONTHS ENTERED MUST BE BEFORE CURRENT IW MONTH, YEAR]

MONTH:

01. JAN	02. FEB	03. MAR	04. APR	05. MAY
06. JUN	07. JUL	08. AUG	09. SEP	10. OCT
11. NOV	12. DEC	98. DK	99. RF	

_____	DK	RF
-------	----	----

G134a. YEAR

G135. Thinking back to the time you [partly/completely] retired, was that something you wanted to do or something you felt you were forced into?

1. WANTED TO DO	2. FORCED INTO	3. PART WANTED, PART FORCED	8. DK	9. RF
-----------------	----------------	-----------------------------	-------	-------

G136 BRANCHPOINT: IF R IS NOT COMPLETELY RETIRED (G134=1), GO TO G139 BRANCHPOINT

G136. All in all, would you say that your retirement has turned out to be very satisfying, moderately satisfying, or not at all satisfying?

1. VERY SATISFYING	2. MODERATELY SATISFYING	3. NOT AT ALL SATISFYING	8. DK	9. RF
--------------------	--------------------------	--------------------------	-------	-------

G137. Thinking about your retirement years compared to the years just before you retired, would you say the retirement years have been better, about the same, or not as good?

1. BETTER	3. ABOUT THE SAME	5. NOT AS GOOD	6. RETIRED LESS THAN 1 YEAR AGO.	8. DK	9. RF
-----------	-------------------	----------------	----------------------------------	-------	-------

G138 BRANCHPOINT: IF R WAS COMPLETELY RETIRED AT LAST IW, GO TO G141 BRANCHPOINT

G138. I'm going to read you a list of reasons why some people retire. Please tell me whether, for you, these were very important reasons for retirement, moderately important, somewhat important, or not important at all.

G138a.	1. VERY IMPORTANT	2. MODERATELY IMPORTANT	3. SOMEWHAT IMPORTANT	4. NOT IMPORTANT AT ALL	8. DK	9. RF
Poor health (Was this a very important reason for your retirement, a moderately important reason, somewhat important, or not important at all?)						
Wanted to do other things (Was this a very important reason for your retirement, a moderately important reason, somewhat important, or not important at all?)						
Didn't like the work (Was this a very important reason for your retirement, a moderately important reason, somewhat important, or not important at all?)						
Wanted to spend more time with my family (Was this a very important reason for your retirement, a moderately important reason, somewhat important, or not important at all?)						

G139 BRANCHPOINT: IF REINTERVIEW R, GO TO G141 BRANCHPOINT



G139. Now I'm going to read you a list of things that some people say are good about retirement.

IF R IS COMPLETELY RETIRED (G134=1):

For each one, please tell me if, during your retirement, it has been very important, moderately important, somewhat important, or not important at all.

OTHERWISE:

For each one, please tell me if, for you, they are very important, moderately important, somewhat important, or not important at all.

G139a.	1. VERY IMPORTANT	2. MODERATELY IMPORTANT	3. SOMEWHAT IMPORTANT	4. NOT IMPORTANT AT ALL	8. DK	9. RF
Being your own boss ([Has this been/Is this] very important, moderately important, somewhat important, or not important at all?)						
Being able to take it easy. ([Has this been/Is this]) very important, moderately important, somewhat important, or not important at all?)						
Having the chance to travel. ([Has this been/Is this] very important, moderately important, somewhat important, or not important at all?)						

G140. Now for things that some people say are bad about retirement.

IF R IS COMPLETELY RETIRED (G134=1):

Please tell me if, during your retirement, they have bothered you a lot, somewhat, a little, or not at all.

OTHERWISE:

Please tell me if, they worry you a lot, somewhat, a little, or not at all.

G140a.	1. A LOT	2. SOMEWHAT	3. A LITTLE	4. NOT AT ALL	7. DIDN'T WORK	8. DK	9. RF
Not doing anything productive or useful. (Does this [bother/worry] you a lot, somewhat, a little, or not at all?)							
Illness or disability. (Does this [bother/worry] you a lot, somewhat, a little, or not at all?)							
Not having enough income to get by. (Does this [bother/worry] you a lot, somewhat, a little, or not at all?)							

G141 BRANCHPOINT: IF NEW INTERVIEW R, GO TO GASSIST

IF R IS STILL WORKING FOR LAST IW EMPLOYER ({G19a or G19b}=1), GO TO G146 BRANCHPOINT

IF R WAS WORKING FOR SOMEONE ELSE LAST IW *and* DID NOT GIVE A {MONTH AND YEAR} THAT S/HE STOPPED WORKING FOR THAT EMPLOYER (G26/26a={DK or RF}), GO TO G146 BRANCHPOINT

IF R WAS WORKING FOR SOMEONE ELSE LAST IW *and* STARTED WORKING AT CURRENT JOB/BUSINESS (G63/G63a) LESS THAN 2 MONTHS FROM WHEN S/HE STOPPED WORKING FOR LAST IW EMPLOYER (PER G26/26a), GO TO G146 BRANCHPOINT

IF R WAS SELF-EMPLOYED AT LAST IW *and* DID NOT GIVE {MONTH AND YEAR} THAT S/HE STOPPED WORKING AT THAT BUSINESS (G5/5a={DK or RF}), GO TO G146 BRANCHPOINT

IF R WAS {SELF-EMPLOYED AT LAST IW *and* IS CURRENTLY SELF-EMPLOYED (G2=2)} *and* {MONTH AND YEAR} STARTED WORKING FOR PREVIOUS EMPLOYER (PER G63/G63a) IS SAME AS OR BEFORE {MONTH AND YEAR} OF LAST IW, GO TO GASSIST

IF {MONTH AND YEAR} R STARTED CURRENT JOB/BUSINESS (PER G63/G63a) IS ON OR BEFORE {MONTH AND YEAR} OF R's LAST IW, GO TO G146 BRANCHPOINT

IF R WAS SELF-EMPLOYED AT LAST IW *and* {MONTH AND YEAR} R STARTED CURRENT JOB/BUSINESS (PER G63/G63a) IS LESS THAN 2 MONTHS FROM {MONTH AND YEAR} S/HE STOPPED WORKING FOR SELF (PER G5/5a), GO TO G146 BRANCHPOINT

IF R IS CURRENTLY WORKING (G2=1) *and* DID NOT GIVE {MONTH AND YEAR} S/HE STARTED CURRENT JOB/BUSINESS (PER G63/G63a), GO TO G146 BRANCHPOINT

G141. IF R IS CURRENTLY WORKING (G2=1):  
 Between [MONTH, YEAR STOPPED WORKING FOR LAST IW [EMPLOYER (per G26&G26a)/SELF (per G5&G5a)]]/R's LAST IW MONTH, YEAR] and MONTH, YEAR STARTED WORKING FOR {CURRENT EMPLOYER OR SELF} (per G63&G63a) did you do any work for pay?

OTHERWISE:  
 Since [MONTH, YEAR STOPPED WORKING FOR LAST IW [EMPLOYER (per G26&G26a)/SELF (per G5&G5a)]]/R's LAST IW MONTH, YEAR] did you do any work for pay?

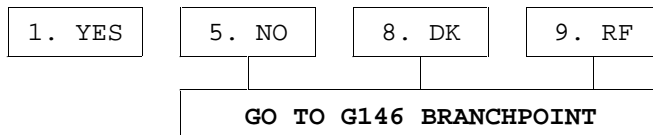

G142. IF R IS CURRENTLY WORKING:

During which months between [MONTH, YEAR STOPPED WORKING FOR LAST IW  
[EMPLOYER (per G26&G26a)/SELF (per G5&G5a)]/R's LAST IW MONTH, YEAR]  
and  
MONTH, YEAR STARTED WORKING FOR {CURRENT EMPLOYER OR SELF}  
(per G63&G63a) did you work for pay?

OTHERWISE:

During which months since [MONTH, YEAR STOPPED WORKING FOR LAST IW  
[EMPLOYER (per G26&G26a)/SELF (per G5&G5a)]/R's LAST IW MONTH, YEAR]  
did you work for pay?

[IWER: CHOOSE ALL THAT APPLY]

01. JAN 96	02. FEB 96	03. MAR 96	04. APR 96	05. MAY 96	06. JUN 96	07. JUL 96
08. AUG 96	09. SEP 96	10. OCT 96	11. NOV 96	12. DEC 96	13. JAN 97	14. FEB 97
15. MAR 97	16. APR 97	17. MAY 97	18. JUN 97	19. JUL 97	20. AUG 97	21. SEP 97
22. OCT 97	23. NOV 97	24. DEC 97	25. JAN 98	26. FEB 98	27. MAR 98	28. APR 98
29. MAY 98	30. JUN 98	31. JUL 98	32. AUG 98	33. SEP 98	34. OCT 98	35. NOV 98
36. DEC 98	37. ALL OF 1996 (AFTER PREV IW)		38. ALL OF 1997		39. ALL OF 1998 TO DATE	
40. MONTHS PRIOR TO 1996 _____			97. OTHER (SPECIFY) _____		98. DK	99. RF

G143. During these months, how many hours per week did you usually work?

\_\_\_\_\_

HOURS

DK	RF
----	----

G144. On average, how much were you earning before deductions during these months?

[IWER: IF PER HOUR BE SURE TO ADD .00 FOR CENTS IF THERE ARE NONE]

[IWER: PROBE IF NECESSARY]

Was that per hour, week, month, or year?

\_\_\_\_\_

AMOUNT

DK	RF
GO TO G144b	

G144a. PER:

01. HOUR	02. WEEK	03. EVERY TWO WEEKS/BI-WEEKLY	04. MONTH
06. YEAR	97. OTHER (SPECIFY) _____	98. DK	99. RF

G144b. Counting yourself as an employer if you were self employed, for how many employers did you work?

1. ONE	2. TWO OR MORE	8. DK	9. RF
GO TO G146 BRANCHPOINT			

G145. Why did you stop working at that job? (Did the business close, were you laid off or let go, did you leave to take care of family members or what?)

[IWER: CHOOSE ALL THAT APPLY]

01. BUSINESS CLOSED	02. LAID OFF/LET GO	03. POOR HEALTH/DISABLED	04. FAMILY CARE	05. BETTER JOB
GO TO G146 BRANCHPOINT				
06. QUIT	07. RETIRED	97. OTHER (SPECIFY) _____	98. DK	99. RF

G145a. Did your employment situation change in some way that encouraged you to leave?

1. YES	5. NO	8. DK	9. RF
GO TO G146 BRANCHPOINT			

G145b. How did it change?

[IWER: CHOOSE ALL THAT APPLY]

01. SUPERVISOR ENCOURAGED DEPARTURE	02. COWORKER ENCOURAGED DEPARTURE	03. WAGES REDUCED (OR ABOUT TO BE REDUCED)	04. HOURS REDUCED (OR ABOUT TO BE REDUCED)	
05. WOULD HAVE BEEN LAID OFF	06. NEW JOB DUTIES	07. NEW JOB LOCATION	08. BECAME ELIGIBLE FOR PENSION	
09. EMPLOYER CHANGED HEALTH INSURANCE	10. SPECIAL EARLY RETIREMENT INCENTIVE OFFER	97. OTHER (SPECIFY) _____	98. DK	99. RF

G146 BRANCHPOINT: {IF R IS NOT CURRENTLY WORKING FOR PAY (G2=5) and WASN'T WORKING AT R's LAST IW} or IF NEW INTERVIEW R, GO TO GASSIST

G146. Employers sometimes encourage older workers to leave a firm at a particular time by offering a special financial incentive, like a cash bonus or improved pension benefits. These are often called "early retirement windows."

Have you been offered such an early retirement window at any time [since R's LAST IW MONTH, YEAR/in the last two years]?

1. YES	5. NO	8. DK	9. RF
GO TO GASSIST			

G146a. How many of these special incentive offers have you received [since R's LAST IW MONTH, YEAR/in the last two years]?

SPECIAL INCENTIVES	DK	RF
GO TO GASSIST		

\*\*\*BEGINNING OF G147a LOOP: QUESTIONS G147a THROUGH G153 ARE REPEATED FOR THE FIRST AND LAST SPECIAL INCENTIVES THE R RECEIVED.\*\*\*

G147a. In what month and year was the (first/last) special incentive offered?

[IWER: MONTHS ENTERED MUST BETWEEN [NOVEMBER, 1997/REINTERVIEW R's LAST IW MONTH, YEAR] AND CURRENT LAST IW MONTH, YEAR]

MONTH:

01. JAN	02. FEB	03. MAR	04. APR	05. MAY
06. JUN	07. JUL	08. AUG	09. SEP	10. OCT
11. NOV	12. DEC	98. DK	99. RF	
		DK	RF	

\_\_\_\_\_ YEAR

G148 BRANCHPOINT: IF R IS STILL WORKING FOR LAST IW EMPLOYER ({G19a or G19b}=1), GO TO G149

G148. Which employer were you working for at the time?

[IWER: ENTER FULL EMPLOYER NAME:]

1. LAST WAVE EMPLOYER NAME	2. CURRENT EMPLOYER NAME	7. OTHER (SPECIFY) _____	8. DK	9. RF
-------------------------------	-----------------------------	-----------------------------	-------	-------

G149. Was the special incentive a cash bonus, improved pension benefits or what?

[IWER: CHOOSE ALL THAT APPLY]

1. CASH BONUS	2. IMPROVED PENSION BENEFITS	3. PERMANENT MEDICAL INSURANCE	4. TEMPORARY MEDICAL INSURANCE
5. TEMPORARY CASH BENEFIT	6. ADDITIONAL YEARS OF SERVICE CREDITED	7. OTHER (SPECIFY) _____	8. DK
			9. RF

G150a BRANCHPOINT: IF R's OFFER DID NOT INCLUDE A CASH BONUS (G149 NOT 1), GO TO G150b BRANCHPOINT

G150a. How much did the cash bonus offer amount to?

\_\_\_\_\_

AMOUNT

DK	RF
----	----

G150b BRANCHPOINT: IF R's OFFER DID NOT INCLUDE IMPROVED PENSION BENEFIT (G149 NOT 2), GO TO G150c BRANCHPOINT

G150b. How much did the extra pension benefit offer amount to?

[IWER: IF PER HOUR BE SURE TO ADD .00 FOR CENTS IF THERE ARE NONE]

[IWER: PROBE IF NECESSARY]

Was that per week, year, or a lump sum?

\_\_\_\_\_

AMOUNT

DK	RF
----	----

GO TO G105c BRANCHPOINT

G150b. PER:

02. WEEK	04. MONTH	06. YEAR	95. LUMP SUM
97. OTHER (SPECIFY) _____	98. DK	99. RF	

G150c BRANCHPOINT: IF R's OFFER DID NOT INCLUDE TEMPORARY MEDICAL INSURANCE (G149 NOT 4), GO TO G150d BRANCHPOINT

G150c(1). Until what age was the temporary medical insurance offered?

_____	95. NUMBER OF YEARS GIVEN	96. ANSWERED YEAR	DK	RF
AGE				
GO TO G150d BRANCHPOINT		GO TO G150c(3)		GO TO G150d BRANCHPOINT

G150c(2). [IWER: PROBE IF NECESSARY]

For how many years was the temporary medical insurance offered?

\_\_\_\_\_

YEARS

98. DK	99. RF
--------	--------

GO TO G150d BRANCHPOINT



G150c(3). [IWER: PROBE IF NECESSARY]

Until which year did you receive the temporary medical insurance?

\_\_\_\_\_

YEAR

DK

RF

G150d BRANCHPOINT: IF R'S OFFER DID NOT INCLUDE TEMPORARY CASH BENEFITS (G149 NOT 5), GO TO G150g BRANCHPOINT

G150d. How much did the temporary cash benefits offer amount to?

[IWER: PROBE IF NECESSARY]  
Was that per month or year?

\_\_\_\_\_

AMOUNT

DK

RF

**GO TO G105f(1)**

G150e. PER:

01. HOUR	02. WEEK	03. EVERY TWO WEEKS/BI-WEEKLY	04. MONTH
06. YEAR	97. OTHER (SPECIFY) _____	98. DK	99. RF

G150f(1). Until what age was the temporary cash benefit offered?

\_\_\_\_\_

AGE

95. NUMBER OF YEARS GIVEN

96. ANSWERED YEAR

DK

RF

**GO TO G150g  
BRANCHPOINT**

**GO TO G150f(3)**

**GO TO G150g  
BRANCHPOINT**

G150f(2). [IWER: PROBE IF NECESSARY]

For how many years was the temporary cash benefit offered?

\_\_\_\_\_

YEARS

DK

RF

**GO TO G150g BRANCHPOINT**

G150f(3). [IWER: PROBE IF NECESSARY]

Until which year was the temporary cash benefit offered?

\_\_\_\_\_           

YEAR

G150g BRANCHPOINT: IF R's OFFER DID NOT INCLUDE ADDITIONAL YEARS OF SERVICE CREDIT (G149 NOT 6), GO TO G150h BRANCHPOINT

G150g. How many years of service credit were you offered?

\_\_\_\_\_           

YEARS

G150h BRANCHPOINT: IF R's OFFER DID NOT INCLUDE OTHER INCENTIVES (G149 NOT 7), GO TO G151

G150h. How much did the other incentive offers(s) amount to?

\_\_\_\_\_           

AMOUNT

G151. Did you accept the incentive and leave that employer?

1. YES	5. NO	8. DK	9. RF
<div style="border: 1px solid black; padding: 5px; margin: 5px auto; width: 80%;">GO TO G153</div>			

G152. Was the special incentive important in your decision, or would you probably have left at about that time anyway?

1. IMPORTANT IN MY DECISION	5. I WOULD HAVE LEFT ANYWAY	8. DK	9. RF
<div style="border: 1px solid black; padding: 5px; margin: 5px auto; width: 90%;">GO TO END OF G147a LOOP (AFTER G153)</div>			

G153. If you had been offered twice as much (to leave) at that time, would you have done so?

1. YES	5. NO	8. DK	9. RF
--------	-------	-------	-------

\*\*\*END OF G147a LOOP: REPEAT QUESTIONS G147a THROUGH G153 IF MORE THAN ONE EARLY OUT WINDOW WAS OFFERED. IF NOT, CONTINUE ON TO GASSIST.\*\*\*

GASSIST

IWER:

HOW OFTEN DID R RECEIVE ASSISTANCE WITH ANSWERS IN SECTION G — WORK?

1. NEVER

2. A FEW TIMES

3. MOST OR ALL OF THE TIME

GO TO SECTION GG