

SECTION V: CAPITAL GAINS (November 11, 1994)

BRANCHPOINT: IF THIS RESPONDENT IS NOT R1, GO TO NEXT SECTION

IF NO INDICATION THAT R OWNS PRIMARY OR SECONDARY RESIDENCE FROM WAVE I OR THIS WAVE DATA, GO TO BRANCHPOINT BEFORE V4

V1. Now I'd like to ask you some questions about the changes in your (family's) finances over the past several years. Since W1-MONTH W1-YEAR (MONTH/YEAR OF WAVE I INTERVIEW), have you [or your (husband/wife/partner)] bought or sold a home that was your primary residence or second home?

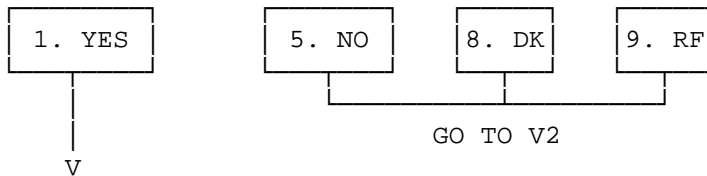

V1a. Did you only buy, only sell, both buy and sell, or what?

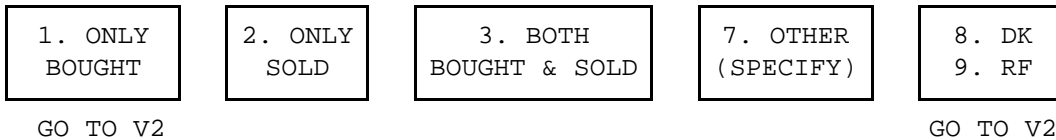

V1b. In what month and year did you most recently sell a home?

MONTH/YEAR

V1c. What was the selling price? [DO NOT PROBE DK.]

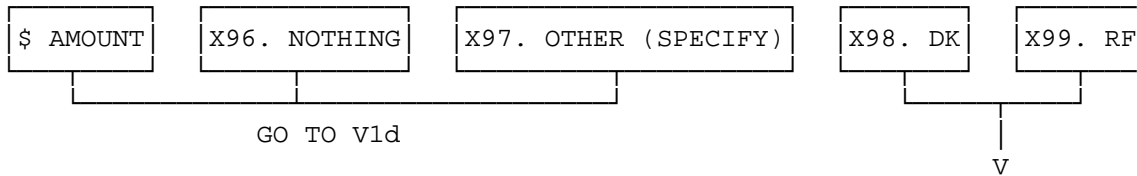

<p>V1c1*. Was it more than \$100,000?</p> <p>1. YES 5. NO 8. DK 9. RF</p> <p style="text-align: center;">↓ GO TO V1c3 GO TO V1d</p> <p style="text-align: center;">V</p>
<p>V1c2*. Was it more than \$250,000?</p> <p>1. YES 5. NO 8. DK 9. RF</p> <p style="text-align: center;">↓ ↓ ↓ ↓</p> <p style="text-align: center;">GO TO V1d</p>
<p>V1c3*. Was it more than \$50,000?</p> <p>1. YES 5. NO 8. DK 9. RF</p>

*Numbers 1, 2, and 3 after c do not appear in the CATI application but are used here (and subsequently) to identify the separate parts of the unfolding sequence.

SECTION V: CAPITAL GAINS (November 11, 1994)

V1d. And when did you buy that home?

MONTH/YEAR

V1e. What was the purchase price? [DO NOT PROBE DK.]

GO TO V1f

V

V1e1. Was it more than \$50,000?	1. YES	5. NO	8. DK	9. RF
	V	GO TO V1e3		GO TO V1f
V1e2. Was it more than \$150,000?	1. YES	5. NO	8. DK	9. RF
	GO TO V1f			
V1e3. Was it more than \$25,000?	1. YES	5. NO	8. DK	9. RF

V1f. Since W1-MONTH W1-YEAR, have you sold any other home that was your primary residence?

GO TO V2

V

V1g. In what month and year was this other home sold? [IF MORE THAN ONE, RECORD THE MOST RECENT SALE.]

MONTH/YEAR

V1h. What was the selling price? [DO NOT PROBE DK.]

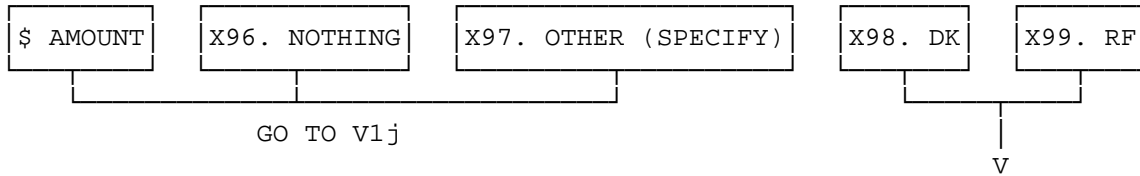

V1h1. Was it more than \$50,000?	1. YES	5. NO	8. DK	9. RF
	V	GO TO V1h3	GO TO V1j	
V1h2. Was it more than \$150,000?	1. YES	5. NO	8. DK	9. RF
	GO TO V1j			
V1h3. Was it more than \$25,000?	1. YES	5. NO	8. DK	9. RF

V1j. And when did you buy that home?

MONTH/YEAR

V1k. What was the purchase price? [DO NOT PROBE DK.]

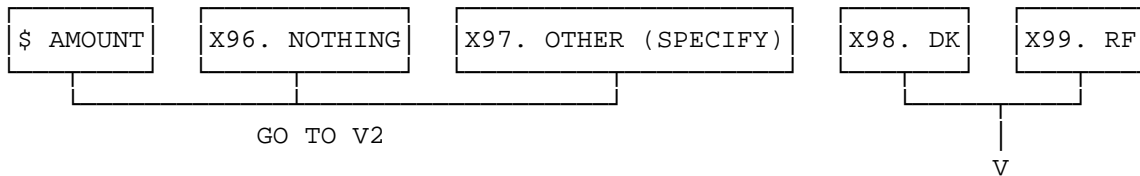

V1k1. Was it more than \$50,000	1. YES	5. NO	8. DK	9. RF
	V	GO TO V1k3	GO TO V2	
V1k2. Was it more than \$150,000?	1. YES	5. NO	8. DK	9. RF
	GO TO V2			
V1k3. Was it more than \$25,000?	1. YES	5. NO	8. DK	9. RF

SECTION V: CAPITAL GAINS (November 11, 1994)

V2. Since W1-MONTH W1-YEAR, did you [or your (husband/wife/partner)] make any major additions or home improvements to a primary residence or second home that you owned? [DO NOT COUNT GENERAL MAINTENANCE OR UPKEEP.]

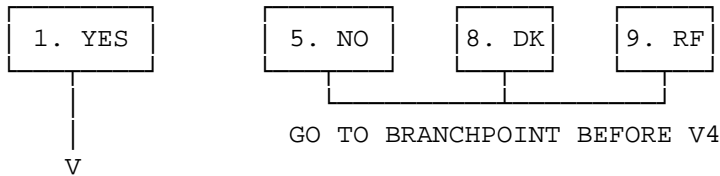

V2a. What was the dollar cost of these additions and improvements, plus the value of any work you may have done yourself? [DO NOT PROBE DK.]

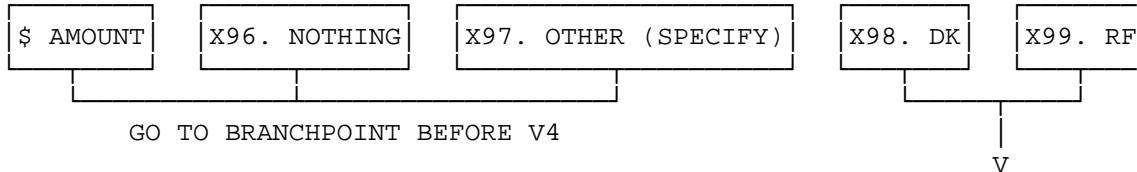

<p>V2a1. Was it more than \$10,000?</p>	<input type="checkbox"/> 1. YES ↓ V	<input type="checkbox"/> 5. NO GO TO V2a3	<input type="checkbox"/> 8. DK ↓ GO TO BRCHPT BEFORE V4	<input type="checkbox"/> 9. RF ↓ GO TO BRCHPT BEFORE V4
<p>V2a2. Was it more than \$50,000?</p>	<input type="checkbox"/> 1. YES ↓ GO TO BRANCHPOINT BEFORE V4	<input type="checkbox"/> 5. NO ↓ GO TO BRANCHPOINT BEFORE V4	<input type="checkbox"/> 8. DK ↓ GO TO BRANCHPOINT BEFORE V4	<input type="checkbox"/> 9. RF ↓ GO TO BRANCHPOINT BEFORE V4
<p>V2a3. Was it more than \$2,000?</p>	<input type="checkbox"/> 1. YES ↓ GO TO BRANCHPOINT BEFORE V4	<input type="checkbox"/> 5. NO ↓ GO TO BRANCHPOINT BEFORE V4	<input type="checkbox"/> 8. DK ↓ GO TO BRANCHPOINT BEFORE V4	<input type="checkbox"/> 9. RF ↓ GO TO BRANCHPOINT BEFORE V4

BRANCHPOINT: IF REPORTED OWNING NO REAL ESTATE OTHER THAN PRIMARY RESIDENCE OR SECOND HOME IN WAVE II (K2=NO,DK,RF) AND WAVE I (M2=NO,DK,RF), GO TO BRANCHPOINT BEFORE V8

V4. Since W1-MONTH W1-YEAR, have you [or your (husband/wife/partner)] sold any real estate other than your principle residence or second home, such as land, or rental or investment property?

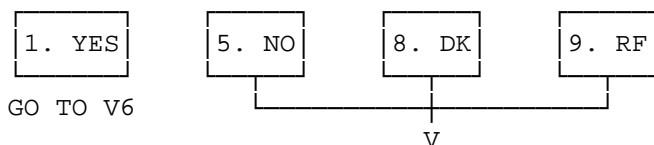

V4a. Have you bought any such real estate properties since W1-MONTH W1-YEAR?

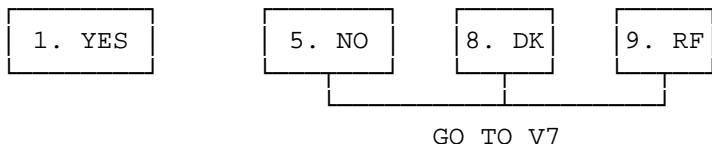

SECTION V: CAPITAL GAINS (November 11, 1994)

V5. About how much in total did you pay for this real estate? [DO NOT PROBE DK.]

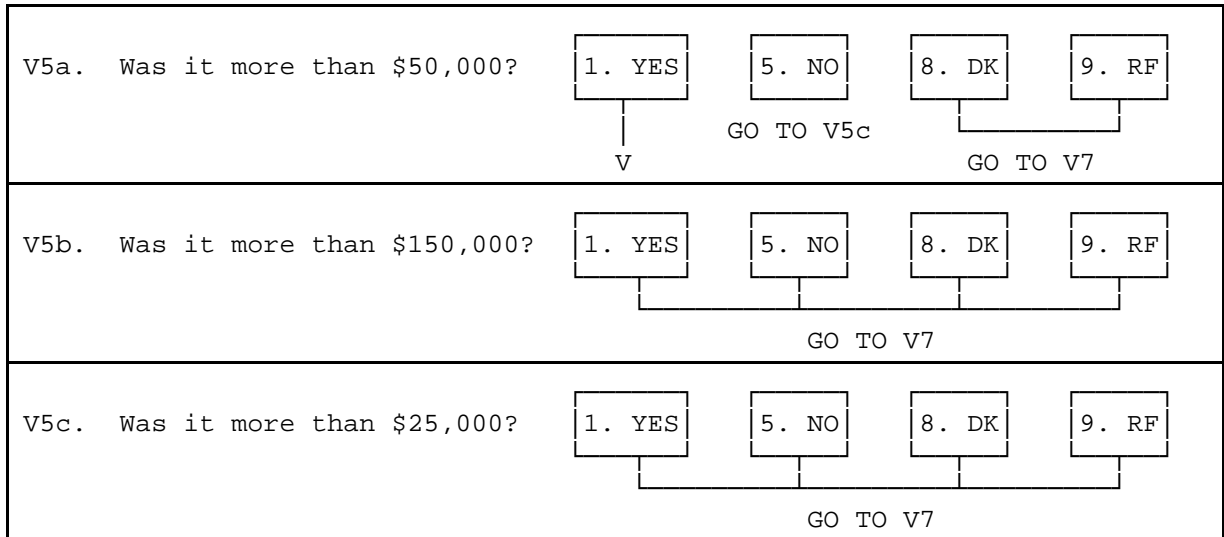
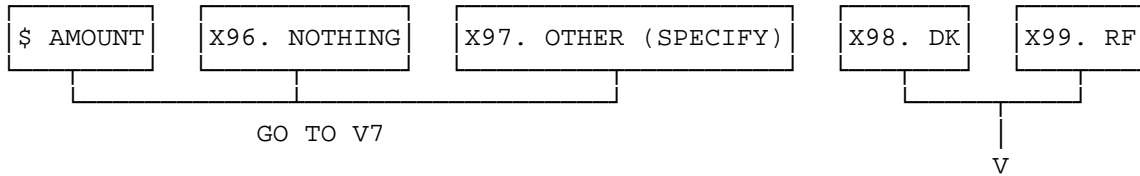

V6. Did you also buy any real estate of this sort since W1-MONTH W1-YEAR?

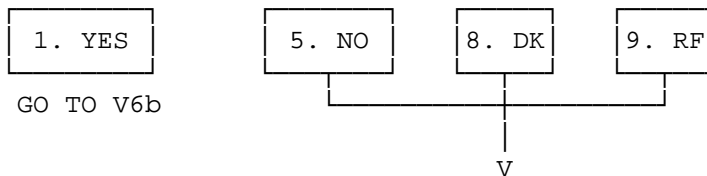

V6a. About how much in total was the dollar value of the real estate you sold since W1-MONTH W1-YEAR? [DO NOT PROBE DK.]

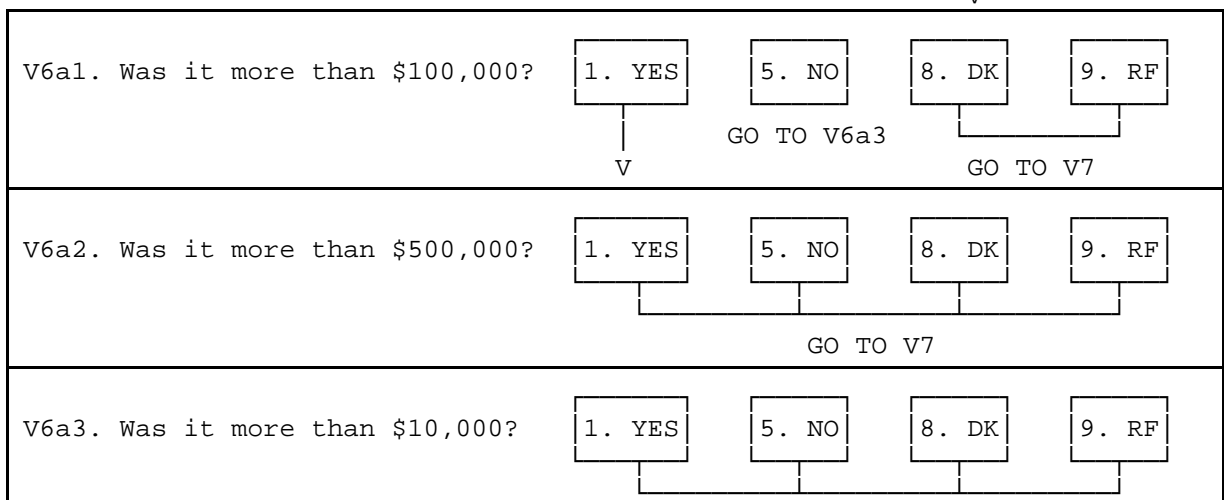
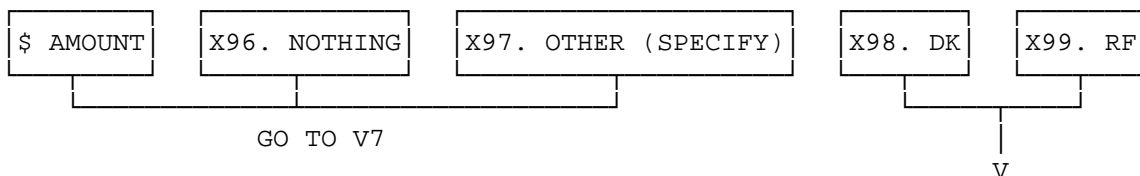

SECTION V: CAPITAL GAINS (November 11, 1994)

GO TO V7

V6b. Overall, was the dollar cost of the real estate you bought greater than the dollar value of what you sold (minus commissions), less than the value of what you sold, about equal, or what? [PLEASE PROBE IF DK]

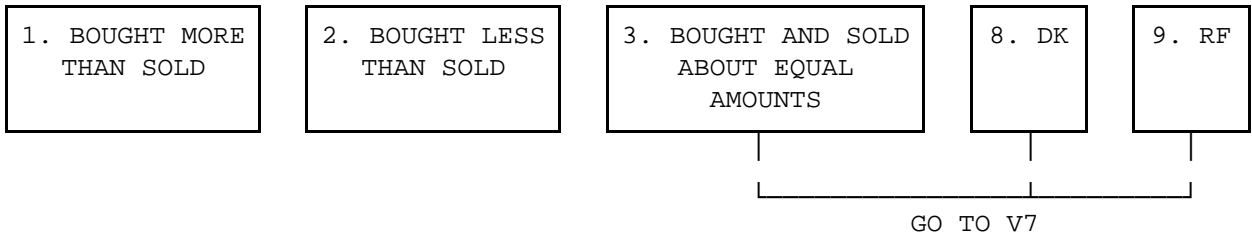

V6c. Roughly, about how much (V6b=1: more/V6b=2: less) did you buy than you sold? [DO NOT PROBE DK.]

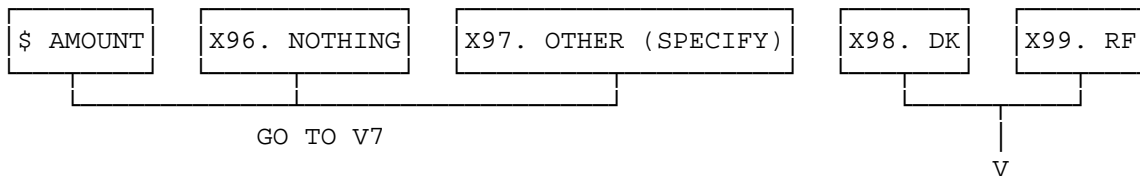

V6c1. Was it more than \$25,000?	1. YES	5. NO	8. DK	9. RF
		GO TO V6c3	GO TO V7	

V6c2. Was it more than \$100,000?	1. YES	5. NO	8. DK	9. RF
	GO TO V7			

V6c3. Was it more than \$5,000?	1. YES	5. NO	8. DK	9. RF
---------------------------------	--------	-------	-------	-------

SECTION V: CAPITAL GAINS (November 11, 1994)

V7. Since W1-MONTH W1-YEAR, did you [or your (husband/wife/partner)] make any major additions or home improvements to any real estate properties that you owned, other than your principal residence or second home? [DO NOT COUNT GENERAL MAINTENANCE OR UPKEEP.]

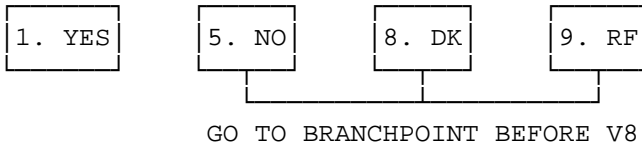

V7a. What was the dollar cost of these additions and improvements, plus the value of any work you may have done yourself? [DO NOT PROBE DK.]

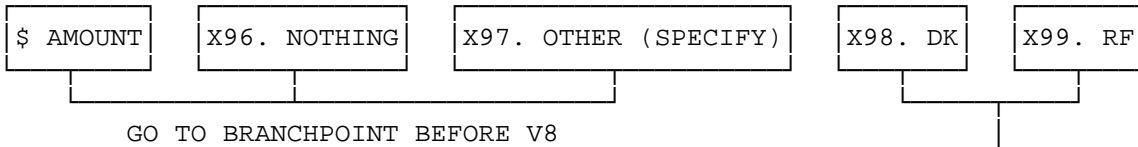

V7a1. Was it more than \$10,000?	1. YES	5. NO	8. DK	9. RF
	V	GO TO V7a3	GO TO BRCHPT BEFORE V8	
V7a2. Was it more than \$50,000?	1. YES	5. NO	8. DK	9. RF
	GO TO BRANCHPOINT BEFORE V8			
V7a3. Was it more than \$2,000?	1. YES	5. NO	8. DK	9. RF

BRANCHPOINT: IF R REPORTED NOT OWNING A BUSINESS IN WAVE II (K5=NO,DK,RF) AND WAVE I (M5=NO,DK,RF) — GO TO NEXT BRANCHPOINT

V8. Since W1-MONTH W1-YEAR, have you [or your (husband/wife/partner)] put personal funds into a privately held business, professional practice, partnership or farm that you own or share ownership in?

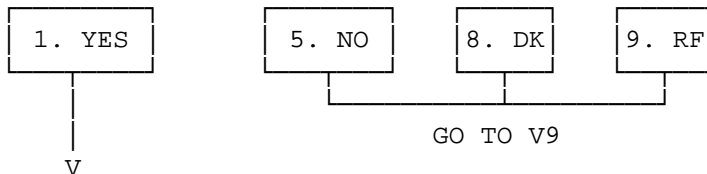

V8a. Altogether, about how much new money did you [or your (husband/wife/partner)] put into that, including any funds that you borrowed personally? [DO NOT PROBE DK.]

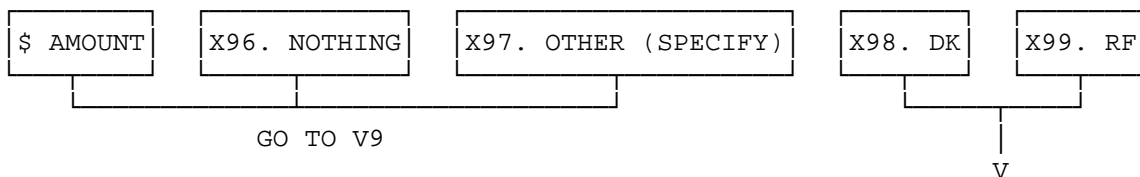

V8a1. Was it more than \$50,000?	1. YES	5. NO	8. DK	9. RF
	V	GO TO V8a3		GO TO V9
V8a2. Was it more than \$500,000?	1. YES	5. NO	8. DK	9. RF
	GO TO V9			
V8a3. Was it more than \$5,000?	1. YES	5. NO	8. DK	9. RF

SECTION V: CAPITAL GAINS (November 11, 1994)

V9. Since W1-MONTH W1-YEAR, have you [or your (husband/wife/partner)] sold part or all of any interest in a privately held business, professional practice, partnership or farm?

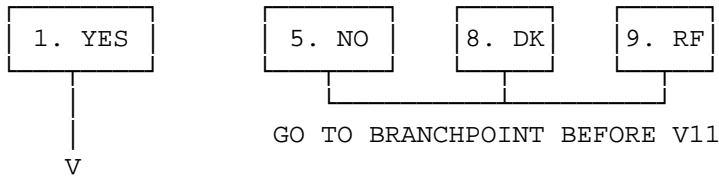

V9a. Altogether, about how much did you [or your (husband/wife/partner)] sell your interest for? (What was the selling price?) [IWER: WE WANT THE PRICE THE BUYER PAID. DO NOT PROBE DK.]

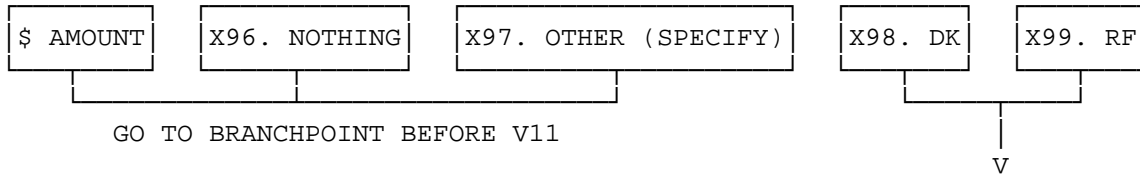

V9a1. Was it more than \$100,000?	1. YES	5. NO	8. DK	9. RF
	V	GO TO V9a3		GO TO BRCHPT BEFORE V11
V9a2. Was it more than \$1,000,000?	1. YES	5. NO	8. DK	9. RF
	GO TO BRANCHPOINT BEFORE V11			
V9a3. Was it more than \$10,000?	1. YES	5. NO	8. DK	9. RF

V9b. In what month and year did you sell that?

MONTH/YEAR

SECTION V: CAPITAL GAINS (November 11, 1994)

V13a. About how much did you [or your (husband/wife/partner)] (V13=1: put in/V13=2: take out)? [DO NOT PROBE DK.]

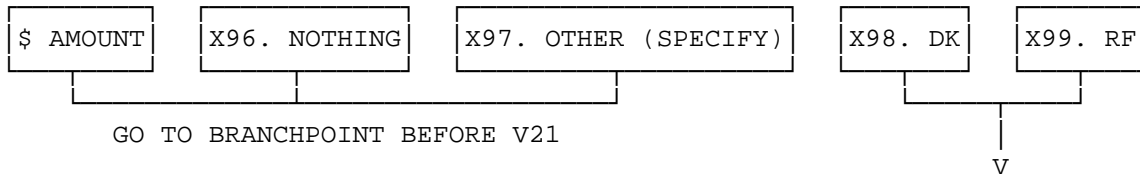

v13a1. Was it more than \$10,000?	1. YES	5. NO	8. DK	9. RF
	V	GO TO v13a3	GO TO BRANCHPOINT BEFORE V21	
v13a2. Was it more than \$50,000?	1. YES	5. NO	8. DK	9. RF
	GO TO BRANCHPOINT BEFORE V21			
v13a3. Was it more than \$2,500?	1. YES	5. NO	8. DK	9. RF

V14. Altogether, how much money (including any automatic reinvestment) did you [or your (husband/wife/partner)] put into that? [DO NOT PROBE DK.]

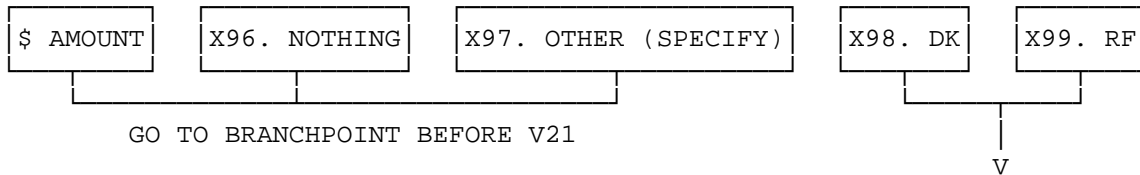

V14a. Was it more than \$25,000?	1. YES	5. NO	8. DK	9. RF
	V	GO TO V14c	GO TO BRANCHPOINT BEFORE V21	
V14b. Was it more than \$100,000?	1. YES	5. NO	8. DK	9. RF
	GO TO BRANCHPOINT BEFORE V21			
V14c. Was it more than \$5,000?	1. YES	5. NO	8. DK	9. RF
	GO TO BRANCHPOINT BEFORE V21			

V15. Since W1-MONTH W1-YEAR, have you [or your (husband/wife/partner)] sold any shares of stock in publicly held corporations or taken money out of any mutual funds, managed investment accounts or trusts?

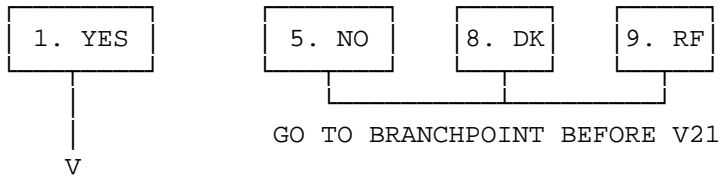

V15a. Altogether, how much money did you [or your (husband/wife/partner)] get from that? [DO NOT PROBE DK.]

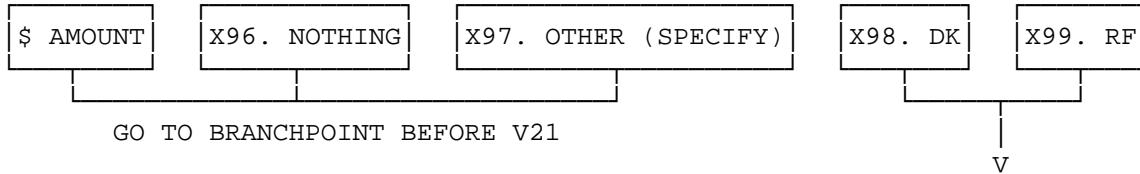

<p>V15a1. Was it more than \$25,000?</p>	<div style="display: flex; justify-content: space-around;"> <div style="border: 1px solid black; padding: 2px 10px;">1. YES</div> <div style="border: 1px solid black; padding: 2px 10px;">5. NO</div> <div style="border: 1px solid black; padding: 2px 10px;">8. DK</div> <div style="border: 1px solid black; padding: 2px 10px;">9. RF</div> </div>
	<p>GO TO V15a3</p> <p>GO TO BRANCHPOINT BEFORE V21</p>
<p>V15a2. Was it more than \$100,000?</p>	<div style="display: flex; justify-content: space-around;"> <div style="border: 1px solid black; padding: 2px 10px;">1. YES</div> <div style="border: 1px solid black; padding: 2px 10px;">5. NO</div> <div style="border: 1px solid black; padding: 2px 10px;">8. DK</div> <div style="border: 1px solid black; padding: 2px 10px;">9. RF</div> </div>
	<p>GO TO BRANCHPOINT BEFORE V21</p>
<p>V15a3. Was it more than \$5,000?</p>	<div style="display: flex; justify-content: space-around;"> <div style="border: 1px solid black; padding: 2px 10px;">1. YES</div> <div style="border: 1px solid black; padding: 2px 10px;">5. NO</div> <div style="border: 1px solid black; padding: 2px 10px;">8. DK</div> <div style="border: 1px solid black; padding: 2px 10px;">9. RF</div> </div>

[NOTE: THERE ARE NO QUESTIONS V17-V20.]

BRANCHPOINT: IF THE R GIVING THIS INTERVIEW IS A NEW SPOUSE/PARTNER, GO TO NEXT SECTION.

BRANCHPOINT: IF R HAS BEEN WIDOWED SINCE WAVE 1, OR IF THERE HAVE BEEN NO MOVERS INTO OR OUT OF THE HOUSEHOLD, GO TO NEXT SECTION.

V21. Sometimes changes in a family's savings or assets are due to people joining or leaving the family. Was there anyone living with you in WAVE I MONTH/YEAR who doesn't live with you now and who took \$5,000 or more in assets or debts away with them?

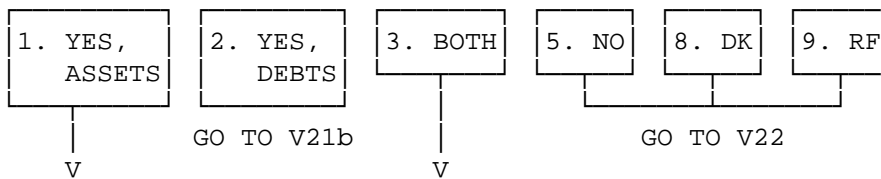

V21a. Altogether, what is the total dollar value of assets that were removed that way? [DO NOT PROBE DK.]

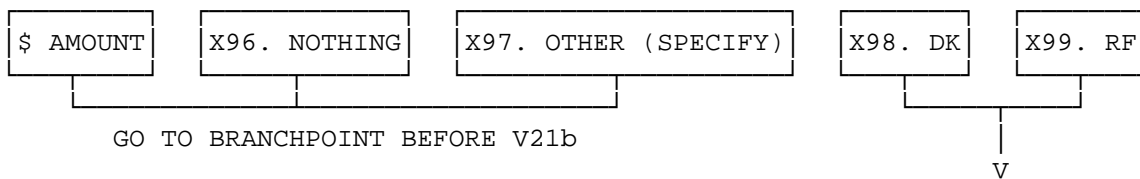

V21a1. Was it more than \$25,000?	1. YES	5. NO	8. DK	9. RF
	V	GO TO V21a3	GO TO BRCHPT BEFORE V21b	
V21a2. Was it more than \$100,000?	1. YES	5. NO	8. DK	9. RF
	GO TO BRANCHPOINT BEFORE V21b			
V21a3. Was it more than \$10,000?	1. YES	5. NO	8. DK	9. RF

BRANCHPOINT: IF THERE WAS A CHANGE IN ASSETS ONLY (V21=1), GO TO V22.

V21b. Altogether, what is the total dollar value of debts that were removed that way? [DO NOT PROBE DK.]

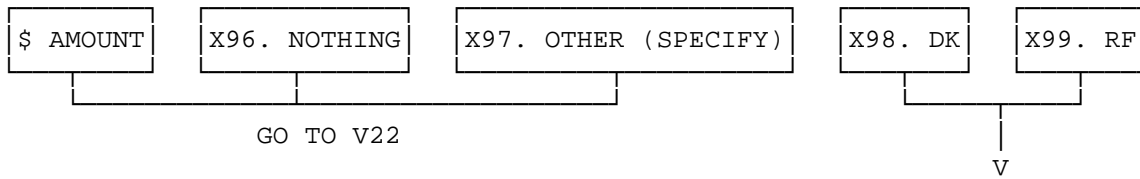

V21b1. Was it more than \$10,000?	1. YES	5. NO	8. DK	9. RF
	V	GO TO V21b3		GO TO V22
V21b2. Was it more than \$25,000?	1. YES	5. NO	8. DK	9. RF
	GO TO V22			
V21b3. Was it more than \$5,000?	1. YES	5. NO	8. DK	9. RF

V22. Is there anyone in your family living with you now who has joined the family since WAVE I MONTH/YEAR and who had \$5,000 or more in assets or debts at the time they joined the family?

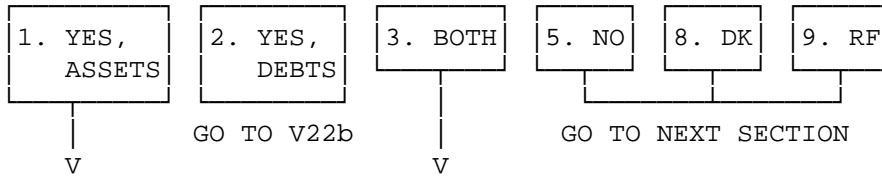

V22a. Altogether, what is the total dollar value of assets that were brought into the family in that way? [DO NOT PROBE DK.]

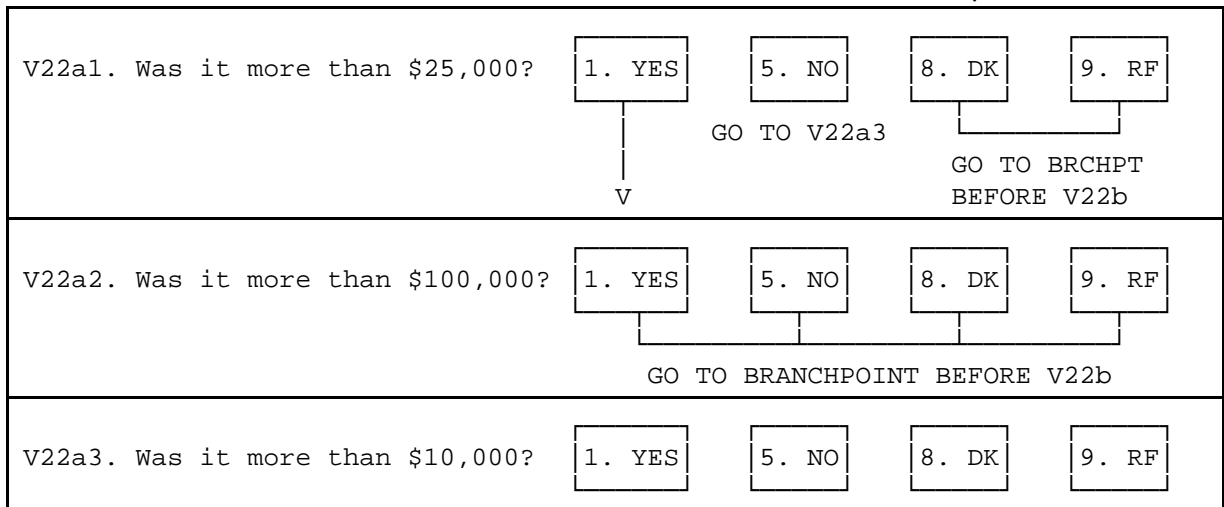
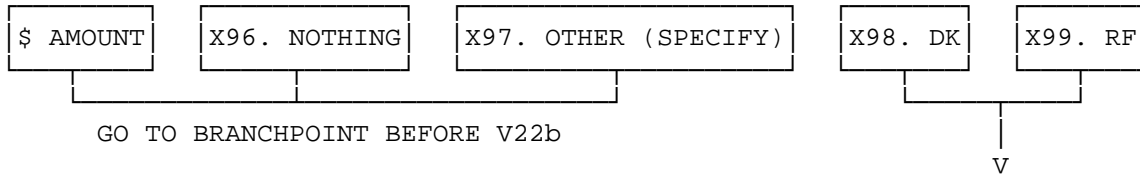

BRANCHPOINT: IF THERE WAS A CHANGE IN ASSETS ONLY (V22=1), GO TO NEXT SECTION.

V22b. Altogether, what is the total dollar value of debts that were brought into the family in that way? [DO NOT PROBE DK.]

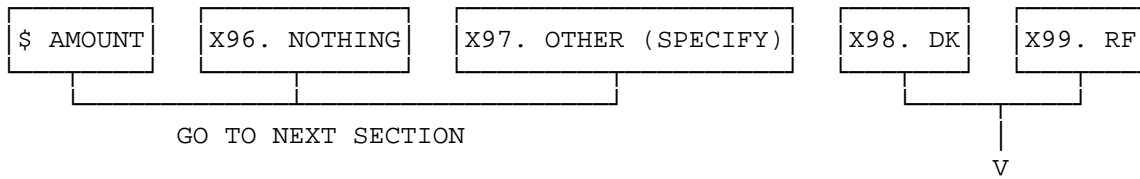

V22b1. Was it more than \$10,000?	<input type="checkbox"/> 1. YES	<input type="checkbox"/> 5. NO	<input type="checkbox"/> 8. DK	<input type="checkbox"/> 9. RF
	↓ V	GO TO V22b3	GO TO NEXT SECTION	
V22b2. Was it more than \$25,000?	<input type="checkbox"/> 1. YES	<input type="checkbox"/> 5. NO	<input type="checkbox"/> 8. DK	<input type="checkbox"/> 9. RF
	GO TO NEXT SECTION			
V22b3. Was it more than \$5,000?	<input type="checkbox"/> 1. YES	<input type="checkbox"/> 5. NO	<input type="checkbox"/> 8. DK	<input type="checkbox"/> 9. RF